

SCTE • ISBE[®]

S T A N D A R D S

ENGINEERING COMMITTEE
Interface Practices Subcommittee

SCTE STANDARD

SCTE 48-3 2018

**Test Procedure for Measuring Shielding Effectiveness
of Coaxial Cable and Connectors Using the GTEM Cell**

NOTICE

The Society of Cable Telecommunications Engineers (SCTE) / International Society of Broadband Experts (ISBE) Standards and Operational Practices (hereafter called “documents”) are intended to serve the public interest by providing specifications, test methods and procedures that promote uniformity of product, interchangeability, best practices and ultimately the long-term reliability of broadband communications facilities. These documents shall not in any way preclude any member or non-member of SCTE•ISBE from manufacturing or selling products not conforming to such documents, nor shall the existence of such standards preclude their voluntary use by those other than SCTE•ISBE members.

SCTE•ISBE assumes no obligations or liability whatsoever to any party who may adopt the documents. Such adopting party assumes all risks associated with adoption of these documents, and accepts full responsibility for any damage and/or claims arising from the adoption of such documents.

Attention is called to the possibility that implementation of this document may require the use of subject matter covered by patent rights. By publication of this document, no position is taken with respect to the existence or validity of any patent rights in connection therewith. SCTE•ISBE shall not be responsible for identifying patents for which a license may be required or for conducting inquiries into the legal validity or scope of those patents that are brought to its attention.

Patent holders who believe that they hold patents which are essential to the implementation of this document have been requested to provide information about those patents and any related licensing terms and conditions. Any such declarations made before or after publication of this document are available on the SCTE•ISBE web site at <http://www.scte.org>.

All Rights Reserved

© Society of Cable Telecommunications Engineers, Inc. 2018
140 Philips Road
Exton, PA 19341

Table of Contents

Title	Page Number
NOTICE	2
1. Introduction	5
1.1. Executive Summary	5
1.2. Scope	5
1.3. Benefits	5
1.4. Areas for Further Investigation or to be Added in Future Versions	5
2. Normative References	5
2.1. SCTE References	6
2.2. Standards from Other Organizations	6
2.3. Published Materials	6
3. Informative References	6
3.1. SCTE References	6
3.2. Standards from Other Organizations	6
3.3. Published Materials	6
4. Compliance Notation	7
5. Abbreviations and Definitions	7
5.1. Abbreviations	7
5.2. Definitions	7
6. Procedure	8
6.1. Key Performance Metrics	8
6.2. Required Equipment	8
6.3. Calibration and Equipment Preparation	9
6.4. Detailed Procedure	12
6.4.1. Terminator sweep	12
6.4.2. Unshielded cable sample	12
6.4.3. Unshielded cable sample setup	13
6.4.4. Unshielded cable coupling loss measurement	13
6.4.5. Calculation of dynamic range	14
6.4.6. Coupling loss measurement of shielded cable	15
6.4.7. Shielded cable coupling loss measurement	16
6.4.8. Shielding effectiveness calculation	17
6.5. Recording of Results	17
6.6. Troubleshooting	18

List of Figures

Title	Page Number
FIGURE 1 – A FOAMED PLASTIC (POLYETHYLENE, POLYSTYRENE) ARCH TO SUPPORT THE CABLE DURING TESTING	9
FIGURE 2 – TEST CONFIGURATION USING VECTOR NETWORK ANALYZER	11
FIGURE 3 – TEST CONFIGURATION USING SPECTRUM ANALYZER	12
FIGURE 4 – UNSHIELDED CABLE SAMPLE	13
FIGURE 5 – CUTAWAY OF GTEM ILLUSTRATING THE LOCATION OF THE TEST SAMPLE	13
FIGURE 6 – DYNAMIC RANGE PLOT USING UNSHIELDED SAMPLE VS TERMINATOR MEASUREMENT	14
FIGURE 7 – SHIELDED CABLE SAMPLE (WHEN INCLUDING COAXIAL CABLE CONNECTORS IN MEASUREMENT)	15

FIGURE 8 – SHIELDED CABLE SAMPLE (WHEN REMOVING COAXIAL CABLE CONNECTORS FROM MEASUREMENT) 15

FIGURE 9 – SAMPLE S.E. PLOT 18

FIGURE 10 – GTEM FEED THROUGH PANEL WITH DIMENSIONS (DIMENSIONS WILL VARY WITH GTEM SIZE) 20

FIGURE 11 – A TYPICAL FEED-THRU ADAPTER SETUP USED ON THE GTEM FLOOR 21

FIGURE 12 – TYPICAL FEED-THRU CONFIGURATIONS 22

List of Tables

Title	Page Number
TABLE 1 – TEST EQUIPMENT LIST	8

1. Introduction

1.1. Executive Summary

The shielding attributes of components in a CATV system are critical to system performance. Ingress and egress issues can have detrimental effects on the overall performance of the system from both regulatory and quality perspectives.

Ingress issues can cause problems with television picture quality, and the effective transfer of data by allowing spurious signal into the system.

Egress issues can allow signals captured in the system to leak out and possibly interfere with wireless communications which utilize the same frequencies as those signals being leaked from the system.

It is the goal of this document to address the coaxial cables and connectors in the system, and how to properly gauge their performance in this critical area.

1.2. Scope

This document details the procedure for measuring the Shielding Effectiveness (S.E.) of coaxial cable and connectors using the Gigahertz Transverse ElectroMagnetic (GTEM) cell. More particularly, this procedure applies to measuring the S.E. of 75 Ohm braided coaxial drop cables and connectors presently used within the broadband communications industry. S.E. measurements can be performed with or without the affixing coaxial connectors removed from the measurement.

1.3. Benefits

This procedure exists in order to provide a standard method of testing between laboratories performing Shielding Effectiveness tests. When utilized this procedure helps to ensure confidence in results when published.

1.4. Areas for Further Investigation or to be Added in Future Versions

Future revisions of this document may build upon the work started here by increasing the understanding of:

- Variability of data between GTEM Cell systems with varied “uniform field” sizes.
- The affects of location differences between bare wire and shielded samples within the GTEM cell.

2. Normative References

The following documents contain provisions, which, through reference in this text, constitute provisions of this document. At the time of Subcommittee approval, the editions indicated were valid. All documents are subject to revision; and while parties to any agreement based on this document are encouraged to investigate the possibility of applying the most recent editions of the documents listed below, they are reminded that newer editions of those documents might not be compatible with the referenced version.

2.1. SCTE References

- No SCTE references are applicable.

2.2. Standards from Other Organizations

- No normative references are applicable.

2.3. Published Materials

- No normative references are applicable.

3. Informative References

The following documents might provide valuable information to the reader but are not required when complying with this document.

3.1. SCTE References

- No informative references are applicable.

3.2. Standards from Other Organizations

- **IEC 61000-4-20** 2nd Edition, August 1, 2010. Electromagnetic compatibility (EMC) – Part 4-20: Testing and measurement techniques – Emission and immunity testing in transverse electromagnetic (TEM) waveguides.

3.3. Published Materials

- A GTEM BEST PRACTICE GUIDE – APPLYING IEC 61000-4-20, TO THE USE OF GTEM CELLS. A. Nothofer, M.J. Alexander, National Physical Laboratory, Teddington, UK, D. Bozec, D. Welsh, L. Dawson, L. McCormack, A.C. Marvin, University of York, Heslington, UK(Principal contact: nothofer@ieee.org)
- <http://ieeexplore.ieee.org/search/searchresult.jsp?newsearch=true&queryText=GTEM>
Multiple helpful documents

4. Compliance Notation

<i>shall</i>	This word or the adjective “ required ” means that the item is an absolute requirement of this document.
<i>shall not</i>	This phrase means that the item is an absolute prohibition of this document.
<i>forbidden</i>	This word means the value specified shall never be used.
<i>should</i>	This word or the adjective “ recommended ” means that there may exist valid reasons in particular circumstances to ignore this item, but the full implications should be understood and the case carefully weighted before choosing a different course.
<i>should not</i>	This phrase means that there may exist valid reasons in particular circumstances when the listed behavior is acceptable or even useful, but the full implications should be understood and the case carefully weighed before implementing any behavior described with this label.
<i>may</i>	This word or the adjective “ optional ” means that this item is truly optional. One vendor may choose to include the item because a particular marketplace requires it or because it enhances the product, for example; another vendor may omit the same item.
<i>deprecated</i>	Use is permissible for legacy purposes only. Deprecated features may be removed from future versions of this document. Implementations should avoid use of deprecated features.

5. Abbreviations and Definitions

5.1. Abbreviations

GTEM	Gigahertz Transverse Electro Magnetic
dBm	Decibel-milliwatt
Hz	hertz
kHz	Kilohertz 1 x 10 ³ Hz
MHz	Megahertz 1 x 10 ⁶ Hz
GHz	Gigahertz 1 x 10 ⁹ Hz
λ	Wavelength
RF	Radio frequency
DUT	Device under test
SCTE	Society of Cable Telecommunications Engineers

5.2. Definitions

Shielding Effectiveness	<p>When using the S.E. measurement procedure herein, the S.E. is defined as the level difference in dB between the RF energy coupled with and without the shield in place, therefore, measuring the RF shielding effectiveness of the Device Under Test (DUT). The S.E. of the DUT expressed as the average value across the entire range of measured frequencies.</p> <p>Note: Worst case values may also be used, however when documenting in this manner, smoothing or averaging of data shall be used.</p>
-------------------------	--

6. Procedure

6.1. Key Performance Metrics

Metrics key to this procedure and measurement system are as follows:

- Dynamic range – The dynamic range of the measurement system should be a minimum of 130dB.

6.2. Required Equipment

Table 1 – Test equipment list

ITEM NO.	QTY	Description	Manufacturer and Model No./P/N
1	1	Gigahertz Transverse Electromagnetic (GTEM) Cell with 50 Ohm Type N interface	EMC Test Systems Model 5305 or equivalent
2a	1	Spectrum Analyzer with tracking generator with 50 Ohm Type N interface	Keysight N9000A with option T03 or equivalent
2b	1	Vector Network Analyzer with 50 Ohm Type N interface	Keysight E5071C or equivalent with option 240 or equivalent
3	1	RF Amplifier, 10 Watt (+40 dBm), 5 – 1002 MHz with 50 Ohm Type N interface	Amplifier Research Model 10WD1000B or equivalent
4	Varied based on values	RF Amplifier, 20 Watt (+43 dBm), 1 – 4.2 GHz with 50 Ohm Type N interface (Optional For higher frequencies)	Amplifier Research Model 20S1G4 or equivalent
5	1	50 to 75 Ohm minimum loss pad (DC – 3GHz)	Keysight 11852B or equivalent
6	1	Pre-amp ¹ (300kHz – 1GHz)	L-3 Narda-MITEQ Model AM-1594-1000 or equivalent
7	1	Pre-amp ¹ (300kHz – 3GHz) (Optional for higher frequencies)	L-3 Narda-MITEQ Model AM-1594-3000 or equivalent
8	1	RF Attenuators (DC to 3GHz)	Attenuator values will vary based field strength inside GTEM. Attenuators are used for analyzer protection only.
9	1	DC Power filter (Optional)	Any low pass filter to ensure clean DC power to preamp
10	1	EMI box (Optional)	For EMI protection of preamp, adapters, attenuators etc. below GTEM
11	1	Computer (Optional) ²	
12	1	Foam support	See Figure 1 below. Dimensions will vary based on GTEM dimensions

¹ A pre-amp is optional for drop cables, but is strongly recommended for highly shielded drop.

² A computer is optional, but is strongly recommended in order to automate the measurement process to reduce measurement time and increase measurement accuracy. The spectrum analyzer or network analyzer and amplifier, if fitted with a proper I/O port such as IEEE 488 (HP-IB) or RS 232 can be operated remotely via the computer acting as the system controller. Use of a computer also enables data processing, display and storage.

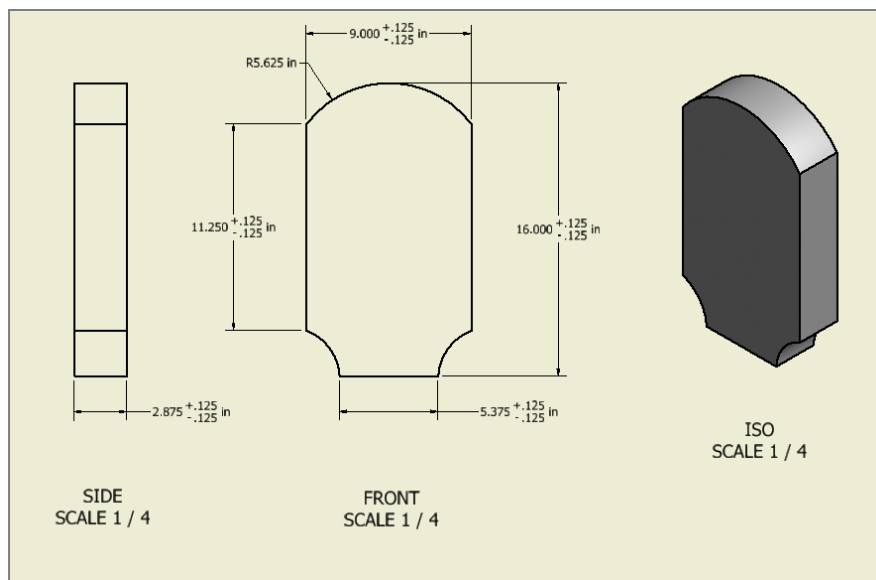

Figure 1 – A foamed plastic (polyethylene, polystyrene) arch to support the cable during testing

6.3. Calibration and Equipment Preparation

Data points – The number of measurement samples taken is at the discretion of the Engineer performing the test, however, as a minimum requirement there will be at least one sample point every 5 MHz (i.e. 5, 10, 15, upper frequency limit).

When testing frequencies above 1GHz, it may be necessary to use multiple amplifiers to cover the entire range. The following items should be considered when using multiple amplifiers.

- Safety consideration must be taken into account if manually switching between amplifiers, and the amplifier outputs must be off before switching them.
- When using data collecting and control software for a spectrum analyzer, and manually switching amplifiers there should be a pause feature to stop the sweep at the correct frequency to switch amps and then continue sweep once correct amp is in place.
- Be sure to verify that all supporting equipment, i.e. pre amp, attenuators etc. are correctly chosen to cover the entire frequency range in question.

RF power level – As this test is designed as a comparison of shielded vs unshielded cable, an exact field strength is not stated. It is necessary however to have enough energy in the GTEM as is necessary to achieve sufficient dynamic range for the measurements being made.

Attenuator characterization – Any attenuators that may be inserted or removed from the measurement during the measurement process shall be characterized and data stored for later use during S.E. calculations.

Preamp characterization – A preamp that may be inserted or removed from the measurement during the measurement process shall be characterized and data stored for later use during S.E. calculations.

Analyzer settings:

- Vector Network Analyzer
 - IF Bandwidth 100Hz maximum
 - Calibration – Through and isolation

- Spectrum Analyzer
 - Resolution Bandwidth 100Hz maximum
 - 1 second settling duration

A system verification shall be performed by removing the GTEM cell, any attenuators, and preamp from the measurement and connecting together all the test leads and adapters used. It is recommended that this system verification be performed without the use of the RF amplifier to ensure no damage to the analyzer occurs.

No aluminum foils or ferrites shall be present in the test setup that could affect the test result, test connector / adapter assembly should be soldered to achieve good shielding instead.

Note: If the insertion loss measurement is greater than 10 dB, there may be a faulty component in-line and the dynamic range of the S.E. measurement may be reduced.

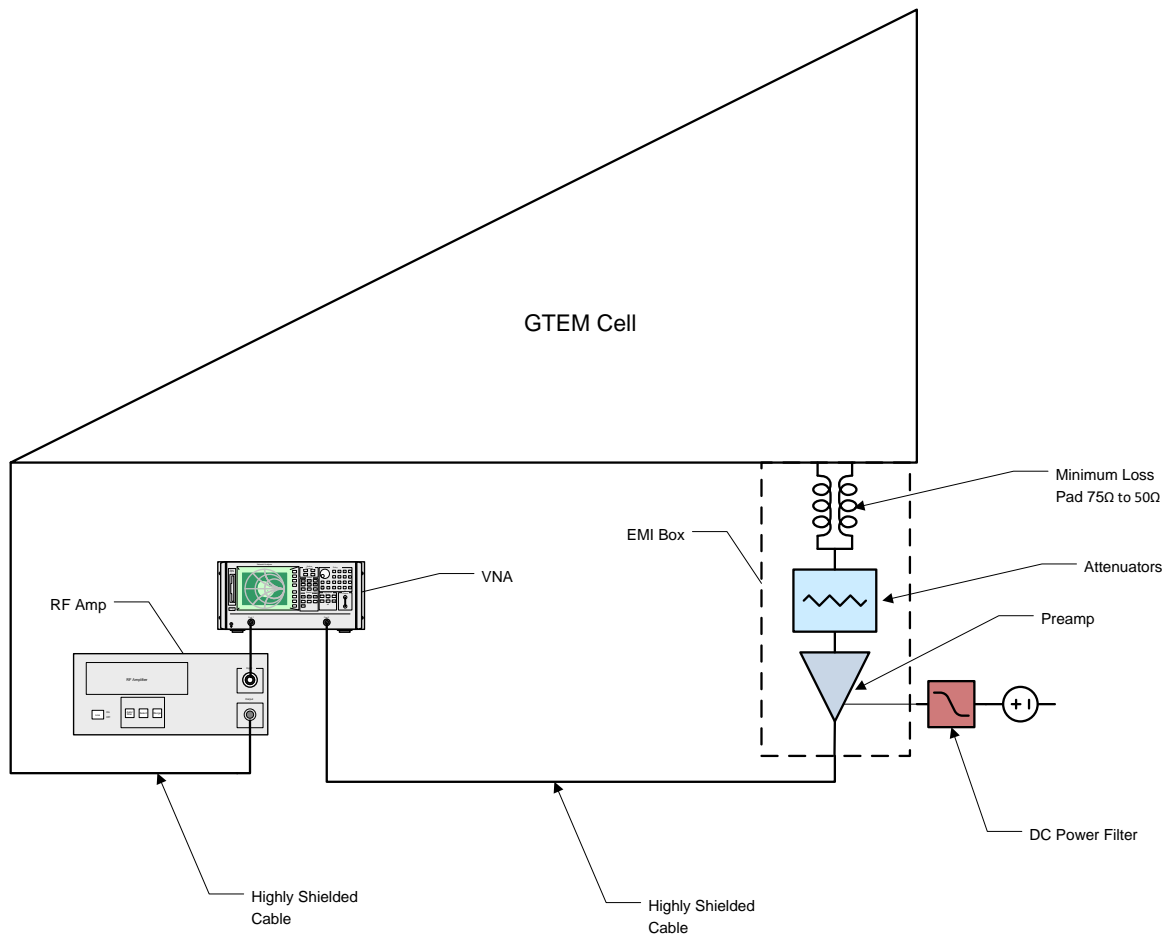

Figure 2 – Test Configuration using Vector Network Analyzer

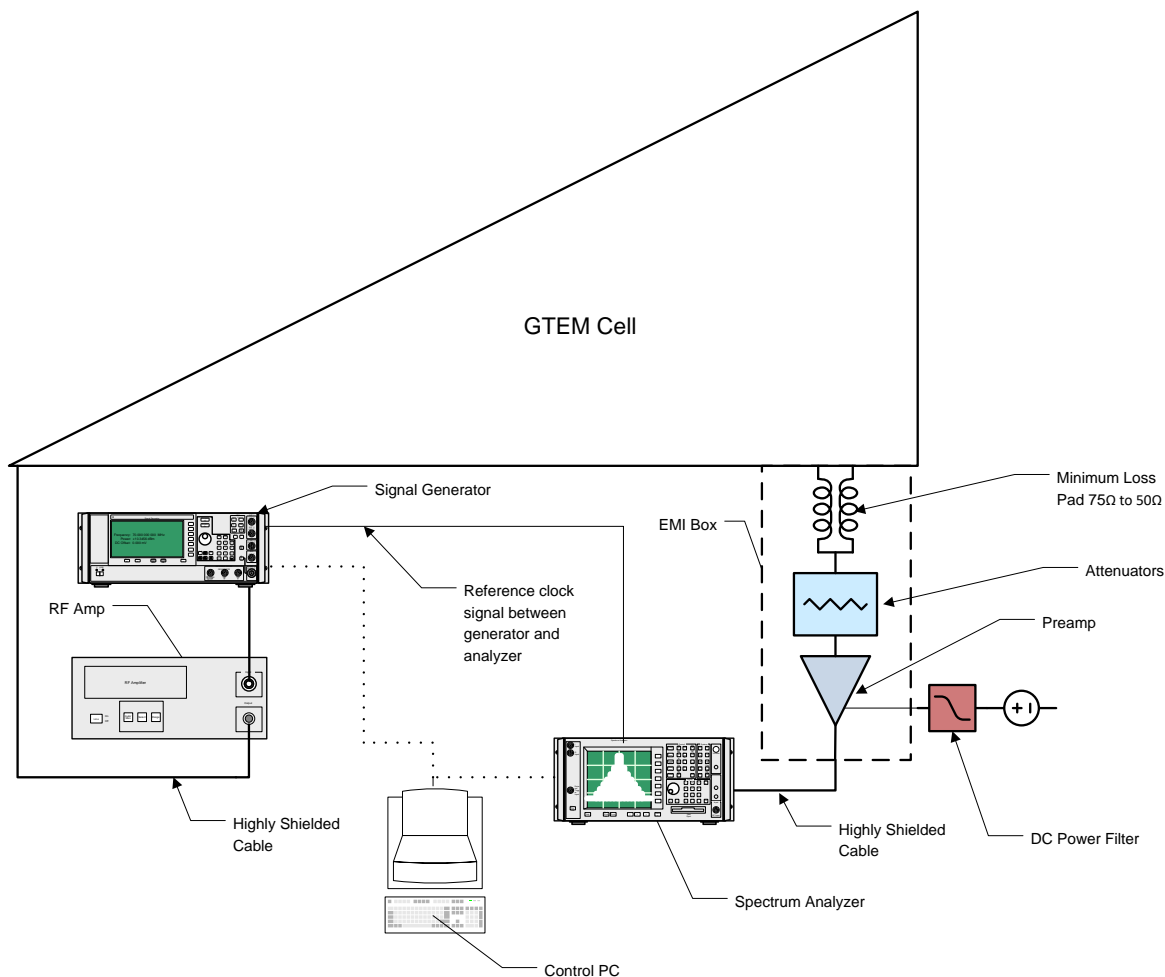

Figure 3 – Test Configuration using Spectrum Analyzer

6.4. Detailed Procedure

6.4.1. Terminator sweep

With equipment connected as shown in Figures 2 or 3, place a terminator on the adapter at the floor of the GTEM where signal return to analyzer is. Perform a full sweep of the system and store the data for later use in calculating dynamic range.

6.4.2. Unshielded cable sample

Whether or not the coaxial cable connectors are to be included in the S.E. measurement, the verification sample shall consist of a 1 meter (3.28 ft) length of core (inner conductor and dielectric insulation only) with the appropriate coaxial cable connectors fitted to each end as shown in Figure 4 below. The connectors are typically Type F male.

(Helpful Note: A layer of tape may be applied to the end of the core, in order to simulate the foil tape so that the F connector will fit snug. No compression is necessary, so the connectors are reusable.)

NOTE: The dielectric and center conductor size and type of the unshielded core should be comparable to the size and type of the dielectric and center conductor of the shielded DUT.

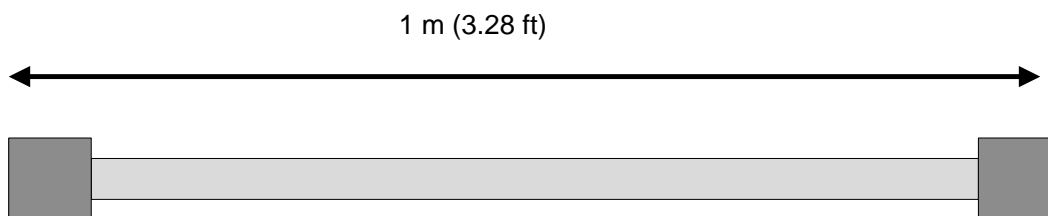

Figure 4 – Unshielded Cable Sample

6.4.3. Unshielded cable sample setup

The unshielded cable sample shall be installed within the GTEM cell as shown in Figure 5. The coaxial cable connectors shall be attached to the adapter interfaces on the feed-thru panel located in the center of the GTEM floor (since feed-thru panels are not standard equipment on some models of GTEM cells, holes may be placed on the floor of the GTEM cell centered on the access door and centerline of the cell, and the sample orientation should be in keeping with the diagram in Figure 5. One of the feed-thru adapters will be terminated with a 75 Ohm load and the other will be connected to the test lead that returns to the receiver of the spectrum analyzer or network analyzer (the connections to the feed-thru adapters are interchangeable based on the symmetry of the DUT in the GTEM). For typical adapter feed-thru configurations, refer to Figure 11.

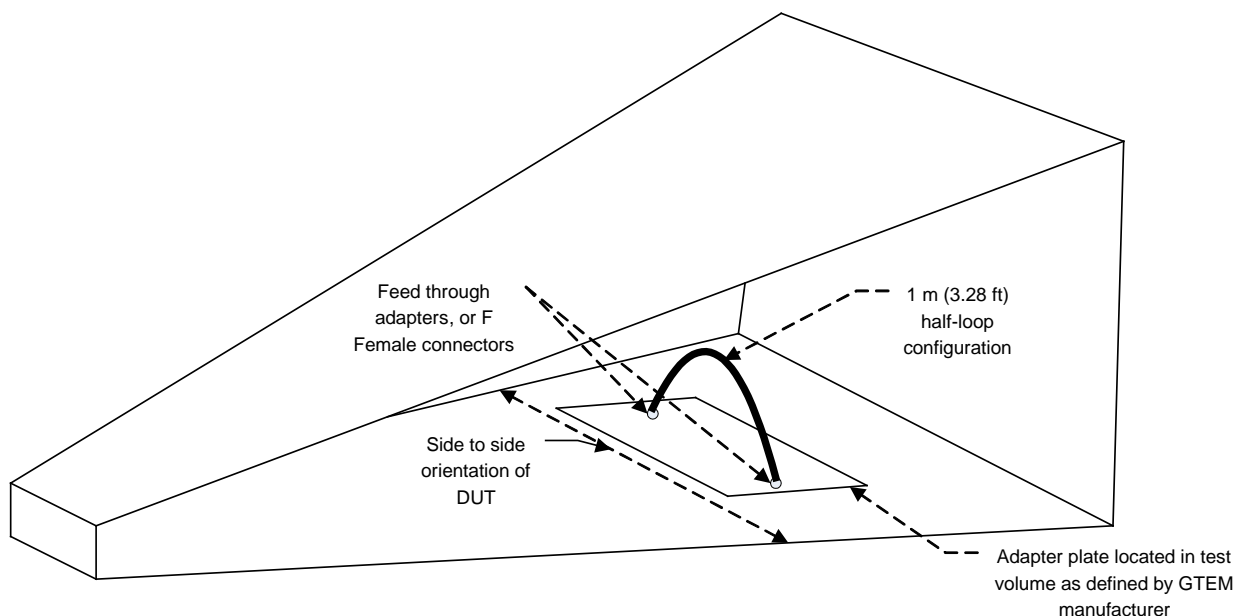

Figure 5 – Cutaway of GTEM illustrating the location of the test sample

6.4.4. Unshielded cable coupling loss measurement

Similar to the System Verification, it is recommended that the coupling loss measurement of the unshielded cable be performed without using the RF amplifier, or

adding attenuation to the system in order to avoid damage to measurement equipment. Perform a coupling loss measurement of the unshielded cable and store the data to be used later for calculating the S.E. of the cable under test, and dynamic range.

Figure 6 illustrates a sample coupling loss plot of the unshielded cable under test. This trace is a measurement of the RF voltage loss between the voltage input to the GTEM cell and the voltage coupled by the unshielded cable under test.

6.4.5. Calculation of dynamic range

Recall the stored data from the terminator sweep in a spreadsheet. Then recall the stored data from the unshielded cable coupling loss measurement. Be sure to account for any attenuation that may have been added during the unshielded cable sweep if used.

The dynamic range is the difference between the terminator and the unshielded cable measurements. The dynamic range should be 130dB.

Figure 6 represents a plot of the unshielded cable and terminator data with dynamic range represented.

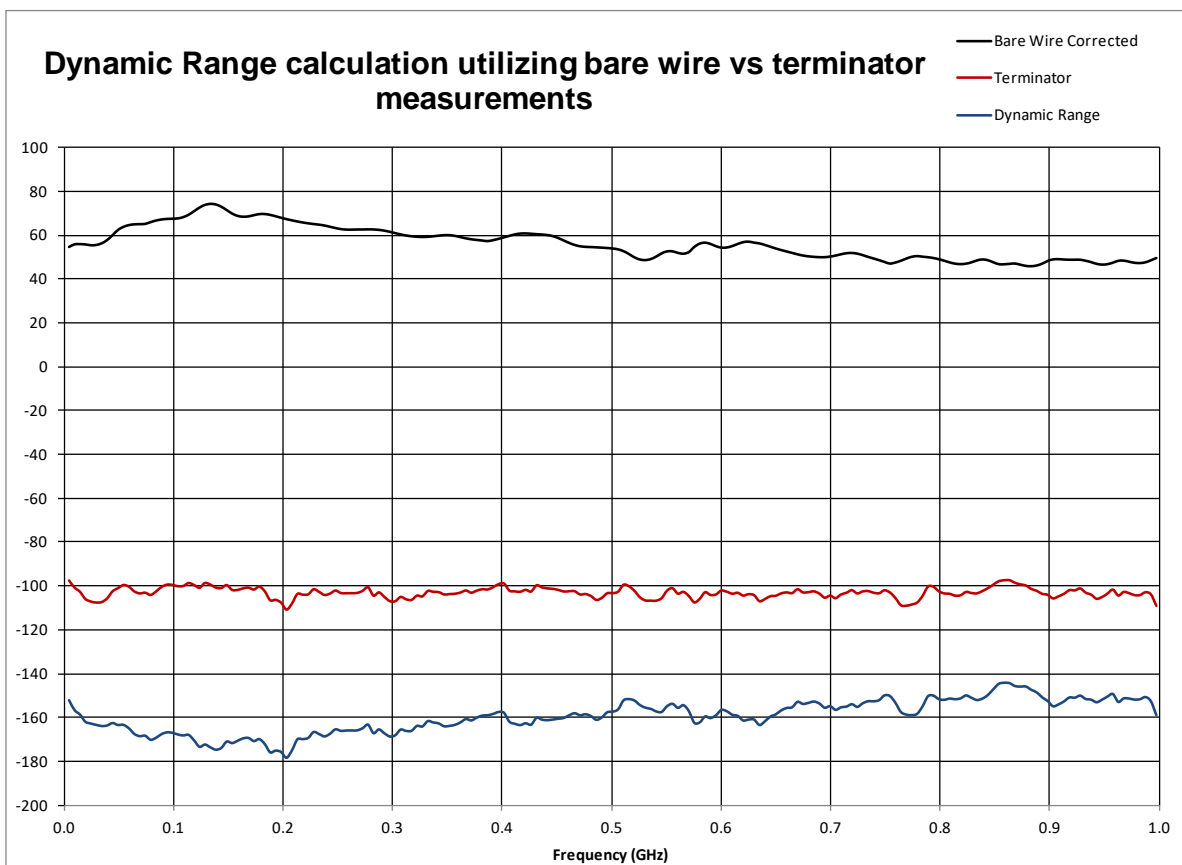

Figure 6 – Dynamic range plot using unshielded sample vs terminator measurement

6.4.6. Coupling loss measurement of shielded cable

6.4.6.1. **Shielded cable with connectors in measurement** - When including the coaxial cable connectors within the S.E. measurement, the shielded cable sample under test shall consist of a 1 meter (3.28 ft) length with the appropriate coaxial cable connectors attached to each end per the manufacturer’s instructions as shown in Figure 7 below. The cable outer conductor shield and jacket shall remain undisturbed.

When including the coaxial cable connectors within the S.E. measurement, the shielded cable sample shall be installed within the GTEM cell identically to how the unshielded cable sample was installed in Figure 5 and shall use the same feed-thru adapter configurations.

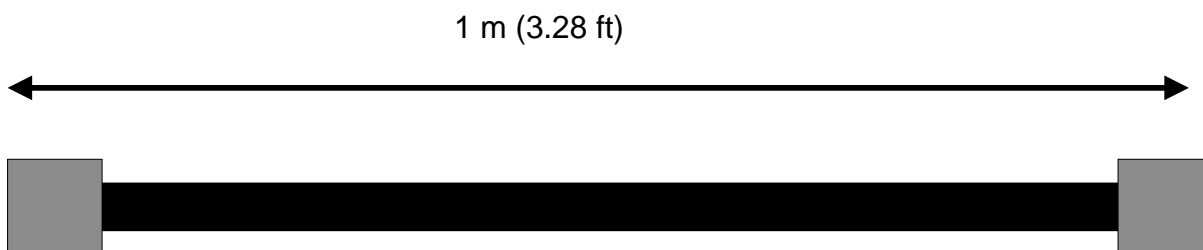

Figure 7 – Shielded cable sample (When including coaxial cable connectors in measurement)

6.4.6.2. **Shielded cable with connectors removed from measurement** - The connectors may be removed from the measurement if necessary. When removing the coaxial cable connectors from the S.E. measurement, the shielded cable sample under test shall consist of a 1.52 - 2.13 m (5 - 7 ft) length with two sections of jacket removed as shown in Figure 8 below.

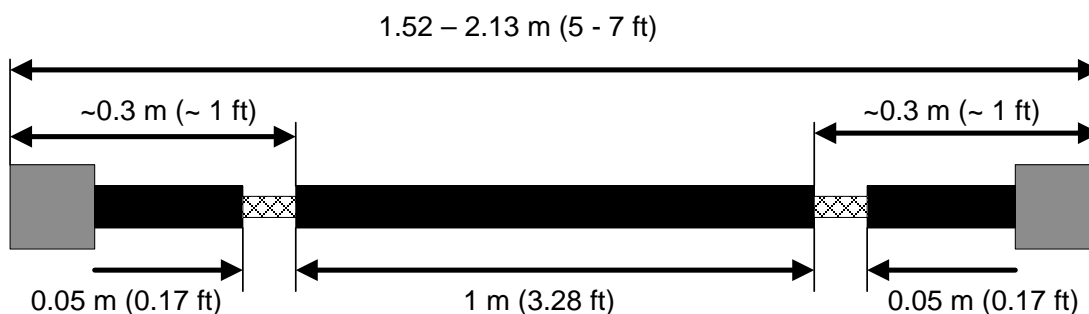

Figure 8 – Shielded cable sample (When removing coaxial cable connectors from measurement)

The shielded cable sample in Figure 8 is a total of 1.52-2.13m (5-7 ft) in length. Two inches of jacket are removed at the two locations specified from the drawing, in order to

accommodate the cable feed-thrus in the GTEM floor. Therefore, a 1 meter (3.28 ft) section of the shielded cable will remain inside the GTEM cell after being installed.

Even though the coaxial cable connectors are outside of the GTEM cell and isolated from the electromagnetic fields in the GTEM, the coaxial cable connectors should still be compressed in order to prevent intrusion of random noise from outside the GTEM.

NOTE: It is important to be careful not to disturb the cable's outer conductor shield, when removing the sections of jacket from the cable.

NOTE: It may not be possible to remove the jacket of tri-shield cables with bonded outer tapes without damaging the outer tape and invalidating the results. In this case, use method 6.4.6.1.

When removing the coaxial cable connectors from the S.E. measurement, the adapter feed-thrus on the GTEM floor, shown in Figure 11, need to be replaced with the appropriate sized cable feed-thru. It is recommended that interchangeable feed-thru panels be used to switch the size of the cable feed-thru. Refer to Figure 12 for a drawing of a typical cable feed-thru.

Once the appropriate sized cable feed-thrus are in place, the shielded cable sample shall be installed as shown in Figure 5. The cable feed-thrus are used to clamp around the outer conductor shield of the cable sample where the two-inch sections of jacket have been removed.

Note: feedthru design (example Fig 11) is critical to achieving accurate measurements. A perfect R.F. seal is required to the GTEM floor. Do not use a washer inside the GTEM between the feedthru sealing flange and the floor. Make sure the metal surfaces are bright and clean (no paint or corrosion).

In doing this, a 1 meter (3.28 ft) length middle section of the cable sample will remain inside the GTEM cell and the two ends of the cable that are approximately 0.30 m (12 inches) in length will extend outside the GTEM cell through the floor.

The cable sample ends shall be terminated similarly to how the unshielded cable sample was terminated in section 6.4.3, however, this sample will be terminated outside the GTEM cell.

6.4.7. Shielded cable coupling loss measurement

The coupling loss measurement of the shielded cable is typically performed with the use of the amplifier in-line as shown in Figures 2 or 3. Perform a coupling loss measurement of the shielded cable and store the data to be used later for calculating the S.E. of the cable under test.

For highly shielded drop cable it is recommended that the pre-amp be used in the measurement to ensure proper dynamic range of the test equipment. When a pre-amp is used, it shall be inserted at the input of the spectrum/network analyzer.

6.4.8. Shielding effectiveness calculation

The S.E. of the cable under test is the level difference in dB between the energy coupled by the unshielded and shielded cable sample and can be calculated from the following equation:

S.E (Preamp removed from unshielded cable) = (Coupling loss of shielded cable + amplifier gain) – (Coupling loss of unshielded cable)

S.E (Attenuation used with unshielded cable and preamp left in) = (Coupling loss of shielded cable) – (Coupling loss of unshielded cable + attenuation)

Figure 9 illustrates a sample S.E. plot and displays the average S.E. values.

NOTE: In the S.E. equation above, all values are considered absolute. Also, The S.E. of the DUT expressed as the average value across the entire range of measured frequencies.

Note: Worst case values may also be used, however when documenting in this manner, smoothing or averaging of data shall be used.

6.5. Recording of Results

The graph below is an example a S.E. plot.

Tabular data recorded is averaged, and the average value is reported.

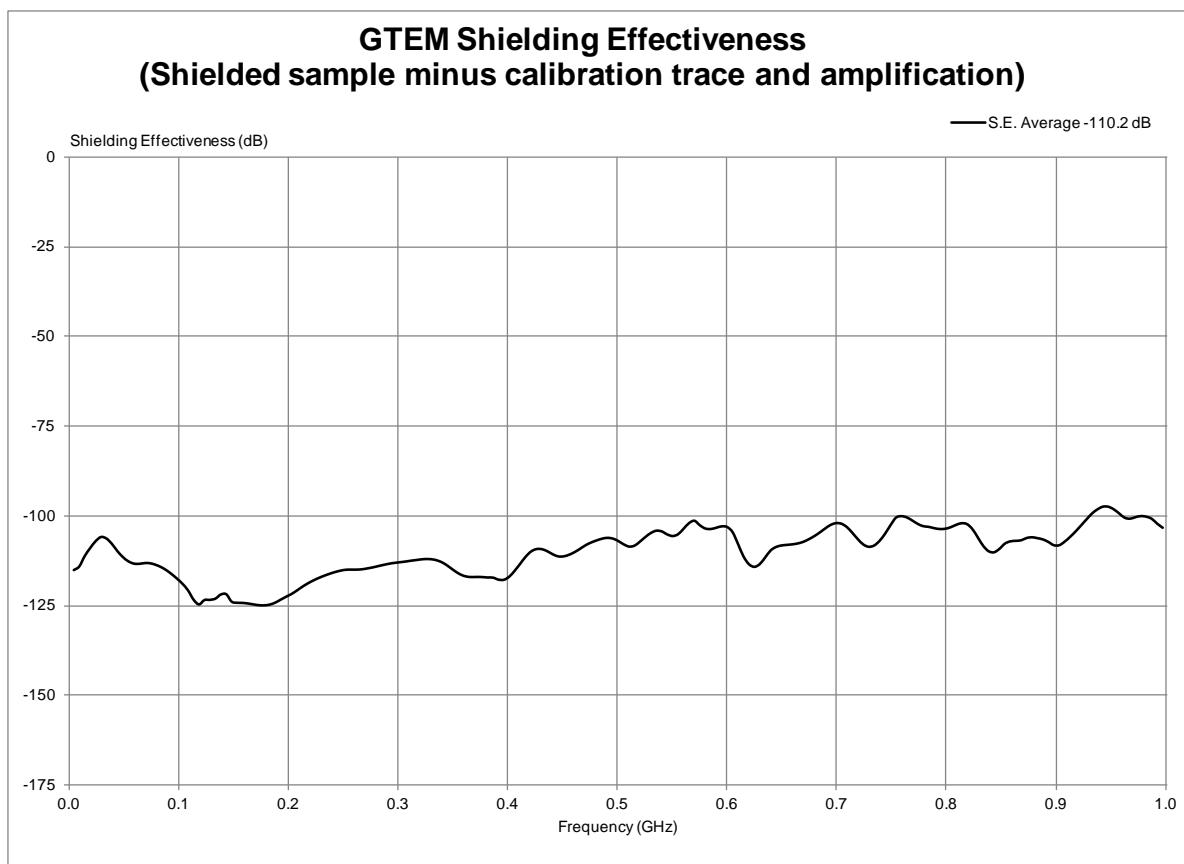

Figure 9 – Sample S.E. plot

6.6. Troubleshooting

General issues with this test are broken into test steps below. These steps assume that the system verification has been performed and there are no issues with cables and adapters.

Bare wire sweep not generating expected coupling values:

Often times the connectors at the end of the wire do not hold the center conductor as tightly as expected. Ensure the center conductor is indeed making firm contact with feed through adapter.

If leaving the preamp in the system and attenuation is placed in front of the preamp, ensure the value of attenuation is high enough that the preamp is not driven into saturation.

Verify that the bare wire is indeed within the GTEM cell uniform field. Uniform field sizes vary greatly between GTEM cells of differing sizes. In some larger GTEM cells, at the far end of the GTEM, the uniform field may start at an elevation where a 1 meter cable sample in a half loop will only “touch” the bottom of the field. Without enough length in the uniform field, very poor

coupling will result. For the purposes of this standard, a minimum length of 1ft of the sample must lie within the uniform field.

At 1ft (0.3m), a $1/4\lambda$ begins maximum coupling at 250 MHz. Since this is a comparative test, this is considered sufficient.

Users of larger GTEM cells may consider finding a smaller uniform field within the cell to make these measurements otherwise extensions may be used to lift the sample into the uniform field. Hard line cable is recommended if extensions are to be used to ensure the extensions do not cause unwanted ingress into the measurement system.

Note: Protection of the analyzer and minimum loss pad is critical at this stage. The coupling level must not reach a point where damage occurs to these components.

Dynamic range is not sufficient for measurements

Verify all connections outside the GTEM are tight. Ensure any environmental gaskets supplied with the connectors are removed. This is especially true when using 50Ω N connectors.

Verify terminator is properly seated and torque during terminator sweep, and any gaskets provided in the terminator are removed.

The use of the optional EMI box for housing all external adapters, minimum loss pad, preamp etc. may help to reduce unwanted signals from entering the measurement system.

The use of DC voltage filters on the preamp will help to ensure clean power is supplied to the preamp reducing unwanted signals.

Ensure the optional preamp has sufficient gain, especially when testing highly shielded product. A gain of 50dB minimum is recommended for measurements of highly shielded cables.

Proper maintenance of the GTEM cell is critical with respect to the EMI door seals, and any plates that have been added to the floor of the GTEM for fixturing.

Reduce the IF bandwidth, or Resolution bandwidth further on the analyzers. This will continue to lengthen the sweep time but may provide more dynamic range in the measurements.

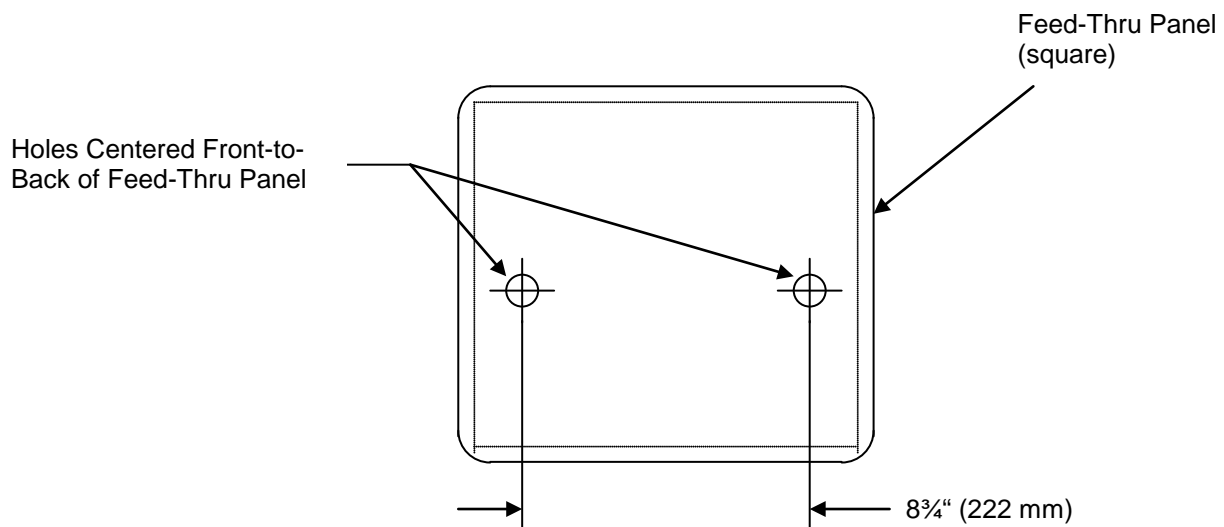

Figure 10 – GTEM feed through panel with dimensions (Dimensions will vary with GTEM size)

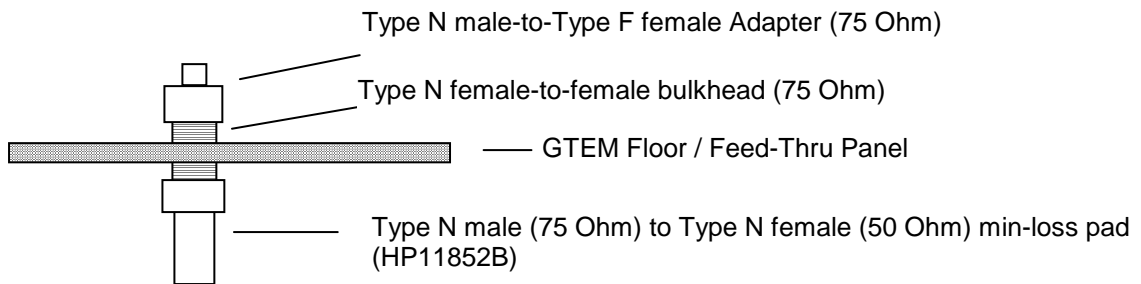
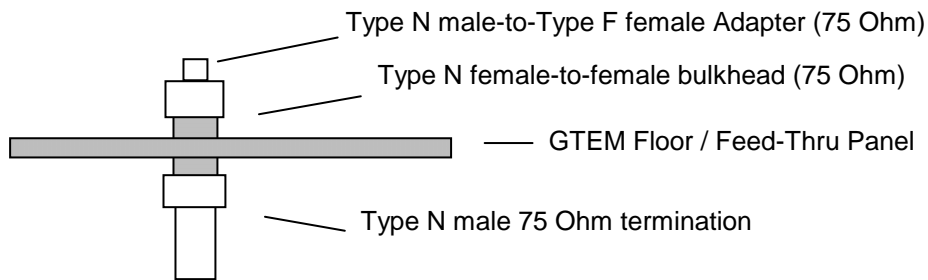
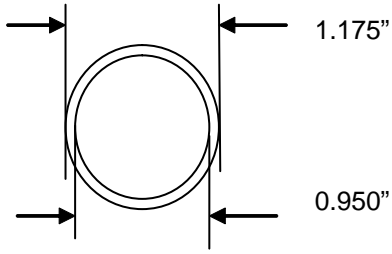

Figure 11 – a typical feed-thru adapter setup used on the GTEM floor

Top - Feed-thru panel in order to terminate a drop cable with its matching impedance.

Bottom - Feed-thru panel in order to match the 75 Ohm impedance of the cable sample under test to the 50 Ohm impedance of the test lead.



Barrel (Top View)

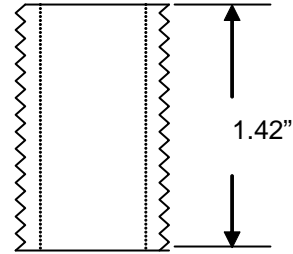

Barrel (Side View)

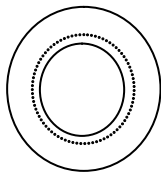

Collar (Top View)



Collar (Side View)

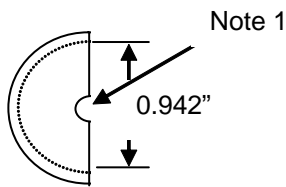

Half Sleeve (Top View)

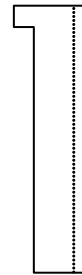

Half Sleeve (Side View)

NOTE: This opening shall be the diameter of the cable under test outer conductor OD.

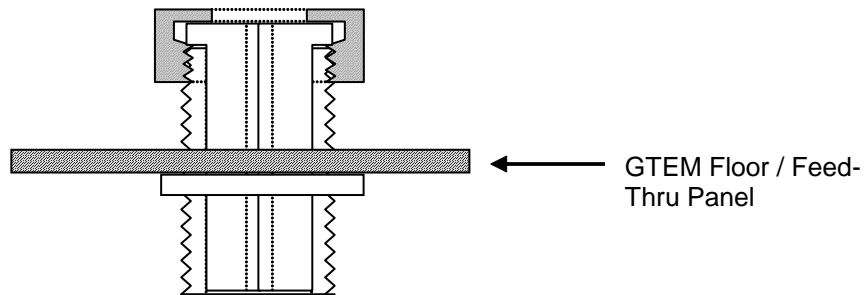

Figure 12 – Typical feed-thru configurations