



***Society of Cable
Telecommunications
Engineers***

**ENGINEERING COMMITTEE
Network Operations Subcommittee**

SCTE STANDARD

SCTE 168-6 2017

**Recommended Practice for Monitoring Multimedia
Distribution Quality**

NOTICE

The Society of Cable Telecommunications Engineers (SCTE) Standards and Operational Practices (hereafter called “documents”) are intended to serve the public interest by providing specifications, test methods and procedures that promote uniformity of product, interchangeability, best practices and ultimately the long term reliability of broadband communications facilities. These documents shall not in any way preclude any member or non-member of SCTE from manufacturing or selling products not conforming to such documents, nor shall the existence of such standards preclude their voluntary use by those other than SCTE members.

SCTE assumes no obligations or liability whatsoever to any party who may adopt the documents. Such adopting party assumes all risks associated with adoption of these documents, and accepts full responsibility for any damage and/or claims arising from the adoption of such documents.

Attention is called to the possibility that implementation of this document may require the use of subject matter covered by patent rights. By publication of this document, no position is taken with respect to the existence or validity of any patent rights in connection therewith. SCTE shall not be responsible for identifying patents for which a license may be required or for conducting inquiries into the legal validity or scope of those patents that are brought to its attention.

Patent holders who believe that they hold patents which are essential to the implementation of this document have been requested to provide information about those patents and any related licensing terms and conditions. Any such declarations made before or after publication of this document are available on the SCTE web site at <http://www.scte.org>.

All Rights Reserved

© Society of Cable Telecommunications Engineers, Inc. 2017
140 Philips Road
Exton, PA 19341

Contents

1. Scope.....	4
2. Informative References	4
3. Compliance notation	5
4. Definitions and Acronyms	6
5. Introduction.....	6
5.1. The Evolving Requirements for End to End Multimedia Management.....	6
5.2. Metrics for Quality of Service and MMM Technical Feasibility.....	10
6. Integrated and Independent Monitoring – Definitions and Recommendations	12
7. Reliability and Availability.....	12
8. Recommendations for Quality and Service Assurance Data Acquisition	13
8.1. Selecting Stream Metrics and Measurement Locations	14
8.1.1. Selecting Monitor Probe Locations at a Head End.....	15
8.1.2. Selecting Monitor Probe Locations at Hub Sites.....	17
8.2. Stream Acquisition Methods.....	21
8.3. Setting Metric Thresholds	25
8.3.1. Tracking Jitter Margin	29
8.3.2. Tracking Channel Change Times.....	29
9. Data Visualization, Reporting, and Export.....	30
10. MMM System Security Considerations.....	30
11. Recommendations List.....	31

1. Scope

The scope of this *Recommended Practice* document is to provide background and discussion on Multimedia Management (MMM) system requirements to assist the cable operator with MMM deployment design tradeoffs as well as provide guidance and recommendations on several topics related to the deployment of Multimedia Management systems based on the experiences to date of both the participating committee operators and vendor companies and the directions of ongoing work in the HMS. The topics include:

- Integrated and Independent Monitoring Strategies
- Recommendations for Quality and Service Assurance Data Acquisition
- Recommendations for Quality and Service Assurance Visualization, Reporting, and Export
- MMM System Security Considerations

This background and set of recommendations is intended to provide guidance to operators who are planning to deploy or are currently deploying MMM systems. This information is intended to be used with that provided in other HMS MMM documents.

2. Informative References

RFC 0768 User Datagram Protocol

RFC 0791 Internet Protocol

RFC 792 Internet Control Message Protocol (ICMP)

RFC 826 Ethernet Address Resolution Protocol

RFC 1112 Host extensions for IP multicasting

RFC 1349 Type of Service in the Internet Protocol

RFC 2236 Internet Group Management Protocol, Version 2

RFC 3376 Internet Group Management Protocol, Version 3

RFC 2474 Definition of the Differentiated Services Field (DS Field) in the IPv4 and IPv6 Headers

RFC 3357 One-way Loss Pattern Sample Metrics

RFC 4445 A Proposed Media Delivery Index (MDI)

ISO:

ISO/IEC 13818-1 Information technology – Generic coding of moving pictures and associated audio information: Systems (MPEG 2 Transport Streams)

CENELEC:

EN 50083-9 Cabled distribution systems for television, sound and interactive multimedia signals Part 9: Interfaces for CATV/SMATV headends and similar professional equipment for DVB/MPEG-2 transport streams (DVB ASI)

ITU:

ITU-T J.83 Series J: Transmission of Television, Sound Programme and other Multimedia Signals, Digital transmission of television signals (64-QAM, 256-QAM, 8-VSB)

ITU-T Y.1541 Series Y: Global Information Infrastructure, Internet Protocol Aspects and Next-Generation Networks, Internet protocol aspects – Quality of service and network performance (06/2006)

SCTE:

SCTE 35 2007 Digital Program Insertion Cueing Message for Cable
SCTE 142 2009 Recommended Practice for Transport Stream Verification

SMPTE:

SMPTE 2022-1-2007 Forward Error Correction for Real-Time Video/Audio Transport Over IP Networks
SMPTE 2022-2-2007 Unidirectional Transport of Constant Bit Rate MPEG-2 Transport Streams on IP Networks

DSL Forum:

Technical Report TR-126: Triple-play Services Quality of Experience (QoE) Requirements

IEEE:

IEEE 802.1Q -2005, IEEE Standard for Local and metropolitan area networks, Virtual Bridged Local Area Networks

3. Compliance notation

“SHOULD”	This word or the adjective “RECOMMENDED” means that there may exist valid reasons in particular circumstances to ignore this item, but the full implications should be understood and the case carefully weighted before choosing a different course.
“SHOULD NOT”	This phrase means that there may exist valid reasons in particular circumstances when the listed behavior is acceptable or even useful, but the full implications should be understood and the case carefully weighed before implementing any behavior described with this label.
“MAY”	This word or the adjective “OPTIONAL” means that this item is truly optional. One vendor may choose to include the item because a particular marketplace requires it or because it enhances the product, for example; another vendor may omit the same item.

4. Definitions and Acronyms

8-VSB – Acronym for 8-Level Vestigial Sideband (Digital TV RF modulation format)

DPI - Acronym for Digital Program Insertion

DTV - Acronym for Digital Television

MMM – Acronym for Multimedia Management

Mux – Multiplexer

PAT - Acronym for Program Association Table

PCR - Acronym for Program Clock Reference

PES - Acronym for Packetized Elementary Streams

PID - Acronym for Packet ID

PMT - Acronym for Program Map Table

PSI - Acronym for Program Specific Information

PTS - Acronym for Presentation Time-Stamp

QAM - Acronym for Quadrature Amplitude Modulation

QoS - Acronym for Quality of Service

RF - Acronym for Radio Frequency

SCTE - Acronym for Society of Cable Telecommunications Engineers

SI - Acronym for Service Information

TS - Acronym for Transport Stream

5. Introduction

5.1. The Evolving Requirements for End to End Multimedia Management

Operators face an increasingly competitive multimedia distribution landscape which increases the demands for operations efficiency. Successful, cost-effective, and reliable high quality delivery of thousands of media streams through dozens of network processing equipment nodes in a delivery network to hundreds of thousands to millions of subscribers requires an automated quality assurance system. The quality assurance system must correlate per-program impairment events throughout the network to provide an intelligent view of performance data to operations personnel in order to minimize maintenance expenses in detecting, locating, and repairing faults. Today's modern dynamic and growing physical IP plant deployments along with a growing subscriber base demands this to maintain an operator's competitiveness. For most deployed multimedia systems designs relying on highly compressed video streams such as MPEG 2 or MPEG 4 AVC, even a *single uncorrected IP packet loss* on a viewed stream likely results in a customer perceivable impairment.

RECOMMENDATION-1. An effective operational Quality Assurance system that continuously monitors all distributed PIDs is recommended for an operator's modern high volume media over IP network.

Stream processing devices as shown in HMS 159 are often supplied with management tools that describe the health and diagnostic results of that element. For example, the parameters described in the HMS 154 encoder MIB (& other HMS MIB examples) shows how a device is configured for stream bit rate, compression algorithm type, coding delay, enabled/disabled status, PID assignments, Port and Protocol status, Up/Down input stream status, input clock sync, input/output amplitude levels. However, per-PID compliance monitoring employing information such as described by SCTE 142 Transport Stream Verification and flow monitoring such as described in RFC 4445 is not usually included – that is, it has been too costly and complex for every processor device to incorporate per PID analysis (Transport Stream Verification) for all PIDS processed.

Yet, to keep costs in check, an operator must know immediately *if* transient PID issues occur, must know *where* they occur, and must have network visualization tools that allow *correlating* issues for fault isolation and for cost effective troubleshooting dispatch. Without such tools, the operations staff is reduced to best guesses, random interconnect and device replacement, switch/router configuration and tuning with no way to measure results. Quick problem resolution and root cause analysis using these measurement and analysis methods allows the operator to improve customer satisfaction and reduce churn.

Multimedia over IP Considerations – For most deployed systems to date

Most deployed digital media systems to date by operators have employed media over IP networks for major portions of the infrastructure and use ISO 13818-1 MPEG Transport Streams over UDP/IP, with Ethernet protocols. An example of MPEG over UDP/IP protocol analysis is shown in Figure 1 below.

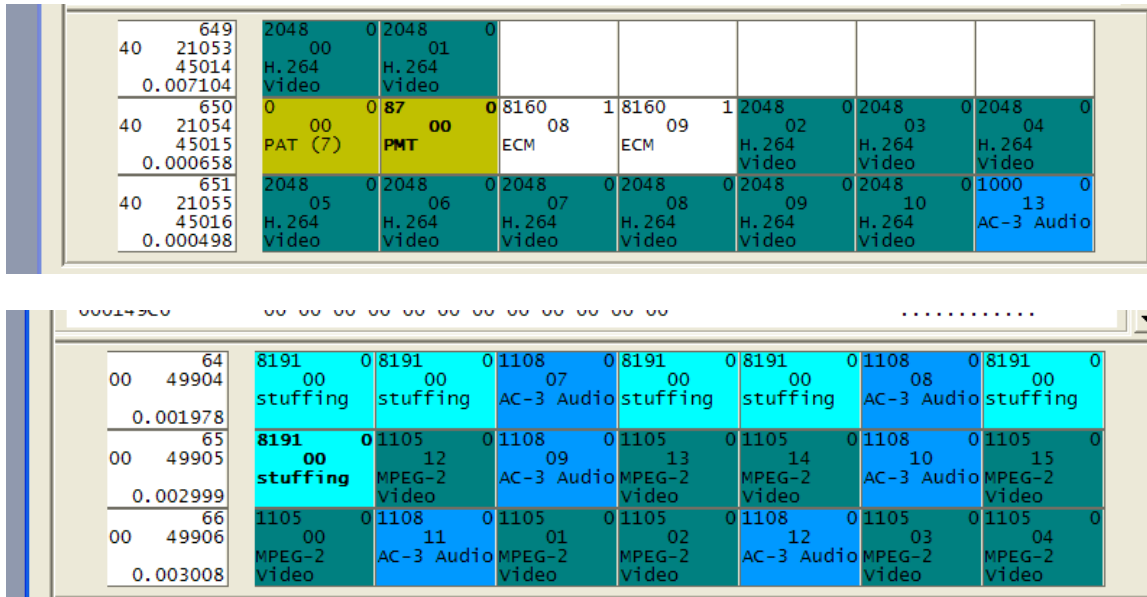

Figure 1: Media over IP protocol analysis view from the IQTsX tool

In Figure 1, each colored horizontal line of boxes represent a single IP packet with each box representing a single MPEG Transport Stream packet. The uncolored boxes to the far left shows statistics on the IP packet to its right including, from top to bottom, the ordinal number of the packet in the analyzed file, the RTP payload type and the RTP sequence number (if RTP is used), and the elapsed time since the previous packet was received in seconds. Within each TS packet box, a number of parameters are shown including the PID number to which the packet belongs, the Continuity Counter value, the type of data in the packet, etc.

It can be seen in these few packet captures that the type of data in any given IP packet varies widely. For example, in the first IP packet of the 2nd capture, there are no video packets at all – only MPEG-2 NULL packets (labeled as stuffing) and audio where in the last IP packet of the 1st capture, there are 6 video packets and 1 audio packet. From the above analysis it can be seen that the effects of a single lost IP packet will vary but will nearly always carry some video since video is, by far, the highest bit rate content and thus occurs most often in the stream. Of course some video packets impact the picture quality more than others and that impact is dependent on the type of pictures and the type of program being carried at that instant.

Since most deployed networks do not prioritize specific packets based on content¹ or handle packets with different content differently, and since any IP packet is expected to carry any mix of video, audio, or control information (PSI/SI tables), a single packet loss might affect video, audio, or the ability of a decoder to make sense of the data being received. ***That makes every IP packet important*** as even if one or another type of information corruption might be deemed acceptable with low frequency, the current

¹ Note that protocol type is typically prioritized in many complex MSO provider networks specifically addressing congestion avoidance and resource allocation during network outages but a given video stream’s packets with different content are not prioritized.

popular protocols prevent the network from handling one type of information differently from another since each type of information can be mixed within the same IP packet.

With every packet loss carrying the likelihood for audio and/or video corruption, it is obvious and critical that an operator be able to detect all packet losses on all flows throughout the network and be able to determine when and where such losses occur for quality assessment and fault isolation maintenance. An acceptable IP packet loss magnitude and frequency can be directly related then to how often and how severe subscriber impacts are expected to be tolerated. Some reasonable assessments have recently been published by the DSL Forum in TR-126 based partially on previous work by CableLabs (*see section 4.3 for more details on setting acceptable metric thresholds for the cable environment*):

Compression Type	Resolution (bitrate)	Max Error Frequency	Max # IP Packets Per single Error
MPEG 2	SD	1 per Hour	7 IP packets
MPEG 2	HD	1 per 4 Hours	27 IP packets
MPEG 4 AVC/VC1	SD	1 per Hour	5 IP packets
MPEG 4 AVC/VC1	HD	1 per 4 Hours	17 IP packets

DSL Forum Recommended Minimum Transport Layer Performance Parameters for Satisfactory QoE for MPEG-2/MPEG-4 encoded SD/HD TV Services (TR-126)

With the growing features and complexity of provider network delivery systems that now include VoD, simulcast, Digital Program Insertion (DPI), Switched Digital Video (SDV), along with VoIP and High Speed Data (HSD), maintaining these quality standards is nearly impossible without a continuous improvement feedback system. One method available is a system that continuously measures per-PID quality as determined by selected metrics and can provide trend information to confirm that investments and improvements are yielding the expected results. When impairments do occur, such a system of measurements available across the transport network is needed to be able to locate the source of impairments for corrective action quickly and accurately.

Multimedia over IP Considerations – For some emerging technologies

There is a growing consideration in Digital Video networks to include Forward Error Correction (FEC) and/or ARQ protocols in network segments carrying video to improve the effective packet error rates. Both these methodologies use additional network bandwidth to correct for packet loss either by reconstructing the missing packet(s) from a repair stream (FEC) or through retransmission of the missing packet(s) upon demand from a receiver (ARQ). These mechanisms may change the recommended target values mentioned above. These mechanisms are not currently common in cable operator networks. Both mechanisms also introduce additional latency in program delivery times.

5.2. Metrics for Quality of Service and MMM Technical Feasibility

Experience over several years of operating plants with digital streaming media over IP networks has shown that many types of faults are transient in nature and difficult to localize and troubleshoot with traditional techniques. Today’s methodologies include, for instance, a technician directly viewing and listening to one or more programs or using one-time measurement tools and video monitors. This document, on the other hand, identifies monitoring practices that **automatically** examine program flows **continuously** and at multiple locations in the transport network simultaneously to facilitate the identification and location of both transient and persistent impairments. Through the judicious selection and use of optimal metrics at optimal locations, cost and complexity of this approach is kept reasonable and makes this approach feasible.

RECOMMENDATION-2. To provide a cost effective solution for Multimedia Management and monitoring it is recommended that continuous program monitoring at multiple simultaneous strategic locations be deployed to make possible traditional “divide and conquer” troubleshooting for transient streaming media impairments.

- For example, if a program is continuously monitored at the Head End (metro, regional, or national), within the IP transport network, and at a Hub site as it enters the HFC network, any transient impairment can be detected whenever and wherever it occurs.
- By examining the timestamps of logged impairments at each of the monitoring locations, it is possible to determine the most upstream location of the impairment -- the impairment origin -- for purposes of assigning the correct technical resources to the correct location for detailed troubleshooting.
- The resolution, or ability of this approach to locate a particular fault location, depends on how many distribution system demarcations are simultaneously monitored. While more locations will expedite locating a fault, this will require more capital investment.

This document makes recommendations on key demarcations that ***should*** be continuously monitored to locate a fault to a building location and includes ***minimum recommendations*** for configurations and systems where capital investment is particularly constrained.

Figure 2 illustrates a simplified end-to-end monitoring system with demarcation examples at the Head End, IP Transport cloud, Hub Site, and HFC network. The vertical bars indicate stream monitoring locations while the dotted vertical lines show Head End, IP core, and Hub site demarcations. By continuously monitoring each program simultaneously at multiple downstream locations, an impairment can quickly be detected and its location determined. By selecting the appropriate metrics at each location, cost and complexity can be minimized.

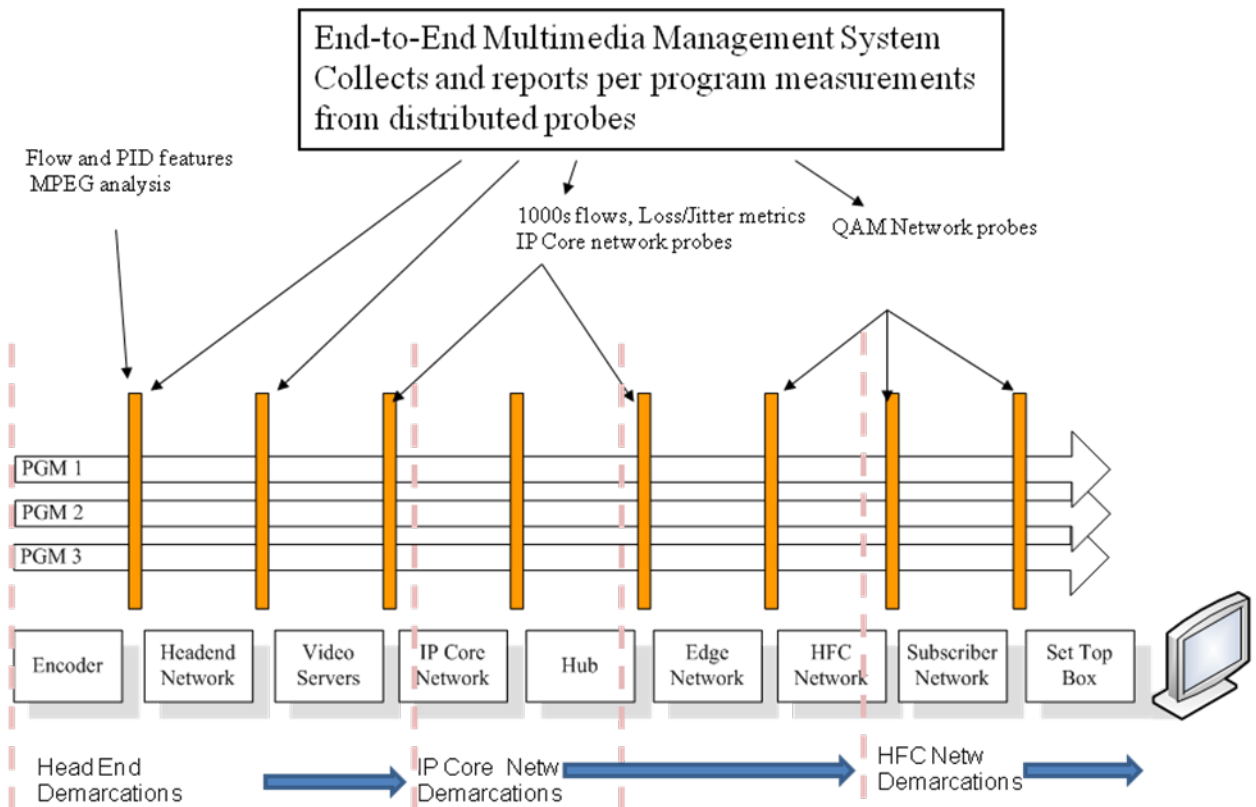

Figure 2: Distributed Simultaneous Program Monitoring

RECOMMENDATION-3. *To provide a cost effective solution for Multimedia Management and monitoring it is recommended that the particular set of parameters that might have been affected since the previous upstream monitoring location be measured and correlated. Supplementary metrics may also be necessary to gain sufficient information about an issue for precise fault location and repair.*

That is, if there are two measurement locations deployed, say at the input to a layer 2/ switch/router and at the output of a switch/router, the stream parameters of interest to measure are packet loss and jitter; namely, the stream parameters that can be affected by the device(s) between the measurement points. It would be redundant and unnecessary to measure the SCTE 142 Transport Stream Verification parameters since the payload is not modified by the switch/router. Likewise, if, for example, the two measurement points are widely separated across the distribution network at, say, the MPEG Encoder in the Head End and the QAM Modulator at a Hub Site, and devices such as multiplexers, rate shapers, DPI devices, etc. that do modify the Transport Stream are intervening, then all protocol encapsulation layers including SCTE 142 and IP metrics should be monitored

though repeated content analysis is not required. For more details on which metrics to measure and where they should be measured, see other documents from the MMM series.

Note that there are a number of variables which may affect a subscriber's perception of MSO delivered quality such as the subscriber's own TV, viewing environment, program content, program ordering experience, etc. These are out of scope for this HMS MMM document.

Note also that this strategy for problem detection and localization works in many situations, supplementary monitoring metrics may also be needed to gain sufficient information about an issue for precise location and repair.

6. Integrated and Independent Monitoring – Definitions and Recommendations

Most modern digital multimedia monitoring strategies employ both *integrated* and *independent* quality and service assurance systems. An *integrated* monitoring system is one that is a component part of a service-providing equipment system such as the monitoring provided internally by an IP switch/router or group of switch/routers and their management system (Element Management System (EMS), a VoD server and its accompanying management system, a QAM modulator or group of QAM modulators and their accompanying management system, etc. An *independent, or dedicated* monitoring system is a component or system that is generally separate from service-providing equipment and is typically dedicated to quality, service assurance, and troubleshooting missions. An example of an independent monitoring system is a probe or analyzer used to measure a stream, possibly alarm if the measurement exceeds an acceptable value, possibly trigger and capture a fault condition for purposes of further analysis and troubleshooting, etc.

Both independent and integrated monitoring systems are often provided as a complete system with distributed measuring devices separate from the user's GUI platform. Both types can offer facilities to export measurement results through a Northbound interface (typically SNMP or XML based). When the export facilities are defined as standard MIBs that a standardized OSS/BSS management platform interacts with, the communication protocols are likewise often standardized.

7. Reliability and Availability

The growing trend by providers toward deploying system redundancy to achieve high service availability should apply to quality and service assurance systems as well.

RECOMMENDATION-4. It is recommended that for redundant service network-based components such as two switch/routers, each interfacing to a redundant core transport system (1+1 protected) and redundant downstream distribution system, the

monitoring system should likewise be redundant and be connected such that monitoring can be sustained in the event of any single failure or during scheduled maintenance.

This includes monitoring at both the primary and secondary path as shown in Figure 3.

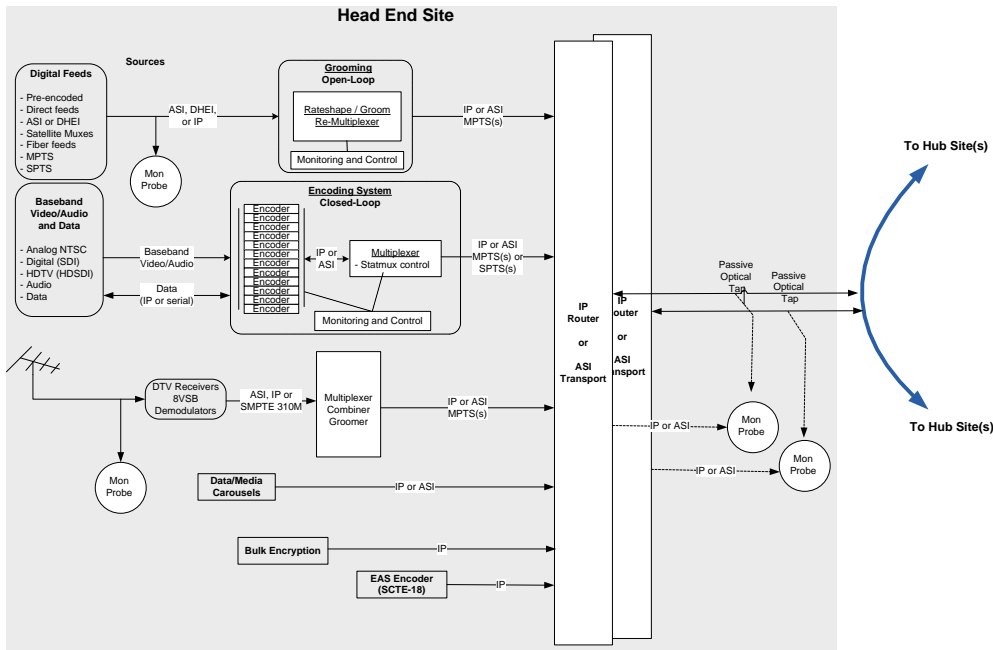

Figure 3: Redundant Connection to Core Transport System with Monitoring

RECOMMENDATION-5. *It is recommended that the monitoring equipment be powered with the same strategy as the local service providing equipment such as DC power, UPS backed AC, etc.*

8. Recommendations for Quality and Service Assurance Data Acquisition

Per the HMS 159 diagram below, the modern cable plant employs a number of stream processing components in a head end to STB flow such as the MPEG encoder, Multiplexer, Groomer, Ad Splicer, Bulk-Encryptor, SDV-servers, QAM modulators, and STB as well as IP and RF distribution as shown in the example below. Each processor, interconnection, and distribution system can potentially introduce faults which are then propagated downstream to the subscriber. Managing such a complex delivery system is greatly facilitated by providing system performance information on each processor and interconnection system giving the operator observability to detect and locate faults when they occur.

- Video and audio are typically compressed and encapsulated for ingest into the IP transport system. These functions may be part of a headend ingest facility, a Video on Demand server farm, a contribution feed or a local ad insertion site. Other media source locations can also be envisioned.
- Multiple video/audio sources such as off-air encoders, video servers, etc. are aggregated at an edge switch or router. This stage typically results in a multi-stream aggregate data flow available for forwarding downstream over a geographic region for redundancy and connectivity.
- One or more edge devices then forward streams to individual stream consumers via edge equipment such as but not limited to QAM modulators, or DOCSIS-based QAM delivery, and FT Tx technology. In some cases the edge switch/routers may directly forward streams to the stream consumers via Ethernet or other layer 2 protocols.

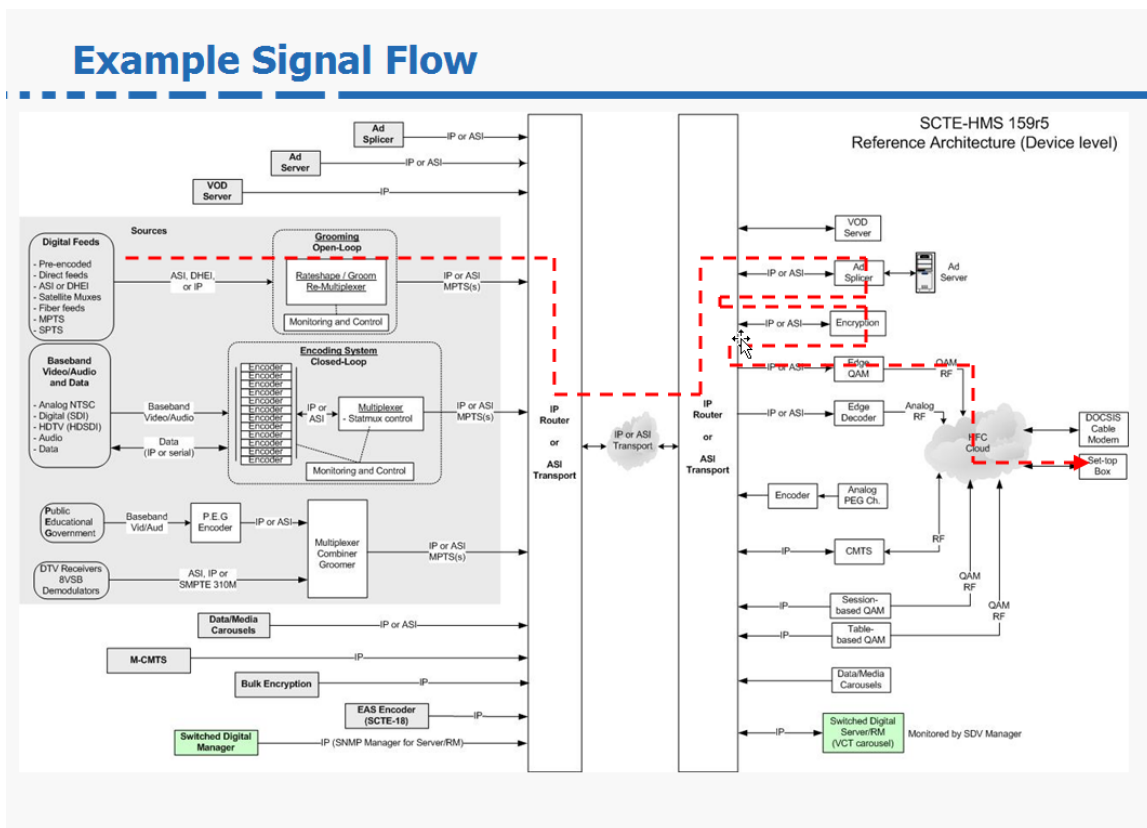

8.1. Selecting Stream Metrics and Measurement Locations

RECOMMENDATION-6. *It is recommended that, at least sufficient continuous program monitoring and measurement locations be deployed to make possible impairment isolation to a facility location. More monitoring locations can optionally be deployed to locate an impairment to a particular delivery subsystem.*

By providing sufficient stream measurement locations on its end-to-end path, it is possible to detect and locate impairments introduced by the various processors whether or not the processor's self diagnostics detect an impairment. Choosing the number of measurement locations is a tradeoff exercise involving location resolution vs. cost. By adding more live locations, a fault can be located more quickly and with more resolution using the traditional troubleshooting technique of "divide and conquer." For an extreme example, with every processing device monitored at both its input and output, it can be determined that if a stream has no impairments entering a processor element and has impairments leaving the processor element, then the fault is located to that piece of equipment. It is recommended that, at least, sufficient measurement locations be deployed to identify an impairment to a building location such as a head end, hub site, distribution node, etc. This can be accomplished by deploying monitoring equipment at the outputs of each physical location. Examples are shown in the sections below.

8.1.1. Selecting Monitor Probe Locations at a Head End

The primary objectives of deploying monitoring technology at the Head End is to detect faults and determine whether the fault originated within the Head End site to facilitate troubleshooting. Programs transmitted from a Head End are of particularly high value as they most often feed multiple downstream hub sites and impairments therefore affect more subscribers than downstream distribution sites. Thus it is particularly important that impairments originating at this location be quickly detected and repaired.

RECOMMENDATION-7. Because of the programs' high value at the egress from a Head End, it is recommended that all transmitted programs be continuously monitored close to the outputs of the site. Head End monitoring should include metrics specified in SCTE-142.

As shown in Figure 4 and described above, stream access can be accomplished with a passive optical tap or switch/router SPAN or Mirror port. The monitor(s) should have adequate stream capacity to accomplish the continuous monitoring (all transmitted packets) of all programs for all the recommended metrics in this document series. .

For Head End sites using a star interconnect architecture where multiple Hub sites are directly fed with separate dedicated links from the Head End, it may be desirable to utilize one or a small number of monitor probes connected to the Head End's output router(s) via SPAN/Mirror port(s) rather than a larger number of individual Passive Optical Taps.

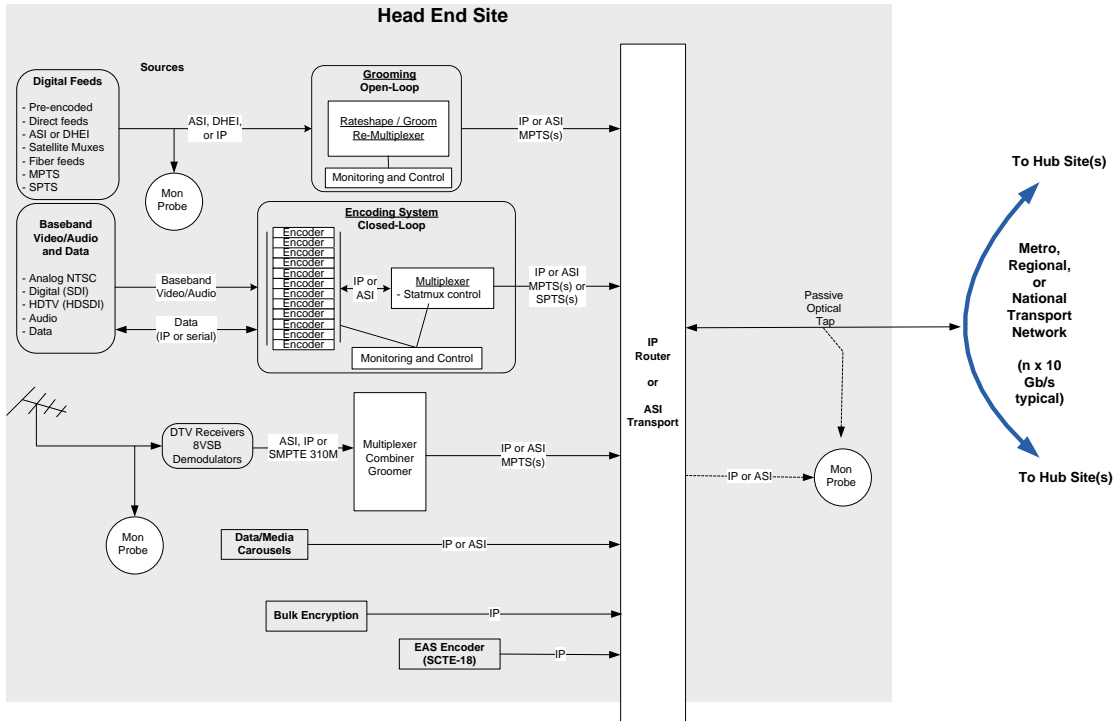

Figure 4: Example Head End Site

RECOMMENDATION-8. *It is recommended that all program inputs to the Head End Site be continuously monitored including both digital and off-air feeds.*

Combined with egress monitoring, this will provide sufficient information to determine if Head End assets caused an impairment or the program as received was impaired – rapid fault isolation requires both monitoring locations for all programs.

To assure program availability to the rest of the network, the Hub Site is often connected to downstream locations via redundant paths. These multiple paths may continuously share the traffic loads or be configured in a Primary/Backup configuration.

RECOMMENDATION-9. *For redundant connections to downstream locations, it is recommended that all redundant paths be continuously monitored.*

If configured to share the traffic loads then all paths will need to be monitored to satisfy the requirement for continuous program monitoring. If configured for Primary/Backup connections then continuous monitoring of the backup path is recommended to assure that the backup path is error free if needed due to a failure of the primary path.

RECOMMENDATION-10. *If the recommended monitoring points are not possible at a Head End location for financial or other available resource constraints, the minimum recommended configuration is continuous program monitoring at the primary egress.*

8.1.2. Selecting Monitor Probe Locations at Hub Sites

The primary objectives of deploying monitoring technology at a Hub site is to detect faults and determine whether the fault originated within that Hub site in order to facilitate troubleshooting. While Hub sites typically do not transmit to as many downstream locations as a Head End they do typically serve many nodes and thus many subscribers also making the programs at Hub sites high value. Since the egress technology is typically HFC and requires a tuner to detect and monitor an RF channel, the recommendation at this point in the network is for the monitor to scan the transmitted channels. It is recommended that all transmitted channels be monitored within the HFC network at the output node(s) of the hub site such that all programs are examined within a maximum delay of 15 minutes. Note that visualization tools (remote) can also be used here that allow the technician to view the real time stream quality. Access to the HFC network is available via a node's combining network.

RECOMMENDATION-11. The monitor(s) should have adequate stream capacity to accomplish the monitoring of all programs for all the metrics recommended by the this document series with a frequency of at least every 15 minutes.

RECOMMENDATION-12. The monitor(s) should have the ability to archive the data to network-based storage repositories allowing historical trending of the traffic.

RECOMMENDATION-13. The monitors should have a time synchronization capability such as Network Time Protocol (NTP) or other means to assure that all measurement locations can successfully timestamp monitored events such that all measurement points within a network maintain a local reference clock which matches all other local reference clocks within 1 second. This facilitates correlating measurements at different locations in the network.

Hub sites often include significant and complex stream processing equipment. It should be noted that it can be advantageous to monitor all programs at additional locations within a Hub Site beyond those recommended in each section below in order to be able to identify an impairment location with greater precision (as discussed in section 1.3) if capital resources permit. This is facilitated by common modern architectures where programs enter the same switch/router repeatedly as they are being encrypted, Ad spliced, rate shaped, multiplexed, etc. A given program both pre and post ad spliced is readily accessible by a monitor from a single connection point for example.

8.1.2.1. Selecting Monitor Probe Locations at Hub Sites with Unidirectional Program Flows and a Single Node Group

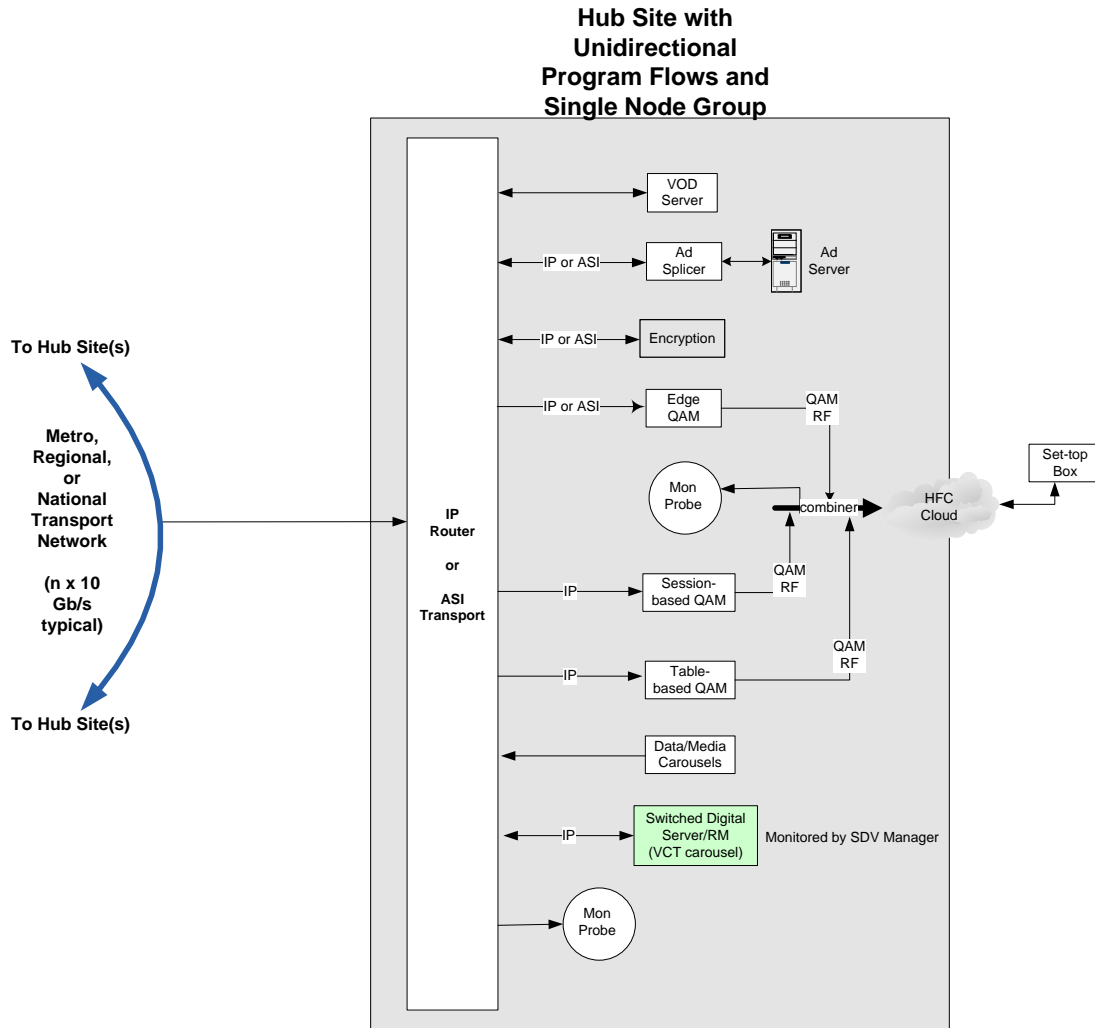

Figure 5: Example Hub Site with Unidirectional Program Flows and Single Node Group

As shown in Figure 5, the Hub site in this section only receives programs from the regional or national transport network (unidirectional program flow) and does not originate programs for transmission to this network. This type of Hub site may have media processing devices such as Digital Program Insertion splicers, VoD servers, encryption devices, QAM Modulators, SDV assets, etc.

RECOMMENDATION-14. *It is recommended that all ingress programs at a Hub site from the regional transport network be continuously monitored using one of the recommended methods for stream access.*

RECOMMENDATION-15. *For Hub site configurations with redundant connections to a metro, regional or national transport network, it is recommended that both ingress paths be continuously monitored.*

RECOMMENDATION-16. *If the recommended monitoring points are not possible at a Hub site for financial or other available resource constraints, the minimum*

recommended configuration is continuous program monitoring at the primary egress (typically the HFC network.) For the HFC egress, it is recommended for the monitor to scan the transmitted channels. It is recommended that all transmitted channels be monitored within the HFC network at the output node(s) of the hub site such that all channels are examined within a maximum delay of 15 minutes.

8.1.2.2. Selecting Monitor Probe Locations at Hub Sites with Bidirectional Program Flows and a Single Node Group

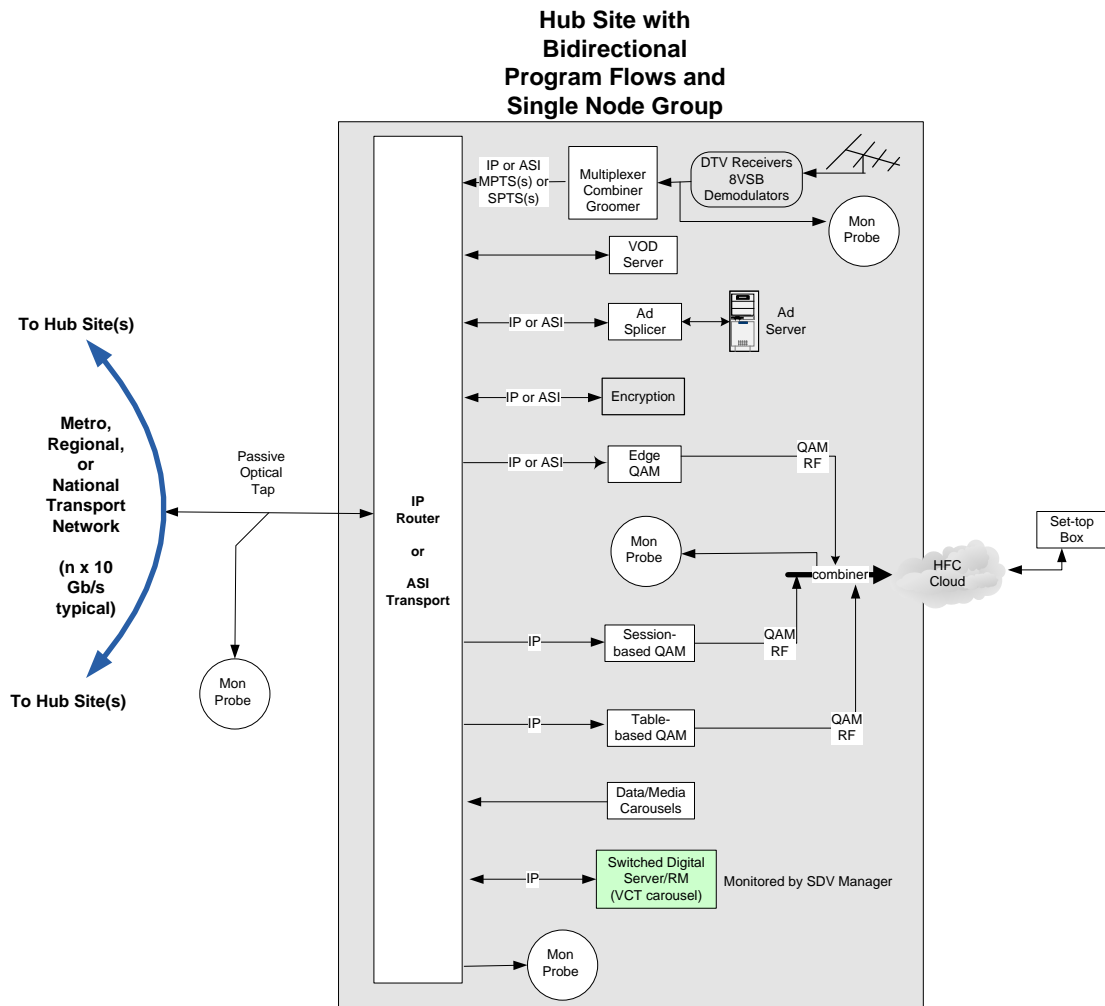

Figure 6: Example Hub Site with Bidirectional Program Flows and Single Node Group

As shown in Figure 6, the Hub site in this section both receives programs from the regional or national transport network and originates and forwards programs to the same transport network for distribution (bidirectional program flow). An example of such programs would be local off-air channels received at this site and forwarded to other Hub sites and/or VoD programs. This type of Hub site may have media processing devices

such as Digital Program Insertion splicers, VoD servers, encryption devices, QAM Modulators, SDV assets, etc.

RECOMMENDATION-17. For Hub sites that both receive from and originate programs to a Metro, Regional, or National transport network, it is recommended that all ingress programs from the transport network be continuously monitored using one of the recommended methods for stream access. For configurations with redundant connections to a regional or national transport network, it is recommended that both ingress paths be continuously monitored. It is also recommended that all transmitted programs to the transport network be continuously monitored. For the HFC egress, it is recommended for the monitor to scan the transmitted channels. It is recommended that all transmitted channels be monitored within the HFC network at the output node(s) of the hub site such that all channels are examined within a maximum delay of 15 minutes. These recommendations are also the minimum recommended monitoring configurations.

8.1.2.3. Selecting Monitor Probe Locations at Hub Sites with Bidirectional Program Flows and Multiple Node Groups

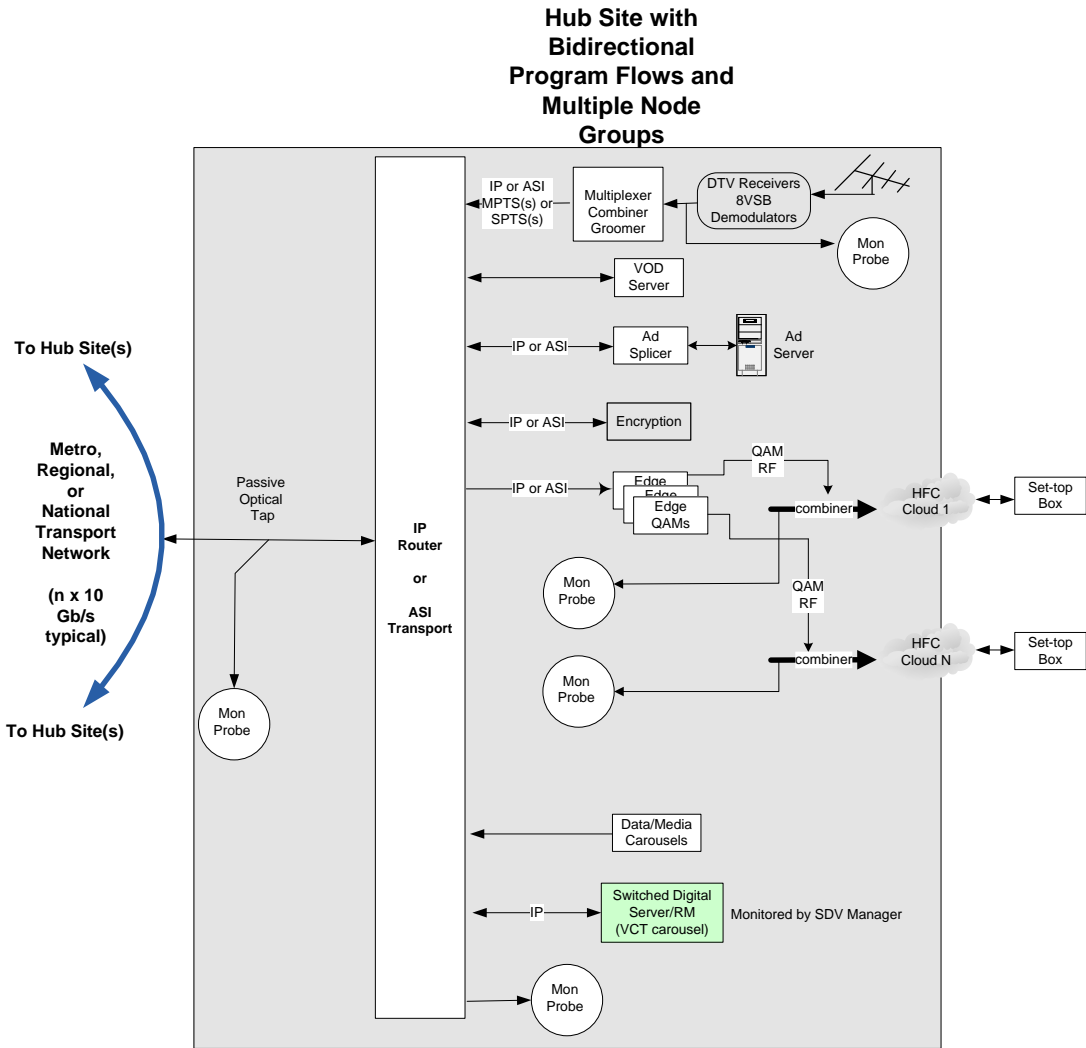

Figure 7: Example Hub Site with Bidirectional Program Flows and Multiple Node Groups

As shown in Figure 7, the Hub site in this section both receives programs from the regional or national transport network and originates and forwards programs to the same transport network for distribution (bidirectional program flow). An example of such programs would be local off-air channels received at this site and forwarded to other Hub sites and/or VoD programs. This type of Hub site may have media processing devices such as Digital Program Insertion splicers, VoD servers, encryption devices, QAM Modulators, SDV assets, etc. Since this Hub site feeds multiple downstream nodes typically consisting of separate ad zones, separate monitors for each node may be required.

Recommendation #17 described above applies for this Hub site configuration also.

8.2. Stream Acquisition Methods

For ***integrated*** measurement systems, gaining access to streams for monitoring purposes is straightforward since the streams are already being processed within that equipment. No additional considerations are necessary for acquiring these streams for MMM. Equipment such as encoders, multiplexers, ad inserter, switches, and routers are some examples of gear with the potential for integrating the monitoring measurements needed for MMM.

RECOMMENDATION-18. For independent monitoring systems, the recommended methods for directing streams to a probe for monitoring and troubleshooting purposes include: Switch/Router SPAN/Mirror Port(s), Passive Optical Splitter, or Active IGMP Join of Multicast flows.

OPTION 1: USING A SPAN/MIRROR PORT TO MIRROR LIVE TRAFFIC

Many switch and router products provide an option to copy or SPAN the traffic appearing on a port to a selected output port on command. This feature can be used to make available a set of traffic flows to monitoring equipment if a switch/router port is available. This approach, like the Optical Splitter covered in Option 2, does not adversely affect the performance or reliability of the network and can be reconfigured as needed on demand for troubleshooting should the need arise. Reconfiguration would support routing streams sequentially from any number of switch input ports to a probe. Often there are limits as to the number of SPAN sessions that may be configured simultaneously per switch. This means that the number of probes that can be used per switch when using the SPAN port access methodology will depend on the number of SPAN sessions the switch/router can simultaneously support.

SPAN Overview

SPAN mirrors traffic from one or more source interfaces on any VLAN or L3 port, or from one or more VLANs to a destination interface for analysis. In figure 7, all traffic on Ethernet interface 5 (the source interface) is mirrored to Ethernet interface 10. A probe on Ethernet port 10 receives all network traffic from Ethernet port 5 without being physically attached to it.

For SPAN configuration, the source and destination interfaces must be on the same switch.

Overview of SPAN

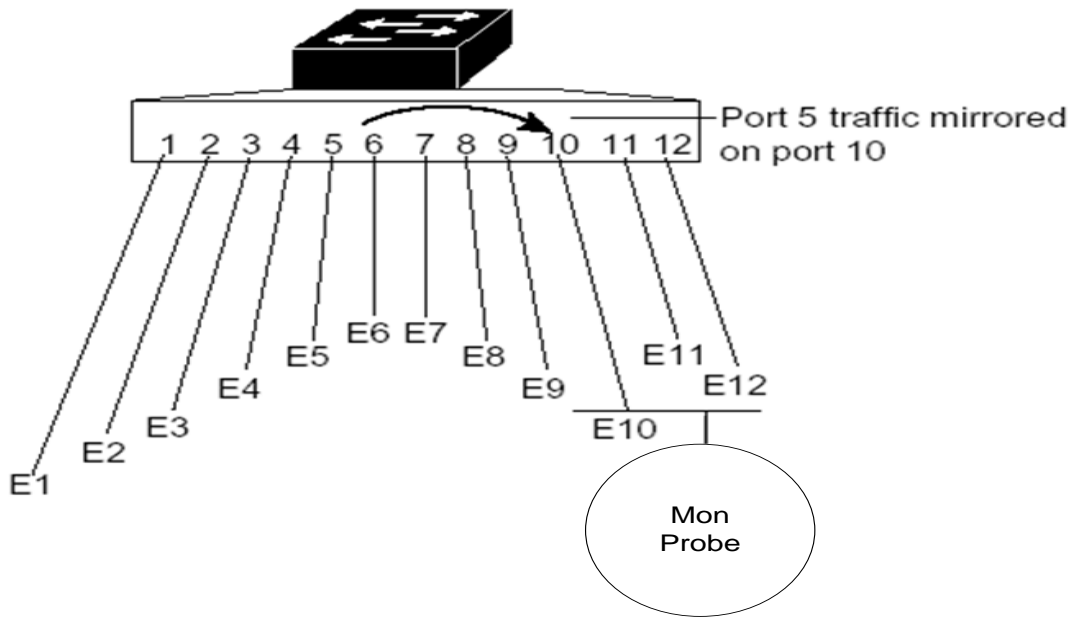

Figure 8 Example of SPAN Configuration

SPAN configuration guidelines and considerations

Follow these guidelines and considerations when configuring SPAN:

- Use a probe to monitor interfaces.
- Consider the limits of a selected switch/router with respect to VLANs within a SPAN session.
- Consider the limits of trunk interfaces such as 802.3ad with respect to a SPAN session. Trunk interfaces sometimes cannot be SPAN source and/or destination interfaces.
- Consider whether it is desired to specify a type of traffic from a source interface such as Transmit only, Receive only, or both.
- Consider bandwidth and VLAN limits of destination ports if specifying multiple SPAN source interfaces for a single destination port.
- Consider that a SPAN destination interface usually does not receive ingress traffic.
- Consider that SPAN destination ports do not participate in any spanning tree instance. SPAN destination may include BPDUs in the monitored traffic, so any BPDUs seen on the SPAN destination are from the SPAN source.

Configuring a SPAN source

To configure the source for a SPAN/Mirror session, consult the switch/router manufacturer's directions.

OPTION 2: OPTICAL SPLITTER

If the network infrastructure components are connected using optical fibers, passive optical splitters can be inserted at strategic network locations such as at the output of servers, the inputs and outputs of key switch/router components, and at high-speed uplink aggregation points. Such passive splitters are available for both multimode and single mode fiber with various network and tap attenuations. Since they are passive and economical, they may be inserted without much concern that they will adversely affect the performance or reliability of the network and they may be left in place for ready access to paths should the need for troubleshooting arise. The tap ports can then be connected to test equipment for flow analysis continuously or on an as-needed basis.

OPTION 3: ACTIVE TAP

Probes can often be configured as an active Ethernet network tap device. This means that its two ports are inserted in an active link to analyze flows with a minimum of disturbance to the flows. Note that the probe must remain powered and in an active tap mode to prevent interruption of the connected link and thus is NOT recommended for live operational networks but is better suited for installing and commissioning new network segments and for laboratory use.

Option 4: Multicast

While the above options allow probes to transparently monitor and analyze streams, probe devices also can participate as multicast clients on a multicast network. A probe can be configured to actively join and leave single or multiple multicast flows via IGMP. This allows the probe to join and analyze multicast streams with no reconfiguration of the switch SPAN port features. Use of this access method also permits monitoring and logging the network’s channel change times.

Routers may also be configured to simply add a static join to the interface thus assuring the delivery of a stream or group of streams to a probe for stream monitoring though this method prevents exercising and measuring IGMP performance.

RECOMMENDATION-19. For monitoring unicast VOD or other types of traffic, an optical splitter or SPAN/Mirror port is recommended for use in production networks.

RECOMMENDATION-20. When using SPAN /Mirror Port(s), it is recommended that the health of the switch/router (CPU, memory usage, etc.) be actively managed as well to help assure that the switch/router normal forwarding operation is unaffected by the use of the SPAN/Mirror port .

Option Summary

Choice of the above alternatives depends on the type of system interconnect, the type of traffic being monitored, and switch port availability. For maximum flexibility of access

to any stream within a switch node, the SPAN port option is recommended. By simply reconfiguring the SPAN port, any flow or group of flows can be directed to one or more probes. When a port is not available for SPAN configuration, the optical tap option provides access to all types of streams on the port without disturbing system operation.

8.3. Setting Metric Thresholds

RECOMMENDATION-21. It is recommended that for MPEG metrics described in SCTE 142 2007 (“Recommended Practice for Transport Stream Verification”), the thresholds for performance described in that document should be consulted.

For network loss and jitter acceptable thresholds, see TR-126 for discussion of how these are derived. Per TR-126,

“Ideally the maximum loss period [duration] would correspond to one IP packet since even a single lost packet can result in a very noticeable impairment as shown in Figure 11 [ed: see TR-126 for this figure]. However, to account for possible use in a xDSL environment, including loop impairment behavior and FEC techniques available at the xDSL physical layer (RS, interleaving), we consider a loss period greater than a single packet.”

Given that cable operators employ HFC for subscriber interconnects, this greater IP loss duration does not apply. To meet the Loss Distance criteria of 1 error event per hour for SD or 1 error event per 4 hours for HD, an operator should use single uncorrectable packet loss events as the criteria for the definition of an “error event” in the TR-126 tables.

Also from TR-126:

“Network latency and jitter should be engineered to closely align with set top box jitter buffer provisioning (wait time and buffer size) and overall network design and therefore may vary from implementation to implementation. Typical set-top box de-jitter buffers can store 100-500 ms (of SDTV) video, so network jitter must be within these limits and delay variation beyond these limits will manifest itself as loss. Increasing buffering also negatively impacts channel change latency so ideally the de-jitter buffers should be set as small as possible. Objectives outlined for jitter are based on experiences of operators and STB buffering capabilities.”

As described above, required end-to-end per-flow jitter performance depends on both receiving device de-jitter buffer size and network topology and network device queuing capabilities. For cable operators using HFC for subscriber interconnects, the IP de-jitter buffer resides within the Edge QAM rather than the STB. The recommended jitter maximum should be considered as a guide and will depend on the particular network devices utilized and their queuing configuration and capabilities. Ideally, such choices should be stress tested before deployment to determine actual maximum jitter tolerances.

Note that a transient excursion beyond a system’s maximum jitter tolerance will result in packet loss. Note too that the jitter of all source devices such as encoders, video servers, encryptors, muxes, etc. must be considered in the end-to-end transport design. Refer also to ITU Y.1541 and RFC 4445 for a further discussion of jitter (also known as IP Delay Variation) and its causes and measurement.

The following four tables are the guidance provided by TR-126:

Transport Stream bit rate (Mbps)	Latency	Jitter	Max duration of a single error	Corresponding Loss Period in IP Packets	Loss Distance	Corresponding Average IP Video Stream Packet Loss Rate
3.0	<200 ms	<50 ms	<=16 ms	6 IP packets	1 error event per hour	<=5.85E-06
3.75	<200 ms	<50 ms	<= 16 ms	7 IP packets	1 error event per hour	<= 5.46E-06
5.0	<200 ms	<50 ms	<=16 ms	9 IP packets	1 error event per hour	<=5.26E-06

Recommended Minimum Transport Layer Parameters for Satisfactory QoE for MPEG-2 encoded SDTV Services (TR-126 Table 12)

Transport Stream bit rate (Mbps)	Latency	Jitter	Max duration of a single error	Corresponding Loss Period in IP Packets	Loss Distance	Corresponding Average IP Video Stream Packet Loss Rate
1.75	<200 ms	<50 ms	<=16 ms	4 IP packets	1 error event per hour	<=6.68E-06
2.0	<200 ms	<50 ms	<= 16 ms	5 IP packets	1 error event per hour	<= 7.31E-06
2.5	<200 ms	<50 ms	<=16 ms	5 IP packets	1 error event per hour	<=5.85E-06
3.0	<200 ms	<50 ms	<=16 ms	6 IP packets	1 error event per hour	<=5.85E-06

Recommended Minimum Transport Layer Parameters for Satisfactory QoE for MPEG-4 AVC or VC-1 encoded SDTV Services (TR-126 Table 13)

Transport Stream bit rate (Mbps)	Latency	Jitter	Max duration of a single error	Corresponding Loss Period in IP Packets	Loss Distance	Corresponding Average IP Video Stream Packet Loss Rate
15.0	<200 ms	<50 ms	<=16 ms	24 IP packets	1 error event per 4 hours	<=1.17E-06
17	<200 ms	<50 ms	<= 16 ms	27 IP packets	1 error event per 4 hours	<= 1.16E-06
18.1	<200 ms	<50 ms	<=16 ms	29 IP packets	1 error event per 4 hours	<=1.17E-06

Recommended Minimum Transport Layer Parameters for Satisfactory QoE for MPEG-2 encoded HDTV Services (TR-126 Table 14)

Transport Stream bit rate (Mbps)	Latency	Jitter	Max duration of a single error	Corresponding Loss Period in IP Packets	Loss Distance	Corresponding Average IP Video Stream Packet Loss Rate
8	<200 ms	<50 ms	<=16 ms	14 IP packets	1 error event per 4 hours	<=1.28E-06
10	<200 ms	<50 ms	<= 16 ms	17 IP packets	1 error event per 4 hours	<= 1.24E-06
12	<200 ms	<50 ms	<=16 ms	20 IP packets	1 error event per 4 hours	<=1.22E-06

Recommended Minimum Transport Layer Parameters for Satisfactory QoE for MPEG-4 AVC or VC-1 encoded HDTV Services (TR-126 Table 15)

Considering that a single IP packet loss is an “error event” in the typical cable plant, the above tables can be simplified to that shown below:

RECOMMENDATION-22. *It is recommended that the thresholds for IP packet loss frequency (Loss Distance) derived from TR-126 [DSL Forum reference] are reasonable targets that may be tolerated by an average subscriber and should be met for end-to-end transport performance. These thresholds are no more than 1 error event per hour for SD programs and no more than 1 error event per 4 hours for HD programs and as shown in the table below.*

Transport Stream bit rate (Mbps)	Latency	Jitter	Loss Distance	Corresponding Average IP Video Stream Packet Loss Rate
<i>SD/MPEG 2 3.75 Mb/s</i>	<i><200 ms</i>	<i><50 ms</i>	<i>1 error event per hour</i>	<i><=7.8E-07</i>
<i>HD/MPEG 2 15.0 Mb/s</i>	<i><200 ms</i>	<i><50 ms</i>	<i>1 error event per 4 hours</i>	<i><=4.9E-08</i>
<i>SD/MPEG 4 2.0 Mb/s</i>	<i><200 ms</i>	<i><50 ms</i>	<i>1 error event per hour</i>	<i><=1.5E-06</i>
<i>HD/MPEG 4 8.0 Mb/s</i>	<i><200 ms</i>	<i><50 ms</i>	<i>1 error event per 4 hours</i>	<i><=2.4E-08</i>

Recommended Minimum Transport Layer Parameters for Satisfactory QoE for SD and HD services for cable

This can be still further simplified as shown below:

Transport Stream bit rate (Mbps)	Loss Distance
<i>SD/MPEG 2 3.75 Mb/s</i>	<i><24 errored Seconds / day</i>
<i>HD/MPEG 2 15.0 Mb/s</i>	<i><6 errored Seconds / day</i>
<i>SD/MPEG 4 2.0 Mb/s</i>	<i><24 errored Seconds / day</i>
<i>HD/MPEG 4 8.0 Mb/s</i>	<i><6 errored Seconds / day</i>

Five nines (99.999%) availability for every video at all locations in the network from the Head End encoder through the national/regional/metro core transport and through the last mile network including the CPE is a recommended goal and another perspective from which to view the loss specifications above.

99.999% availability to the subscriber allows for 315 seconds/year unavailable or less than 1 second per day. The TR-126 goals are for no more than 1 impairment per 4 hours at the subscriber for HD MPEG2 or ~6 errored seconds per day – in the same order of magnitude as the 5 nines goal. To meet 5 nines availability end-to-end requires that each

component in the system perform with even more nines. Since a subscriber can perceive many types of single packet loss events and burst packet losses are often perceived as a single event, it is reasonable to consider tracking the number of errored seconds (seconds with one or more packet losses) in determining the per-program availability numbers.

With continuous monitoring deployed for all programs, accumulated errored seconds per program can readily be tallied.

Of course each MSO may have their own requirements and targets for acceptable availability due to business reasons such as competitive pressures, available capital, operations expenses available, etc.

8.3.1. Tracking Jitter Margin

As described above, IP packet jitter is accommodated by utilizing a dejitter buffer to assure that a continuous stream of received data is available when needed by the decoding engine despite packet delay variations inherent in IP networks. It is important that the jitter (burstiness) of an IP flow not exceed the size of the allocated dejitter buffer or packet loss will be the result. Likewise, all network components that receive and forward flow packets like switches, routers, splicers, multiplexers, shapers, etc. also rely on internal queuing buffers to handle short term stream bursts, coincident flows, and temporary congestion events. It is important for these devices too that an IP flow does not exceed the size of allocated buffers or packet loss will be the result due to queue overflow.

RECOMMENDATION-23. It is recommended that all flows be continuously monitored for jitter using, for example, MDI [RFC 4445].

By continuously trending jitter performance, a warning can be generated alerting the operator to possible impending faults before a stream suffers packet loss and associated customer viewable impairment.

It should be noted that stream forwarding devices can be evaluated for their maximum jitter tolerance before deployment and the results used in adjusting warning and failure thresholds during operational monitoring.

8.3.2. Tracking Channel Change Times

The use of multicast techniques utilizing IGMP v2 or v3 for distribution of broadcast flows is increasingly common in many systems today using SDV and relies, in part, on network equipment performance in establishing a network route and the initiation of a stream upon demand from one or more viewers. While the reception of the user request by the SDV servers, message to the STB with tuning information, and configuration of the edge QAM also contributes significantly to channel change delays, an important

contributor of the delay is the time from when the edge QAM initiates the IGMP Join Request to when the network stream arrives at the edge QAM. (Note that the decoder must also first receive a PAT and PMT with the new channel information and sufficient queued information for decompression which adds to the network-contributed delays described here.) From experience, the total channel change time experienced by a user due to network systems under nominal operating conditions is composed of approximately 3 equal parts:

1. STB interactions with the SDV server
2. Edge QAM stream acquisition from the distribution network
3. STB stream queuing and decode

RECOMMENDATION-24. It is recommended that, for delivery systems using Multicast, IGMP channel change times as determined by the occurrence of an IGMP Join to the time of arrival of the requested stream be monitored at the edge QAM to help assure acceptable channel change performance by users.

9. Data Visualization, Reporting, and Export

The recommendations of section 3 results in data being acquired simultaneously from multiple, likely hundreds to thousands, of programs, from multiple locations in the network simultaneously and continuously operating thus resulting in large quantities of data to interpret for fault detection and isolation. There are many ways to present real time and historical trend information that can assist the operator in detecting and locating impairments.

RECOMMENDATION-25. To facilitate the use of the acquired monitor data for MMM, the following real time and historical presentations of the measured information are recommended to be made available to the operator at a minimum:

- *End-to-end probe results for each program showing program performance at all relevant probes*
- *Per program performance from probes in, at least, 15 minute interval aggregations. Other intervals may also be provided.*
- *Per program measurements from probe locations must show, at least, timestamped outages and transient loss events*
- *Per program historical views showing, at least, daily, weekly, and monthly program impairment summaries per probe*

10.MMM System Security Considerations

As described in previous sections, to accomplish the mission of end-to-end multimedia management including fault detection, isolation, and troubleshooting, programs must be continuously monitored at multiple locations for a variety of appropriate metrics. This obviously requires access to the streams currently being offered to subscribers in addition to selected control plane traffic.

Using the recommendations for acquiring the streams described in section 3.2 assures that independent monitoring devices are passive and will not affect the quality of delivered flows in the event of a probe failure. It should be noted that, depending on the placement of such independent probes, subscriber control plane traffic and offered streams can be tracked in addition to other possibly sensitive, proprietary, or copyrighted material. Non-encrypted programs can be examined. In addition, in the course of such monitoring, a significant amount of data traffic can be generated in communicating metric measurements in real time to a centralized management system or troubleshooting station. Because of these capabilities and traffic loads, it is recommended that operators deploying these systems consult with their in-house Information Technology departments regarding network designs for accommodating expected loads, for access control policies, and for other information security procedures that may apply.

11.Recommendations List

Recommendation-1. An effective operational Quality Assurance system that continuously monitors all distributed PIDs is recommended for an operator's modern high volume media over IP network.

Recommendation-2. To provide a cost effective solution for Multimedia Management and monitoring it is recommended that continuous program monitoring at multiple simultaneous strategic locations be deployed to make possible traditional "divide and conquer" troubleshooting for transient streaming media impairments.

Recommendation-3. To provide a cost effective solution for Multimedia Management and monitoring it is recommended that the particular set of parameters that might have been affected since the previous upstream monitoring location be measured and correlated.

Recommendation-4. It is recommended that for redundant service network-based components such as two switch/routers, each interfacing to a redundant core transport system (1+1 protected) and redundant downstream distribution system, the monitoring system should likewise be redundant and be connected such that monitoring can be sustained in the event of any single failure or during scheduled maintenance.

Recommendation-5. It is recommended that the monitoring equipment be powered with the same strategy as the local service providing equipment such as DC power, UPS backed AC, etc.

Recommendation-6. It is recommended that the metrics used to detect and evaluate stream impairments at a particular location should reflect the type of impairments that may occur from all upstream located processors located between the particular measurement location and the next upstream measurement location.

Supplementary metrics may be necessary to gain sufficient information about an issue for precise location and repair.

Recommendation-7. Because of the programs' high value at the egress from a Head End, it is recommended that all transmitted programs be continuously monitored close to the outputs of the site. Head End monitoring should include metrics specified in SCTE-142.

Recommendation-8. It is recommended that all program inputs to the Head End Site be continuously monitored including both digital and off-air feeds.

Recommendation-9. For redundant connections to downstream locations, it is recommended that all redundant paths be continuously monitored.

Recommendation-10. If the recommended monitoring points are not possible at a Head End for financial or other available resource constraints, the minimum recommended configuration is continuous program monitoring at the primary egress.

Recommendation-11. The monitor(s) should have adequate stream capacity to accomplish the monitoring of all programs for all the metrics recommended by this document series with a frequency of at least every 15 minutes.

Recommendation-12. The monitor(s) should have the ability to archive the data to network-based storage repositories allowing historical trending of the traffic.

Recommendation-13. The monitors should have a time synchronization capability such as Network Time Protocol (NTP) or other means to assure that all measurement locations can successfully timestamp monitored events such that all measurement points within a network maintain a local reference clock which matches all other local reference clocks within 1 second. This facilitates correlating measurements at different locations in the network.

Recommendation-14. It is recommended that all ingress programs at a Hub site from the regional transport network be continuously monitored using one of the recommended methods for stream access.

Recommendation-15. For Hub site configurations with redundant connections to a regional or national transport network, it is recommended that both ingress paths be continuously monitored.

Recommendation-16. *If the recommended monitoring points are not possible at a Hub site for financial or other available resource constraints, the minimum recommended configuration is continuous program monitoring at the primary egress (typically the HFC network.) For the HFC egress, it is recommended for the monitor to scan the transmitted channels. It is recommended that all transmitted channels be monitored within the HFC network at the output node(s) of the hub site such that all channels are examined within a maximum delay of 15 minutes.*

Recommendation-17. *For Hub sites that both receive from and originate programs to a Metro, Regional, or National transport network, it is recommended that all ingress programs from the regional transport network be continuously monitored using one of the recommended methods for stream access. For configurations with redundant connections to a regional or national transport network, it is recommended that both ingress paths be continuously monitored. It is also recommended that all transmitted programs to the transport network be continuously monitored. For the HFC egress, it is recommended for the monitor to scan the transmitted channels. It is recommended that all transmitted channels be monitored within the HFC network at the output node(s) of the hub site such that all channels in all node groups are examined at least every 15 minutes. These recommendations are also the minimum recommended monitoring configurations for this type of Hub.*

Recommendation-18. *For independent monitoring systems, the recommended methods for directing streams to a probe for monitoring and troubleshooting purposes include: Switch/Router SPAN/Mirror Port(s), Passive Optical Splitter, or Active IGMP Join of Multicast flows.*

Recommendation-19. *For monitoring unicast VOD or other types of traffic, an optical splitter or SPAN/Mirror port is recommended for use in production networks.*

Recommendation-20. *When using SPAN/Mirror Port(s), it is recommended that the health of the switch/router (CPU, memory usage, etc.) be actively managed as well to help assure that the switch/router normal forwarding operation is unaffected by the use of the SPAN/Mirror port .*

Recommendation-21. *It is recommended that for MPEG metrics described in SCTE 142 2007 (“Recommended Practice for Transport Stream Verification”), the thresholds for performance described in that document should be consulted.*

Recommendation-22. *It is recommended that the thresholds for IP packet parameters, the following thresholds derived from TR-126 are reasonable targets that may be tolerated by an average subscriber. These thresholds are no more than 1 error event per hour for SD programs and no more than 1 error event per 4 hours for HD programs and as shown in the table below.*

Transport	Latency	Jitter	Loss Distance	Corresponding
-----------	---------	--------	---------------	---------------

Stream bit rate (Mbps)				Average IP Video Stream Packet Loss Rate
SD/MPEG 2 3.75 Mb/s	<200 ms	<50 ms	1 error event per hour	$\leq 7.8E-07$
HD/MPEG 2 15.0 Mb/s	<200 ms	<50 ms	1 error event per 4 hours	$\leq 4.9E-08$
SD/MPEG 4 2.0 Mb/s	<200 ms	<50 ms	1 error event per hour	$\leq 1.5E-06$
HD/MPEG 4 8.0 Mb/s	<200 ms	<50 ms	1 error event per 4 hours	$\leq 2.4E-08$

Recommended Minimum Transport Layer Parameters for Satisfactory QoE for SD and HD services for cable

This can be still further simplified as shown below:

<i>Transport Stream bit rate (Mbps)</i>	<i>Loss Distance</i>
<i>SD/MPEG 2 3.75 Mb/s</i>	<i><24 errored Seconds / day</i>
<i>HD/MPEG 2 15.0 Mb/s</i>	<i><6 errored Seconds / day</i>
<i>SD/MPEG 4 2.0 Mb/s</i>	<i><24 errored Seconds / day</i>
<i>HD/MPEG 4 8.0 Mb/s</i>	<i><6 errored Seconds / day</i>

Recommendation-23. *It is recommended that all flows be continuously monitored for jitter using, for example, MDI [RFC 4445].*

Recommendation-24. *It is recommended that, for delivery systems using Multicast, IGMP channel change times as determined by the occurrence of an IGMP Join to the time of arrival of the requested stream be monitored at the edge QAM to help assure acceptable channel change performance by users.*

Recommendation-25. *To facilitate the use of the acquired monitor data for MMM, the following real time and historical presentations of the measured information are recommended to be made available to the operator at a minimum:*

- *End-to-end probe results for each program showing program performance at all relevant probes*
- *Per program performance from probes in, at least, 15 minute interval aggregations. Other intervals may also be provided.*
- *Per program measurements from probe locations must show, at least, timestamped outages and transient loss events*

- *Per program historical views showing, at least, daily, weekly, and monthly program impairment summaries per probe*