

JOURNAL OF NETWORK OPERATIONS



SCTE • ISBETM

Society of Cable Telecommunications Engineers
International Society of Broadband Experts

JOURNAL OF NETWORK OPERATIONS

VOLUME 3, NUMBER 1
October 2017

Society of Cable Telecommunications Engineers, Inc.
International Society of Broadband ExpertsTM
140 Philips Road, Exton, PA 19341-1318

© 2017 by the Society of Cable Telecommunications Engineers, Inc. All rights reserved.

As compiled, arranged, modified, enhanced and edited, all license works and other separately owned materials contained in this publication are subject to foregoing copyright notice. No part of this journal shall be reproduced, stored in a retrieval system or transmitted by any means, electronic, mechanical, photocopying, recording or otherwise, without written permission from the Society of Cable Telecommunications Engineers, Inc. No patent liability is assumed with respect to the use of the information contained herein. While every precaution has been taken in the preparation of the publication, SCTE assumes no responsibility for errors or omissions. Neither is any liability assumed for damages resulting from the use of the information contained herein.

Table of Contents

4	From the Editors
5	Introducing the Dense Multi-Mode Network Dan Dodson, Fellow, IBB Consulting Group LLC Jorge Gomez, Principal, IBB Consulting Group LCC Dhanashree Bhandari, Consulting Manager, IBB Consulting Group LCC
20	Deploying DOCSIS 3.1: Using Software Defined Radio, Machine Learning and Big Data to Improve Network Trouble Detection Patricio S. Latini, Strategy CTO, Intraway
34	The MoCA® PNM Paradigm Shift Rob Thompson, Director of Network Architecture, Comcast Maurice Manuel Garcia, Sr Principal Engineer, Comcast
65	Simplifying Field Operations Using Machine Learning Sanjay Dorairaj, Senior Director, Comcast Chris Bastian, SVP/CTO, SCTE/ISBE Bernard Burg, Senior Manager, Data Science, Comcast Nicholas Pinckernell, Data Scientist, Comcast
87	EPON Architecture Considerations for Intent-Based Networking Sebnem Ozer, Ph.D., Principal Architect, Comcast Nagesh Nandiraju, Ph.D., Senior Director, Comcast
95	An Innovative Design to Drive Spectral Efficiency in DOCSIS FDX beyond 25Gbps Xialong Zhang, Senior Engineer, Huawei Technologies Co., LTD. Tao Ouyang, Senior Engineer, Huawei Technologies Co., LTD. Syed Rahman, Principal Engineer, Futurewei Technologies Inc. James Jeng Chen, Principal Engineer, Futurewei Technologies Inc.

SCTE/ISBE Engineering Committee Chair:
Bill Warga, VP- Technology, Liberty Global
SCTE Member

SCTE/ISBE Network Operations Subcommittee (NOS) Committee Chair:
Ron Hranac
SCTE Fellow

Senior Editors
Ron Hranac
SCTE Fellow
Daniel Howard
SCTE Senior Member

Publications Staff
Chris Bastian
SVP & Chief Technology Officer, SCTE/ISBE

Dean Stoneback
Senior Director- Engineering & Standards, SCTE/ISBE

Rebecca Yaletchko
Technical Editor, SCTE/ISBE

SCTE • ISBE

Editorial Correspondence: If there are errors or omissions to the information provided in this journal, corrections may be sent to our editorial department. Address to: SCTE Journals, SCTE/ISBE, 140 Philips Road, Exton, PA 19341-1318 or email journals@scte.org.

Submissions: If you have ideas or topics for future journal articles, please let us know. Topics must be relevant to our membership and fall under the technologies covered by each respective journal. All submissions will be peer reviewed and published at the discretion of SCTE/ISBE. Electronic submissions are preferred, and should be submitted to SCTE Journals, SCTE/ISBE, 140 Philips Road, Exton, PA 19341-1318 or email journals@scte.org.

Subscriptions: Access to technical journals is a benefit of SCTE/ISBE Membership. Nonmembers can join at www.scte.org/join.

From the Editors

Thank you for downloading SCTE-ISBE *Journal of Network Operations* V3 N1, a publication of collected papers by the Society of Cable Telecommunications Engineers (SCTE) and its global arm, the International Society of Broadband Experts (ISBE). Several of the cable industry's best and brightest have contributed to this issue, covering topics that include full duplex (FDX) DOCSIS®, machine learning, proactive network maintenance (PNM) and MoCA, and DOCSIS 3.1 deployments.

We would like to thank the individuals who contributed to this issue of the *Journal of Network Operations*, including the authors, reviewers, and the SCTE-ISBE publications and marketing staff. We hope you enjoy this issue and that the selected papers stimulate new ideas and innovations in cable network operation. If you have feedback on this issue, have a new idea, or would like to share a success story please reach out to us journals@scte.org for consideration in an upcoming issue.

SCTE/ISBE *Journal of Network Operations* Senior Editors,

Ron Hranac

Technical Leader – Cable Access Business Unit, Cisco Systems, Inc.

SCTE Fellow



Daniel Howard

Director – Hitachi Energy and Environmental Efficiency, Hitachi Consulting Corp.

SCTE Senior Member



Introducing the Dense Multi-Mode Network

A New Frontier in Telecommunications

A Technical Paper prepared for SCTE•ISBE by

Dan Dodson, Fellow, IBB Consulting Group LLC
1628 JFK Blvd, Suite 1701
Philadelphia, PA 19103
dan@ibbconsulting.com
(609) 610-3652

Jorge Gomez, Principal, IBB Consulting Group LCC
1628 JFK Blvd, Suite 1701
Philadelphia, PA 19103
jgomez@ibbconsulting.com
(512) 799-5126

Dhanashree Bhandari, Consulting Manager, IBB Consulting Group LCC
1628 JFK Blvd, Suite 1701
Philadelphia, PA 19103
dbhandari@ibbconsulting.com
(651) 410-4671

Table of Contents

Title	Page Number
Table of Contents	6
1. Introduction	7
2. Americans Want Faster and More Ubiquitous Networks	7
3. There Are Three Use Cases That Simply Demand A New Type of Network	8
3.1. Smart Cities	9
3.2. Autonomous Driving	9
3.3. Gaming	9
4. Costs To Provide Capacity, Security And Interconnection Will Keep Rising, But Subscriber Growth Is Limited	9
5. What Can Be Done To Usher In A New Era Of Network Services?	10
6. Introducing The Dense Multi-Mode Network	11
6.1. DMMN Envisions A Hierarchy Of Network Providers	12
6.2. DMMN Benefits Will Make The Industry Stronger	12
6.2.1. Single-Network Consumer Service	13
6.2.2. Next Generation Network Synergies	13
6.2.3. Automotive Networking	14
6.2.4. Nationwide Virtual Private Network (VPN)	14
6.3. Specific Technical Innovation Will Make It Work Together	14
6.3.1. Dynamic Network Selection	15
6.3.2. Inter-Network Management	15
6.3.3. Shared Small Cell	16
6.3.4. Deep Fiber / Small Cell Integration	16
7. Conclusions	17
8. Abbreviations and Definitions	17
9. Bibliography and References	18

List of Figures

Title	Page Number
Figure 1 – Drivers of Network Demand	8
Figure 2 – Dense Multi-Mode Network Framework	12

1. Introduction

The opportunity to add mobile services as a fifth pillar to cable's stable of core offerings is significant. But this opportunity extends far beyond the obvious marketing and customer retention synergies that are often discussed. Operators also remain uniquely positioned to manage large scale integration of converged wired and wireless networks to support new services, applications and experiences.

Wireline, macro cell, small cell, home WiFi, public WiFi and internet of things (IoT) networks, including for automotive, machine-to-machine and home security are mostly managed in silos. The interfaces between these networks include organizational and security barriers. Keeping these networks separate and continuing to deploy and manage them on a one-to-one basis is cost prohibitive and does not fully exploit each network's unique capabilities and benefits. So how can these networks be unified to unlock value?

Using a combination of theoretical examples, supported by IBB's ongoing work with operators and proprietary analysis, this discussion will lay the foundation for operator development of dense multi-mode networks that will support the demands of the future.

2. Americans Want Faster and More Ubiquitous Networks

Industry professionals well understand that demand for capacity in the Internet and its tributaries is increasing at brisk rate. Video traffic has been the primary driver of Internet growth at the rate of 40-50% compound annual growth rate (CAGR). We also know that the number and type of devices are expanding perhaps exponentially. We're all busy upgrading and streamlining America's facilities-based networks to support the growth.

Cable and telco operators are busily driving fiber deeper into their networks, sometimes all the way to the home. Wireless operators are in early stages of planning for 5G-based small cells. Network elements are becoming simpler to manage via software defined networking (SDN) / network function virtualization (NFV) based equipment. Wi-Fi hotspots are pervasive, as are home-based wireless networks. Additionally, new networking technologies for internet of things (IoT) equipment and cars are being deployed.

In addition to video delivery traffic, operators can expect growth from:

- File back-up and cloud storage
- Cloud services access
- Video messaging and conferencing
- Automotive telemetry
- IoT uses of various types
- Augmented reality (AR), virtual reality (VR), mixed reality (MR)

This future state imagines that the trend towards consumer's demand for their purchases of services (video, voice and applications) will be separate from their device purchases (phones, TV cable boxes and home automation/security) and their networks (wireline and wireless). This is already happening to a degree and with good reason e.g., a Comcast subscriber watching Hulu over Wi-Fi using a phone bought from the Apple Store. Technical advances in services, networks and devices should happen independently of each other.

To support this future state, the service delivery ecosystem will need to flexibly support consumer demands and innovation not currently in the market.

Consumers are going to want:

- To pay for networking once, not 2 or 3 times
- Security
- Capacity everywhere, anytime
- Simplicity

Over time, demand will naturally drive network evolution.

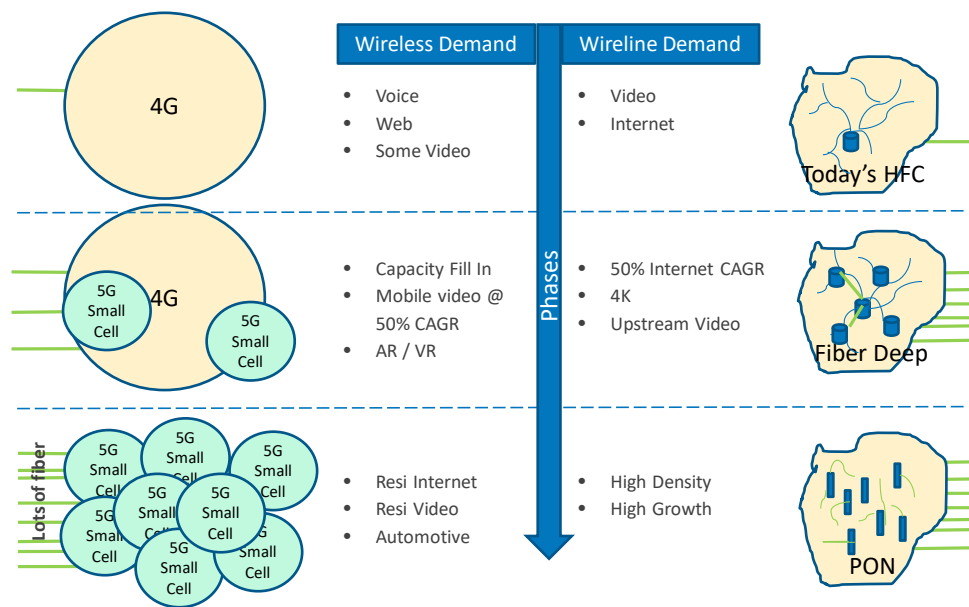

Figure 1 – Drivers of Network Demand

Today, each telco, cable operator and wireless provider is addressing these demands individually.

However, there is a possible future where facilities-based networks can leverage each other's deep fiber and small cells to reduce cost, increase the potential for new services, and enhance security. This future is a post-facility based industry that provides capacity everywhere the user or device needs it with a predictable quality of service (QoS). It's a future where network diversity is the norm. It's a future where things simply work.

3. There Are Three Use Cases That Simply Demand A New Type of Network

These use case are illustrative of the complexity needed in the network of the future.

3.1. Smart Cities

Smart city as the name suggests, is a program to digitize operations and communications to improve operational efficiency of services and infrastructure. Highly relevant use cases including parking space availability, 3D maps, efficient public transport, air pollution countermeasures, and stimulating green behavior have a huge dependency on connectivity, latency and processing.

To connect every dustbin in a park, which is a mostly static use case by nature, drives requirements such as latency insensitivity, intermittent network traffic flow but yet a solid need for coverage in distant and foliage heavy environments. These requirements often differ from other smart city applications e.g., optimizing public transport. Public transport optimization is a dynamic problem given the unpredictable environment. The later might not have stringent coverage requirements (roads have good wireless signal availability) but dependency on machine learning, high processing power, latency sensitivity will still be high.

A city would rather lease a network or networks for the various use cases under a single service level agreement (SLA) than try and build and maintain a greenfield serves all network.

3.2. Autonomous Driving

As car manufacturers move from being just a hardware provider to a hardware, software and experience provider, connectivity is determined to be at the heart of the new service model. Car manufacturers are not looking to operate or build networks, but rather focus on building applications inside the car platforms and in the cloud which will interact to serve this dramatically changing marketplace.

As these independent cars could drive everywhere from forests to urban areas, in tunnels, across bridges, underground parking – the only way to provide this ubiquitous coverage is through a network of networks with which the car manufacturers can have a single business relationship.

3.3. Gaming

Imagine networked VR games where players are connected to each other and to servers by a high bandwidth, low latency, on-demand, roaming network connection. This can only be done by creating temporary tunnels (via MPLS) across network boundaries via SDN.

4. Costs To Provide Capacity, Security And Interconnection Will Keep Rising, But Subscriber Growth Is Limited

Almost every wireline provider (cable operator or telco) is rushing to expand capacity to meet demand. Cable operators are pushing fiber deep into their hybrid fiber coax (HFC) networks in order to reduce node sizes to well under 100 homes passed. A side benefit of this upgrade is to increase useful spectrum in the HFC plant from 750 or 860 MHz to over 1 GHz. In addition, they are deploying DOCSIS 3.1 modems and cable modem termination systems (CMTS) to increase spectral efficiency of data networking on the coaxial portion of the network. They envision a future where DOCSIS can support a full duplex version of the protocol that greatly increases the upstream capacity of the plant. All of this is done by removing passive elements in the network (amplifiers) and moving the physical interface for DOCSIS out of the edge facilities (hubs) and into the field. This is an expensive endeavor ranging in cost from \$500 to \$700 per home passed.

In some cases, particularly in urban environments and to new construction multi-dwelling units (MDUs) operators are deploying fiber-to-the-home (FTTH) either using Ethernet passive optic

network (ePON) or Gigabit-capability passive optic network (gPON) that enables 10 Gbps upstream and downstream capacity. These upgrades are more expensive at \$800-\$1000 per HHP but are also more future proof.

Several telcos are deploying similar architectures that either shorten in time or cost their DSL-based last mile deployments, or are alternately building their own FTTH networks.

Wireless operators face the challenge of filling in high density areas with 5G small cells. A typical small cell covers ~200 meters in radius. Though the radius is dependent on which frequency is used, morphology of the area, demand, and foliage, a simple back-of-the-envelope calculation leads to a requirement for thousands of small cells for a small geography. Wireless operators are increasingly pushing through backhaul, power and mounting challenges to densify their networks. Backhaul and co-location through/with deep fiber networks resolves some of these challenges.

Traditional infrastructure vendors (i.e. Crown Castle, American Tower) have increased investments to move up the connectivity value chain, accumulating facilities in the hope of potentially launching neutral host and private networks

With a lot of the capacity constraints occurring in densely populated areas, real estate holding entities have also begun evaluating network connectivity (and specifically NHC) as an additional revenue stream.

The growth of traditional wireline and mobile operators in the U.S. may be limited due to a glass ceiling, made up of:

- Fixed number of customer interactions (i.e. quad play)
- Saturated fixed addressable market smart phones and broadband home deployments

Operators have been going for growth by vertically integrating through buying content companies and expanding into adjacent services (e.g. home security). Growth in the core networking business has slowed as the operator is limited by the scope of its own footprint.

There are also technology design issues to overcome. In traditional network buildouts, most network functionalities are hardcoded into proprietary network equipment which have been custom designed to serve the defined siloed purpose. Interworking between different radio access technologies (RAT) needs additional standardization between disparate industry groups e.g., Wi-Fi Alliance & 3GPP thus adding additional complexity. This makes gluing networks together a challenge.

5. What Can Be Done To Usher In A New Era Of Network Services?

In many ways, the telecommunications industry is already evolving to a multi-layered system of business operations and facilities. Cable operators do provide backhaul connectivity to wireless operators. Mobile virtual network operators (MVNO) operate around the world today and networked devices can be made to switch between network options.

However, none of these are particularly seamless or integrated at a deep level. To determine which evolutions are needed to create a high capacity network experience that is always available and secure and profitable for all parties involved, the following issues must be addressed:

- How can networks be made transparent to consumers and their devices?
- How can 5G wireless be economically deployed?
- How can service be delivered across networks?

- How can multiple networks be managed as one?

6. Introducing The Dense Multi-Mode Network

When it comes to a network operator's core competency, connectivity, wireline and wireless worlds have begun colliding, with mobile networks having capacity constraints and needing to increase their asset count exponentially and into areas where wireline operators have made heavy investments and own large catalog of facilities. This creates an organic wired/wireless infrastructure overlap, solved by what will be called the 'dense multi-mode network.'

The dense multi-mode network (DMMN) is broadband and pervasive and its made up of all the available network types (3G, 4G, 5G, Wi-Fi, PON, DSL, HFC, Ethernet, Zigbee, Z-Wave, etc.). The dense multi-mode network is everywhere and its really one thing stitched together not a lot of siloed things.

If the network is one thing instead of many, and boundaries become traversable, then services would be able to better navigate the network through the creation of inter-network paths (MPLS-based) that traverse facilities-based networks to connect devices to servers and devices to devices no matter where they are.

To enable the dense multi-mode network several evolutions are needed:

- The ability to manage disparate networks as "one" operational layer, The master network operator, will need to exist. This flexible inter-network connectivity implies a different arrangement between network facilities operators (wireless and wireline).
- Specific technical evolutions in device software for network selection, SDN/NFV software for inter-network management, mobile cloud radio access network (CRAN) sharing and remote fiber node /small cell integration.
- Finally, business cases need to be built to prove out fundamental growth and cost reduction opportunities in nation-wide VPN deployment, automotive networking, single-network consumer service and small cell sharing / backhaul.

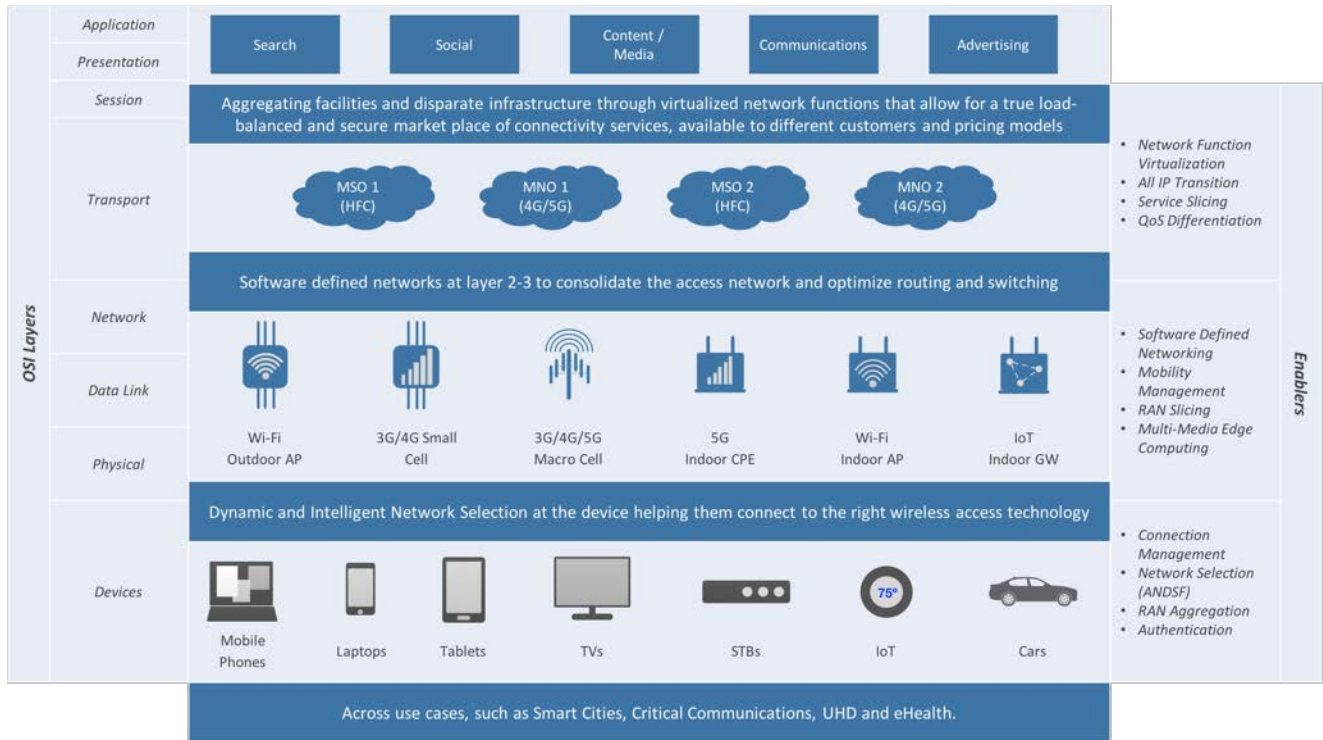

Figure 2 – Dense Multi-Mode Network Framework

6.1. DMMN Envisions A Hierarchy Of Network Providers

Master network operators would deliver “connectivity as a service (CaaS)” via an IP marketplace to any type of customer (B2B, B2C) across multiple facilities based operators. In some ways, this happens today. MVNOs are reselling the wireless networks of facilities-based carriers all around the world. In fact, some cable operators are reselling wireless networks in addition to their own wireline networks. What doesn’t quite happen though are network offerings that span multiple facilities networks. Not yet.

An IP marketplace that enables CaaS helps application providers with optimized paths of delivery for their services while allowing network infrastructure and facility owners to optimize usage across their assets, allowing them to funnel their investments to the right areas. Imagine a gaming service that can establish a persistent high-quality connection between gamers across the U.S.

Mobile and wireline facilities operators can look to increase investments in their core competency, network connectivity, and compete based on network quality and functionality. This doesn’t imply that today’s cable and telco operators get out of their B2C or B2B sales and marketing roles, rather they can be expanded. The ability to resell the networks of other operators grows the market by increasing the ability to see new services much more easily.

6.2. DMMN Benefits Will Make The Industry Stronger

There are numerous benefits to being able sell connectivity across networks and to sharing facilities. To build the dense multi-mode network, industry leaders will need to build business cases that bring to light the

opportunities inherent in sharing facilities and allowing full-featured network interconnection at the protocol level.

The good news is that the stars have aligned to make this possible.

6.2.1. *Singe-Network Consumer Service*

With no owned assets to ‘rent’ and no traditional rich content or multimedia services (i.e. video, voice) to offer, the master network operator can be wrongly assumed to just be a ‘dumb pipe’ provider. However, with the onslaught of devices and services in the industry, they can increase the value of a ‘dumb pipe’ through ‘smart access’.

Connectivity as a service provides the master network operator with a simple value proposition through an increased number of customer touchpoints across:

- Mobile phones, tablets, smartphones
- Fixed households
- Connected devices (TVs, IoT)
- Virtual network operators
- Application service providers (i.e. content)

The simplicity of the offering can also allow for flexible pricing or service-offering tiers:

- Service-based (AR vs. IoT vs. HTTP vs. video vs. voice)
- Demand-based (wireless in high density areas @ peak times would be more expensive than, say, FTTH)
- Demand-based services could be by:
 - Geography (urban vs. suburban vs. rural)
 - Access method (wireless vs. wired)
 - Time (h)
 - A combination of all three
- Consumption-based (more GB, lower cost/per GB)

Increasing the number of customer touchpoints and types of customers while maintaining a streamlined set of services (with flexible pricing offering) can help the master network operator redefine the concept of average revenue per user (ARPU) simply by enabling services across a larger scale!

6.2.2. *Next Generation Network Synergies*

For next generation networks, thoroughly biased on small cell like deployments, neutral hosting and fixed wireless backhaul aren’t necessarily new concepts. However, serious business cases that explore the benefits of these emerging technologies are not widely developed or understood.

Small cell deployment today, is primarily thought of as an infill solution. A 5G cell might be deployed to provide coverage in a dense area where today’s macro-sized 4G could no longer provide adequate capacity.

However, the cost for an operator to deploy its own 5G radio to service to what could be an area the size of a city block would be prohibitive.

To enable broad deployment of 5G cells, deployment cost must be dramatically lowered for all operators. This implies that the radio be shared amongst mobile operators and that backhaul and possible co-location be provided by the new generation of remote fiber nodes that cable operators and telcos are deploying.

The detailed business case for the cost benefit of this arrangement must be based on deploying into the future state configuration of the HFC, DSL, FTTH and FTTB networks, not today's network.

There is an opportunity for new facilities-based operators to build this network and then lease capacity back to legacy wireless or wireline operators to enable enhanced service or to simply offload peak demand. Offloading peak demand in the cable network for instance could save cable operators the cost of deploying capacity in the wireline network to meet "peak of peaks" capacity needs. This is good example of how a master network operator could leverage the benefit of access to multiple network facilities.

6.2.2.1. *There Are Many Examples Of Facilities Sharing From Around The World*

It is possible to share wireless networks with various levels of integration. Multiple options including site sharing, radio equipment sharing all the way to sharing backhaul are possible options. Newer models like neutral hosting are encouraging an even deeper long-term evolution (LTE) network sharing into the 3GPP evolved packet core ¹

- Network sharing is very popular in the nordic countries, in which operators share the RAN - infrastructure and spectrum
- To cover rural areas, a capex heavy investment, DNA & TeliSonera in Finland have built a shared 4G network, Telia and Tele2 in Sweden run the 4G network together
- Tower sharing is common in Africa and Asia as well the US. e.g., joint ventures like Indus Towers in India host most major operator RAN equipment in a sharing arrangement
- In the U.S. towers owned by individual wireless operators now make up less than 5% of the total²

6.2.3. *Automotive Networking*

Automobile telemetry is widely seen as a new and important application for networking both between cars and to services. Providing a robust and versatile infrastructure could very well be beyond the ability of any one network provider. However, if connectivity as a service can be providing to an auto manufacturer that allows cars to roam across network boundaries based on the strength of the local signal or its capacity, the functionality of auto-telemetry would be greatly enhanced. The business case for this type of service should imagine near term applications in addition to the availability of macro 4G, small cell 5G and Wi-Fi network access.

6.2.4. *Nationwide Virtual Private Network (VPN)*

If you wanted to sell a VPN service to a corporation that wanted to securely connect employees working at home, how would you do it? A master network operator with access to the facilities connecting homes and mobile devices across the entire country would be helpful. The benefits of such a capability extend from not only lowering the cost for deploying large dispersed VPNs to business and home locations but also to improving the overall security of such a network.

6.3. Specific Technical Innovation Will Make It Work Together

There are four missing ingredients needed to enable a master network operator to operate a dense multi-mode network:

- 1) Dynamic network selection in the device
- 2) A SDN/NFV based inter-network management layer
- 3) Shared small cell CRANs
- 4) Integration of the deep fiber node and CRAN

None of these are necessarily new concepts. However, putting them together in the context of how a master network operator would do business makes them important industry evolutions.

6.3.1. Dynamic Network Selection

Dynamic and intelligent network selection at the device is a 'killer' app. Understanding that the industry is moving towards a bring your own device (BYOD) model that is coupled with increasing types of wireless access technologies, the devices' ability to select the right network at the right time has become critical.

By developing dynamic and intelligent network selection, both at the device (through connection management) and at the access point through access network discover and selection function (ANDSF), a master network operator can help steer a device to the right network at the right time.

This can enable multiple benefits:

- Increased application quality of service
- Cost-benefit by preferring an unloaded network where cost per MB is cheaper
- Reduced user interaction, allowing for seamless selection and transition of network selection that becomes invisible to the application

Several advances in networking ³ are important to enable dynamic network selection including:

- Architectures designed to be more and more access technology agnostic e.g. non-cellular accesses
- The ability for devices to maintain multiple IP sessions, each with a different granular flow and QOS profile to connect to same or different data networks e.g., the internet, intranet or servers within dynamic network boundaries
- Modularized functionality to enable dynamic network behavior and evolution propensity
- Support for mobility on demand to distinguish mobility levels and to predictively determine mobility patterns e.g., IoT sensors can be operated in a mobile originating mode only and attach only for uplink
- Eliminating gateway functionality and de-linking IP flows from one another

6.3.2. Inter-Network Management

For the dense multi-mode network to become useful, it must be possible to aggregate network infrastructures and facilities, i.e. the killer network. This is done by leveraging disparate network infrastructure assets and facilities scattered across the country (traditionally owned by both mobile and wireline operators and other telecommunication entities). To connect networks at the protocol level connections would be established using software-defined networking (SDN) for optimize routing/switching and network function virtualization (NFV) for load-balancing, dynamic scaling of functionalities and security. With this management layer in place, master network operators can truly disassociate the application from the underlying network. This enables a true 'IP marketplace' where an application can come in and use network resources based on:

- Application requirements (i.e. latency, throughput)
- Cost
- Security requirements

Network function virtualization is a must to reduce dependency on network hardware by soft coding the network function on commercial off the shelf (COTS) hardware. Adding flexibility to the function for interworking, partitioning, scalability or to support the variance in requirements becomes a parallel effort to ongoing operations and maintenance (OAM) along with expansion.

Several advances in networking are important to enable protocol level network interconnection:

- A move in upcoming network architecture designs from specifying interfaces and protocols between entities to defining them between network functions (access, mobility, policy, security etc.) and planes (data, control etc.)
- Openness to support network functionality transcribed into dedicated or virtualized instances
- Support for multiple levels of secure access based on application or user selection triggers e.g. non-SIM authentication, certificates, username-password
- Separation of the user plane and data plane for independent scaling and distributive factors. This helps support a bigger range in latency on the same network

6.3.3. Shared Small Cell

Radio access network equipment will need to be deployed that can allow any compatible device to connect and then be routed based on policies implemented in the cloud. This type of connectivity is heavily dependent on low latency network access and therefore CRAN-based radios must be connected by GbE level connections to cloud servers.

Sharing is a viable option if equipment is based on common standards (e.g. disparate 3GPP network equipment belonging to 2 operators can be much easily integrated than a 3GPP and a non 3GPP like Wi-Fi).

However, there are challenges³ to overcome in deploying shared cells

- Network requirements of different applications vary across extreme ranges e.g., Latency vs. processing power. Network design is challenging when supporting scalability for different requirements e.g., residential IoT vs. electronic health or eHealth.
- Shared networks need the security aspects of managing information exposure, isolation and regulatory requirements e.g., financial organizations and YouTube videos sharing common transition paths
- To meet stringent SLAs, operators require dedicated resources over shared networks. This requirement essentially limits the networks inherent ability and potential to multiplex e.g., LTE Radio access network (RAN) scheduling
- Novel algorithms and limiting choices is a trade-off to improving efficiency of shared resources e.g., SAS, LTE-TDD configs in the CBRS band
- Moving access point or cell reselection from UE or RAN to the core network to support session transition across multiple accesses

6.3.4. Deep Fiber / Small Cell Integration

Wireline operators are deploying fiber deep into the network over the next several years. For a cable HFC operator this implies that a fiber node with GbE connectivity will be deployed to serve as few as 60 homes. The geographic area this represents is similar to the area covered by a 5G small cell (200M radius). It stands to reason that there is interest in using the deep fiber cable plant for small cell backhaul.

Several cable operators have recently begun to analyze the opportunity for providing backhaul for future 5G small deployments⁴. The analysis shows that a large portion of needed cells could be supported by connecting to new fiber interconnect points.

The devil is in the details however.

- Node and radio cell placement will need to be coordinated in order minimize construction and permitting costs.
- Physical fiber nodes and RANs designed for connectivity will be necessary.

- Remote PHY nodes (which are served by GbE) will draw power from the existing HFC network. This power level is not likely to be sufficient to support the power needs of a 5G radio in addition to the DOCSIS interfaces connected to coax.

These are problems to be solved and given, the alternatives for backhaul (building new fiber), not insurmountable.

7. Conclusions

There is a visionary business to be had in creating a new kind of networking. This paper calls out some of the key challenges and opportunities but it is up to leaders in the industry to see how these disparate technologies and sometimes counter-intuitive opportunities can work together. Connectivity as a service based on the dense multi-mode network is a new frontier for both incumbent operators, networking entrepreneurs and service providers who can leverage these new capabilities.

8. Abbreviations and Definitions

5G	5 th Generation
ANDSF	Access Network Discover and Selection Function
AR	Augmented Reality
ARPU	Average Revenue per User
SLA	Service level agreement
BYOD	Bring your own device
CaaS	Connectivity as a Service
CBRS	Citizens Broadband Radio Service
CMTS	Cable modem termination systems
COTs	Commercial off the shelf
CRAN	Cloud radio access network
DMMN	Dense Multi-Mode Network
ePON	Ethernet Passive Optic Network
FTTH	Fiber-to-the-home
gPON	Gigabit-capable Passive Optic Network
HFC	Hybrid fiber coax
HFC	Hybrid Fiber-Coax
IoT	Internet of Things
LTE	Long-Term Evolution
LTE-TDD	Long-Term Evolution – Time Division
MDU	Multi-dwelling units
MPLS	Multiprotocol Label Switching
MR	Mixed Reality
MVNO	Mobile Virtual Network Operators
NFV	Network function virtualization
OPAM	Operations and maintenance
PHY	Physical
QoS	Quality of service
RAT	radio access technologies
SAS	Spectrum Access System
SDN	Software-defined networking

UE	User Equipment
VR	Virtual Reality

9. Bibliography and References

¹ [“Mobile Infrastructure Sharing: Trends in Latin America”](#), Daniel Leza, TMG, ITU Regional Economic and Financial Forum of Telecommunications/ICTs for Latin America and the Caribbean San Jose, Costa Rica – 12 March 2014

² [Top 3 Cell Tower Companies in the U.S.](#), Chris Neiger, The Motley Fool, October 15, 2016

³ [Network Slicing to Enable Scalability and Flexibility in 5G Mobile Networks](#), P. Rost(1) , C. Mannweiler(1) , D. S. Michalopoulos(1) , C. Sartori1 , V. Sciancalepore(2) , N. Sastry(3) , O. Holland(3) , S. Tayade(4) , B. Han(4) , D. Bega(5,6) , D. Aziz(1) , and H. Bakker(1), (1) Nokia Bell Labs Germany, (2) NEC Laboratories Europe, (3) King’s College London, (4) University of Kaiserslautern, (5) Univeristy Carlos III of Madrid, (6) IMDEA Networks Institute

⁴ [Comcast: Our Network’s Ready for 5G](#), Mari Silbey, *Light Reading 5G*, March 6, 2017

Deploying DOCSIS 3.1: Using Software Defined Radio, Machine Learning and Big Data to Improve Network Trouble Detection

A Technical Paper prepared for SCTE•ISBE by

Patricio S. Latini
Strategy CTO
Intraway
+1 (305) 504-9250
patricio.latini@intraway.com

Table of Contents

Title	Page Number
Table of Contents _____	21
1. Introduction _____	22
2. Why Software Defined Radio? _____	22
2.1. Detecting Cable Leakage with SDR _____	24
3. Why Bigdata? _____	25
3.1. Mining the Data _____	26
4. Putting all Together _____	27
5. Conclusions _____	31
6. Bibliography _____	31
7. Abbreviations & Acronyms _____	32

List of Figures

Title	Page Number
Figure 1 - Ideal Software Defined Radio Receiver.	23
Figure 2 - Block Diagram of a Real-Time SDR Capture and Processing Box	23
Figure 3 - Wideband Spectrum Capture with signature matching	24
Figure 4 - Example of a Common Collection Layer Framework	27
Figure 5 - Predictive/Corrective Use Case using SDR Supplied Data	28
Figure 6 - SDR Based RF Leakage Detection Visualization	29
Figure 7 - Affected Cable Modem Downstream Spectrum Visualization	30
Figure 8 - Visualizacion of Downstream Spectrum to Channel Map for Video Issues	31

List of Tables

Title	Page Number
Table 1 - Predictive/Corrective Use Case Network Data	28

1. Introduction

Deployments of DOCSIS 3.1 are ramping-up. The usage of orthogonal frequency division multiplexing (OFDM) is fast becoming the standard. And there are now new problems from the same old suspects: radio frequency (RF) ingress and RF leakage.

With 3.1 putting OFDM modulation and its high peak to average power ratio (PAPR) levels in cable and long term evolution (LTE) doing the same thing in the air, problems caused by physical cable damage increases significantly and is bi-directional. And it is the multiple system operator (MSO) customers who pay the price of RF ingress, while the MSO is exposed to the regulatory issues of RF leakage into the LTE bands.

The traditional approach of RF leakage detection is time and resource consuming. This drives up costs, slows down corrections, and increases subscriber and carrier frustration.

This paper proposes a new approach, using low-cost, automated, mobile leakage detectors and real-time data aggregation and analysis. It shows how using a combination of software defined radio (SDR) leakage detectors, uploading the collected data to a central repository, and then performing sophisticated analysis can generate a real-time or near real-time warnings of probable RF problem locations.

Then the need for generalization of API methods exposure of network information and big data are discussed, as key enablers for handling high volumes of data in standardized ways, to provide useful data to analytics applications.

Using machine-learning algorithms to analyze geo-referenced RF leakage data along with existing data available from the network changes everything. Combining available data, such as downstream and upstream spectrum capture, as well as other readily available information with the geo-referenced leakage data can provide, in real-time, results with much greater accuracy and speed in detecting and locating RF issues, as well as an analysis of the actual impact.

Second level analysis can then present additional correlations with other indicators such as call center trouble calls per region, active probes information, and others.

2. Why Software Defined Radio?

Software defined radio is a radio communication system where some of the components that typically are implemented as hardware elements are converted to software functions. Moving some key functions of a radio system for hardware to software brings a lot of advantages with the main one being the flexibility to adapt to new protocols or waveforms without the need to physically change the components in the transceiver.

Figure 1 shows the block diagram of the main components of a software defined radio (SDR) receiver. For many years the main limitation to implementing affordable SDR systems was related to the high cost and power requirements of the frontend analog to digital converters (ADCs) and the much costlier field programmable gate arrays (FPGAs) required to perform the digital signal processing function.

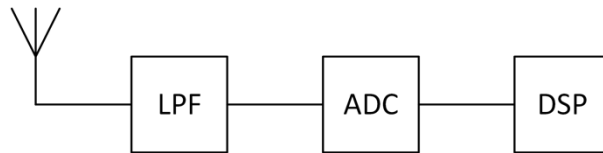

Figure 1 - Ideal Software Defined Radio Receiver.

Nowadays, given the real-world consequence of Moore's law, the digitalization capacity of the ADCs plus the much more powerful FPGAs have brought the capabilities of easily capturing and processing samples of up to 30 MHz of RF spectrum at reduced costs. A good example, among several others, of a powerful and very cost efficient SDR receiver is the open source project LimeSDR which brings a capture bandwidth of 61.44 mega samples per second (MSPS) with a 12 bit resolution per sample which is more than enough due to Nyquist theorem to provide a clean 25 MHz of RF bandwidth capture.

In parallel the miniaturization of microprocessors and computers has allowed the integration of enough computing power in a small board space with low enough power demands to have the required post processing capacity in as an integrated standalone device what can be easily fitted in a car or motorcycle for autonomous collection. Some examples of these platforms are the Raspberry PI 3 or the ODROID-XU4.

Lastly, the final two key elements for an agile SDR-based RF capture solution are the ability to report its data to a centralized data repository in an automated and real-time or near real-time fashion and the capability to provide geolocation coordinates where that data came from. For the first, the ubiquity of LTE connectivity and/or WiFi community networks are the enablers to support the connectivity requirements for an integrated solution and the second is solved by the inclusion of a global positioning system (GPS) receiver as shown in Figure 2.

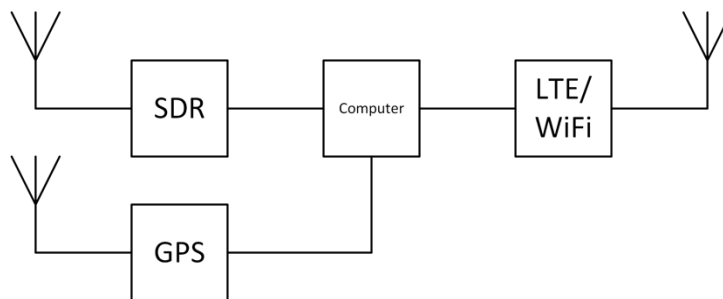

Figure 2 - Block Diagram of a Real-Time SDR Capture and Processing Box

In our lab and field experiments we have been able to create a SDR capture and processing box by integrating commercial off the shelf (COTS) hardware (SDR, computer, LTE modem and GPS) in an enclosure with dimensions of 20cm x 12cm x 4 cm. We think that these dimensions can be reduced significantly by putting all the functions in a custom printed circuit board (PCB).

This level of integration allows the inclusion of a battery to create a completely standalone device that in our field tests could be put in a back pack to perform RF leakage discovery in very dense urban areas where is very difficult to perform drive tests.

One important aspect of mobile solutions and particularly in the battery supported ones is its power efficiency, and in that field, the power requirements of the connectivity solution for data reporting is a significant contributor, so reducing them may provide appreciable benefits to the overall battery life. Several emerging standards for internet of things (IoT) data backhauling provide solutions for this problem from with some of them such as LTE cat M1, LTE cat NB1 (NB-IOT) and long range wide area network (LoRaWAN) can be mentioned.

Each of these low power, narrowband data transmission standards have its own advantages and challenges, however any of them is a viable alternative for reducing power consumption and costs for the mobile solution.

2.1. Detecting Cable Leakage with SDR

There are two approaches to detect cable leakage with SDR:

- Leakage Detection Using Test Signal Phase
- Wideband Spectrum Capture with signature matching

Leakage Detection Using Test Signal Phase - as described in [2] is based on the detection of a specific continuous wave (CW) signal injected in the cable network, typically using one of the automatic gain control (AGC) pilots and the measurement of the presence and phase of this signal in the air with two receivers, together with mathematical construction of a synthetic phased array. This process allows pinpointing the leakage location with an accuracy better than 5 meters the source of a leakage if the SDR receiver and the CW generator are driven with a clock precise to the order of 0.1 parts per billion (ppb), which is a rubidium standard clock. This approach brings enormous benefits given to its accuracy in reducing the time to find where the physical problem that is causing the leakage as basically the precision is just limited by the GPS reporting accuracy.

Wideband Spectrum Capture with Signature Matching - in this method the SDR captures a wideband spectrum, typically near the maximum available to the SDR sampler in a predefined frequency band and performs a fast Fourier transform (FFT) which compares the identified spectrum signature with the MSOs used spectrum in that band as show in figure 3.

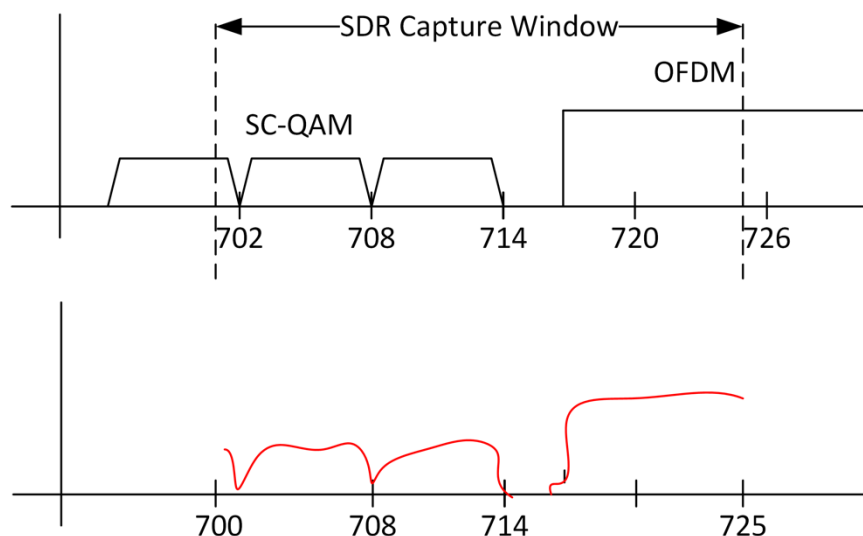

Figure 3 - Wideband Spectrum Capture with signature matching

A positive match of a spectrum capture of the MSOs signature in the air, has proven to be in our field tests to be a very powerful detector of strong leakage. However, its precision is inferior to the test phase method, but with the flip side is that it detects strong sources of leakage and does not require the strict timing requirements that the former has.

3. Why Bigdata?

MSOs have been collecting data from network devices for specific applications like service assurance, usage-based billing, and rating measurement, however the traditional approach has been based on application silos. In the last few, with the appearance of the “big data platforms”, some service providers have been trying to shift to a new paradigm where all the data coming from the network and user devices are mined in a single data warehouse and each application uses the data sets that it requires for its purpose from that single information source.

The big data concept is more than just the storage of data; it is having the software tools with the capacities to capture, curate, manage, and process this volume of data in business useful manners.

Based on this definition, several telecommunications standards organizations have been working in the last few years in efforts to define best practices and use cases for big data and particularly TMForum has released a detailed document about big data best practices [3]. In that document, there are two particular use cases that are closely related to the usefulness of leakage data:

R-NRAM-2: Predictive analysis of Network Faults, Traffic performance and location based product impact analysis

and

R-NRAM-3: Network Fault Location & Recovery

Below there is a short transcript from the TMForum best practice of the story associated with each use case.

“Predictive analysis of Network Faults, Traffic performance and location based product impact analysis

Product performance of same or competitive vendor on social sites can help business leader to identify the sentiments of people in that particular region and that can be correlated with the fault and performance of network in that particular region. This impact analysis can help in predicting the future investment in that particular region or to improve the service quality.

Many time though we do proactive monitoring of devices however we forget to check the overall behavior of same type of device at network level because of reactive analysis. If any problem occurs the effort is to identify the root cause of the problem at device level and to solve it. Even the service and network impact analysis does not help. However the same behavior may be occurring in other devices and may be the culprit is the model of that particular device. Such prediction can be done using Big data analysis.

Historical database of geographical, social, financial events can be linked with the historical data of network events and that can be analysis to build the traffic pattern during these events. Big data analytic can play a big role in making these patterns across the globe for any

CSP's network. It will not only provide the stress network handle during the event but will tell how to predict the faults which can occur and how CSP can plan the remedies to convert challenge into opportunities.

Social networking sites are becoming a big source of information of human sentiments around any product. The CSP before launching a similar product in a region can do sentiment analysis of other service provider product to understand the behavior of human for that product, so the product can be customized according to the behavior of people in that geographical region. At the same time social sentiments trigger any product to get success or failure in the market. If that kind of analysis is done the CSP can take appropriate decision before expanding the network or to launch a new product in the market.

Financial crisis or stress on economy also triggers sentiments and almost similar human behavior. This can either put stress on the network or reduce it. A close steady can help CSP to predict traffic flow, device behavior and cause of concern from sales/marketing point of view. This will help them to plan accordingly.”

“Network Fault Location & Recovery

In this use case, big data analytics (BDA) is applied in order to automatically identify the presence of a fault, congestion, or performance deterioration within the CSP's network from the available CSP data, including network alarms, network performance metrics, and log files from network domains of multi techniques. BDA is also applied to look at fault recovery manually by humans in order to learn the appropriate actions to take to recover from different types of faults and the success of these actions.

The application of big data analytics improves the automation level as part of the network management process. Faults can be located and recovered without human intervention, and the overall process can be made faster and more accurate. This is especially important for multi-layer networks, where the root cause analytics would normally be performed manually one network layer at a time. Having the capability to automatically resolve the fault across all layers reduces the operational expense of fault location and recovery and enhances the efficiency of the fault management process.”

From both use cases, it is evident that deep correlation of big data analysis of network information, coupled with geographical and external information like the RF leakage, can provide very useful information to predict and correct service failures, something which the commonly used direct correlation tools cannot always provide.

3.1. Mining the Data

In order to have a well populated data warehouse, the first step is to scale up on the data mining tools. Cable operators have relied for many years, and some still do with an army of different tools and custom scripts, to get information from the different network elements such as cable modems, cable modem termination systems (CMTS), converged cable access platforms, set-top boxes, routers, optical equipment, etc. Primarily caused by the lack of adoption of standards, to mine and store the data, all this had the consequence that the information was scattered in several different databases and sometimes the same data was collected twice by different platforms.

In the short to medium term, it will be very difficult to create and adopt a standardization protocol on how to access the information in the network elements, given the diversity of protocols (simple network management protocol (SNMP), syslog, command line interface (CLI), trivial file transfer protocol (TFTP) Files, IP detail record (IPDR), etc.). However, the definition of a standardized middle collection layer with a well-defined northbound protocol, that support extensible APIs, might be a key

enabler for the success of any consolidated high volume collection. An example collection layer is described in figure 4.

Architecture

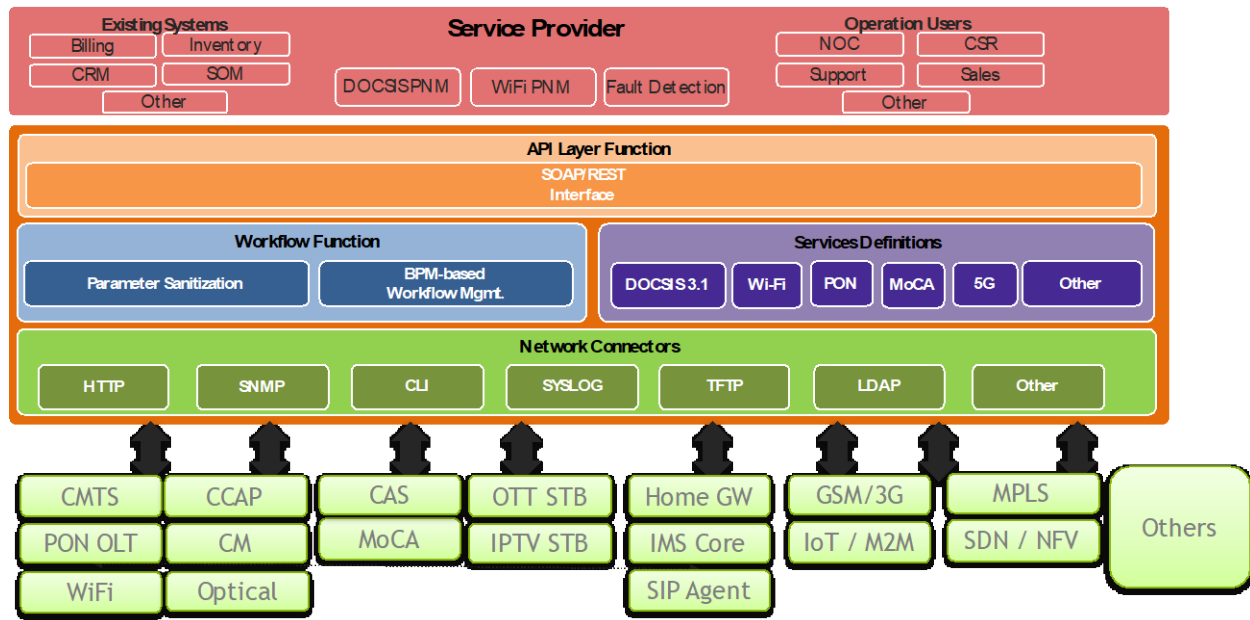

Figure 4 - Example of a Common Collection Layer Framework

The main benefits of having an abstraction layer in the data collection are:

- Flexibility in supporting as many network elements as desired independently of the monitoring protocol.
- Ability to cache data and so not duplicate request to network elements.
- Unique Northbound REST interface for the applications.
- Ability to orchestrate complex multi-element network data requests and consolidate the info in a single response.
- Increased security given that the policies for accessing the network data can be defined in a centralized manner.

4. Putting all Together

In the previous chapters, we have analyzed the key components for SDR and big data-based leakage detection, so now a use case for both technologies is presented in figure 5.

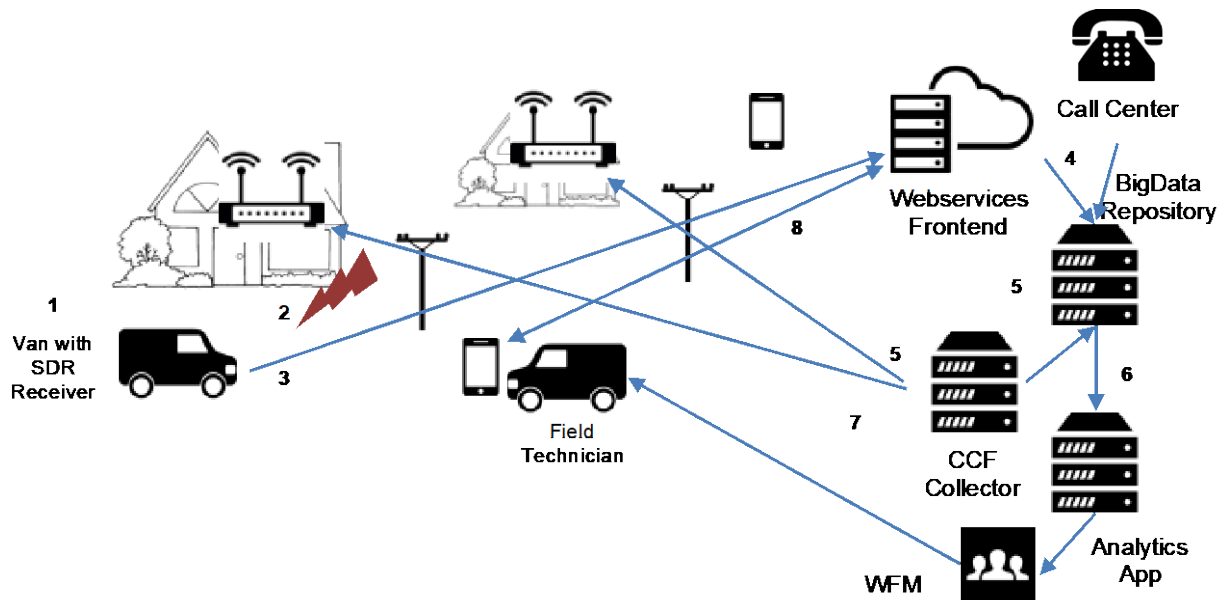

Figure 5 - Predicitve/Corrective Use Case using SDR Supplied Data

- 1) In this case, an autonomous SDR box is installed in the MSO or utility company trucks, or even in garbage collection trucks as is sometimes done currently. This box is continuously capturing RF data in a set of predefined bands which can be ultra high frequency (UHF, 700 MHz) or UHF+very high frequency (VHF) and using a combination of the both methods described previously (leakage detection using test signal phase and wideband spectrum capture with signature matching). This data is uploaded to a centralized big data repository together with the geographical position at periodic intervals.
- 2) Network data such from different sources such as CM, CMTS, CCAP is obtained at defined intervals though the common collector and mined into the repository. An example of typical data is shown in table 1.

Table 1 - Predictive/Corrective Use Case Network Data

DOCSIS	Downstream Spectrum Capture
DOCSIS 3.0	Downstream Channels RX Level
DOCSIS 3.0	Downstream Channels RX MER
DOCSIS 3.0	Downstream Channels CER
DOCSIS 3.0	Downstream Channels CCER
DOCSIS 3.1	Downstream Channels OFDM Subcarrier Rx MER
DOCSIS 3.1	Downstream Channels OFDM Subcarrier Channel Estimation Coeff
DOCSIS 3.1	Downstream Channels OFDM Profile FEC
DOCSIS	Upstream Spectrum Capture
DOCSIS 3.0	Upstream Channels RX MER
DOCSIS 3.0	Upstream Channels RX CER
DOCSIS 3.0	Upstream Channels RX CCER

DOCSIS 3.1	Upstream Channels OFDMA Subcarrier Rx MER
DOCSIS 3.1	Upstream Channels OFDMA Subcarrier Rx MER per CM
DOCSIS 3.1	Upstream Channels OFDMA Subcarrier Rx MER Pre Equalization

- 3) Data from other business sources such as call center trouble tickets and truck rolls and active equipment topology is also inserted in the repository
- 4) An analytics app with a correlation engine with machine learning algorithms is run through the selected data of interest from the dataset. In our tests, we have tried kernel-based online anomaly detection (KOAD) and one-class neighbor machine (OCNM) algorithms with different results and success rates which will be discussed in an upcoming paper.
- 5) The analytics engine detects predictive and corrective problem candidates and creates a ticket in the field or workforce management system, with all the supporting information that drove the algorithm to the identification of the problem such as, SDR leakage detection drive information (Figure 6), cable modem downstream RX level, MER alarms and downstream spectrum (Figure 7) captures of modems in the affected area.
- 6) An interesting case of data correlation is the case to detect and correct video related issues by the correlation with spectrum captures with channel lineups as show in Figure 8.

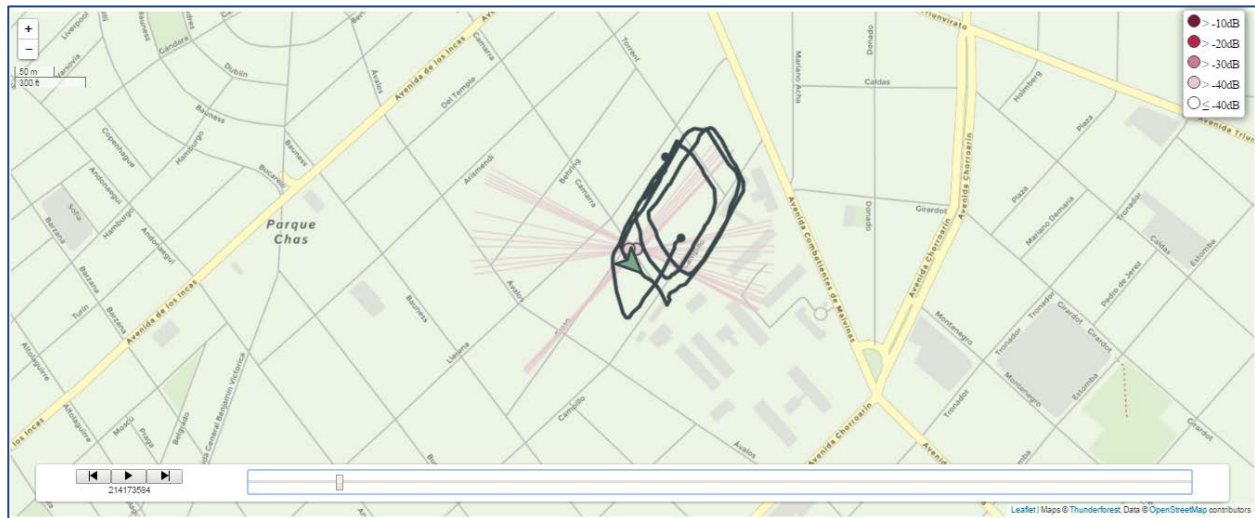

Figure 6 - SDR Based RF Leakage Detection Visualization

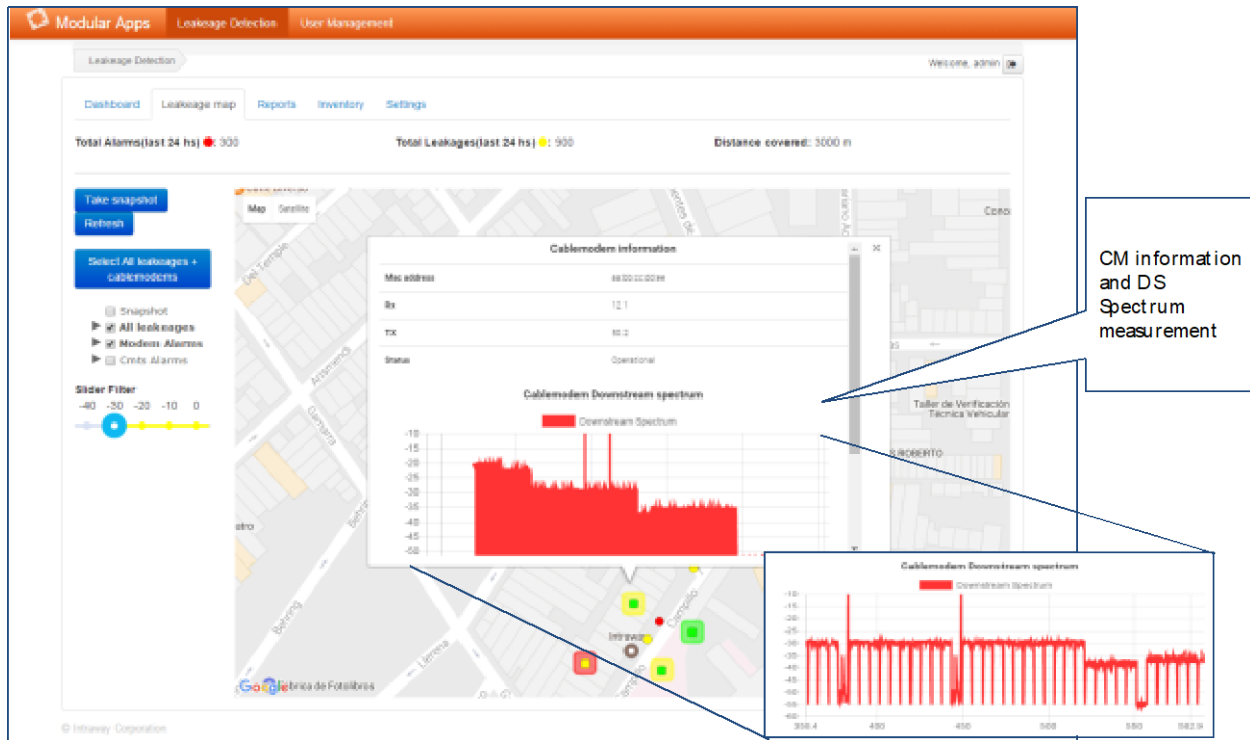

Figure 7 - Affected Cable Modem Downstream Spectrum Visualization

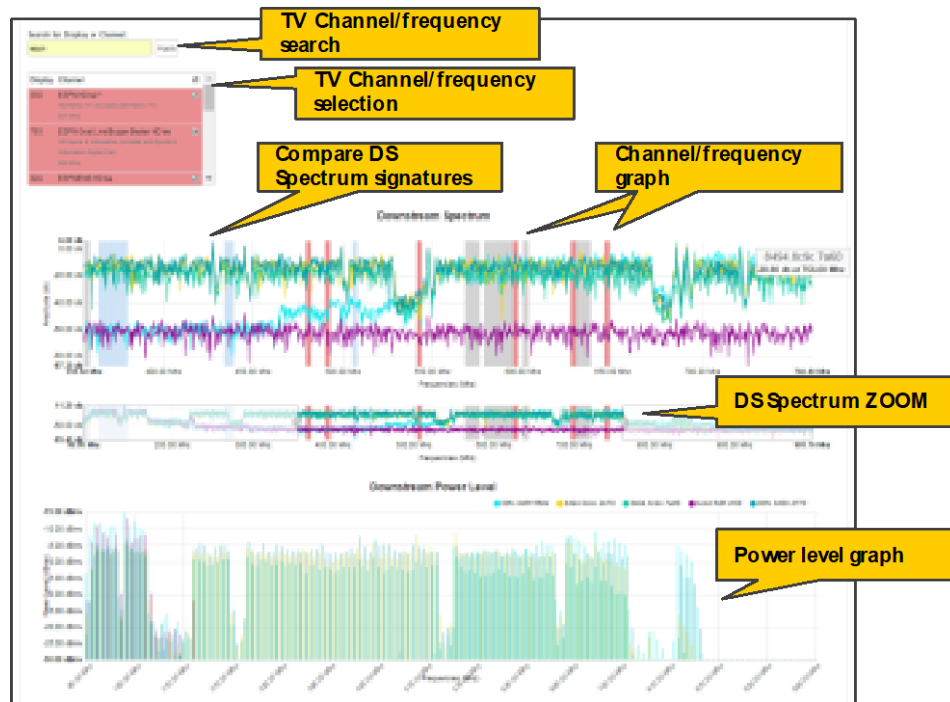

Figure 8 - Visualization of Downstream Spectrum to Channel Map for Video Issues

5. Conclusions

This paper analyzed some emerging technologies such as software defined radio and big data and showed they are ready to assist in the service assurance function of cable networks, particularly when coupled with the exponential growth in data availability from the network elements such as CMTSS, CCAPs and cable modems and also with other operation support systems.

It is also a goal of this paper to demonstrate the need to have a well-planned and modular data collection, storage and analysis strategy in order to be ready to support the higher orders of data processing capabilities required in the upcoming years, particularly when the service assurance function becomes an integral part of the whole lifecycle of a service.

6. Bibliography

- [1] - Leakage Detection Using Test Signal Phase with GPS - Tom Williams and Colin Justis -Cable Television Laboratories, Inc. – 2016 Technical Spring Forum Proceedings
- [2] - Another Look at Signal Leakage – The Need to Monitor at Low and High Frequencies by Ron Hranac and Greg Tresness, 2012 SCTE Cable-Tec Expo
- [3] - Big Data Analytics Guidebook - Frameworx Best Practice - Release 16.5.1 June 2017
- [4] - H. Hajji, Statistical analysis of network traffic for adaptive faults detection, IEEE Trans. Neural Networks, vol. 16, no. 5, pp. 1053-1063, Sep. 2005.

7. Abbreviations & Acronyms

ADC	Analog to digital converter
AGC	Automatic gain control
API	Application programming interface
CCAP	Converged cable access platform
CCER	Correctable codeword error ratio
CER	Codeword error ratio
CLI	Command line interface
CM	Cable modem
CMTS	Cable modem termination system
COTS	Commercial off the shelf
CSP	Communication service provider
CW	Continuous wave
DOCSIS	Data over cable service interface specification
FFT	Fast Fourier transform
FPGA	Field programmable gate array
GPS	Global positioning system
IoT	Internet of Things
IPDR	IP detail record
LTE	Long term evolution
LoRaWAN	Long Range Wide Area Network
MER	Modulation error ratio
MSO	Multiple service operator
MSpS	Mega samples per second
NB-IOT	Narrowband – Internet of Things

OFDM	Orthogonal frequency division multiplexing
PAPR	Peak to average power ratio
PCB	Printed circuit board
Ppb	Parts per billion
REST	Representational state transfer
RF	Radio frequency
SDR	Software-defined radio
SNMP	Simple network management protocol
STB	Set top box
TFTP	Trivial file transfer protocol
UHF	Ultra high frequency
VHF	Very high frequency
WiFi	Wireless fidelity

THE MoCA® PNM PARADIGM SHIFT

A Technical Paper prepared for SCTE•ISBE by

Rob Thompson,
Director of Network Architecture, Comcast, MoCA Board Member, and SCTE Member
One Comcast Center
Philadelphia, PA 19103-2838
robert_thompson@cable.comcast.com
(215) 286-7378

Maurice Manuel Garcia, Sr Principal Engineer, Comcast, SCTE Member
650 Centerton Road
Mount Laurel, NJ
maurice_garcia@cable.comcast.com

Abstract

Cable operators have benefited greatly from proactive network maintenance (PNM). Some of those benefits have included remote localization of impairments and aggregation of performance data via customer deployed devices, rather than dedicated test instrumentation. Another advantage has been the real-time feedback to technicians while working to mitigate impairments disrupting revenue-generating services. Up until now, making DOCSIS-based services work better has been one of the driving forces behind the development of a solid PNM infrastructure and knowledge-base.

For years, PNM experts have been pondering the potential of incorporating PNM strategies and concepts into other technologies, like the home networking technologies developed by the Multimedia over Coax Alliance (MoCA). Fortunately, DOCSIS has served cable operators very well, solving many problems facing cable networks today. However, cable operators are learning that issues facing MoCA deployments aren't easily diagnosed via the DOCSIS PNM. For example, current generation MoCA PNM can identify whether there's an incompatible splitter or drop amplifier within the customer's home network, which is introducing too much loss in the MoCA band of operation. And because MoCA is a mesh technology, it may be more effective in honing in on precise locations of home network defects impacting performance, like damaged cables or loose connectors.

This paper will define the use-cases that would be exclusive to MoCA PNM and present these proof-of-concept diagnostics, along with test results illustrating their effectiveness. There is much to learn with blending PNM concepts with mesh-based network topologies and MoCA is just one such technology to be mastered, and in doing so, the stage will be set to launch a similar effort enabling diagnostics for Wi-Fi® standards as well.

Table of Contents

Title	Page Number
Abstract	35
Table of Contents	36
1. Introduction	38
2. MoCA Telemetry Options	38
3. Remote Diagnostics Leveraging Cable Operator Product Deployment Statistics	39
4. Detecting Devices That Are Incompatible To MoCA Signaling	43
5. Sample Data Via Alternative Channel Assessment (ACA)	48
5.1. General ACA Retrieval Process	49
5.2. Processing The ACA EVM Probe Data	50
5.3. Normalizing The EVM Probe Data	51
6. Detecting Missing Point-Of-Entry (POE) Filters	55
7. Tilt Detection	58
8. CW Detection	60
9. New service assessment, Midsplit Self Install Kits (SIK)	61
10. Conclusions	63
11. Acknowledgements	63
12. Abbreviations And Definitions	63
13. Appendix	64
14. Bibliography And References	64

List of Figures

Title	Page Number
Figure 1 - Creating CCDF From Statistical Data	41
Figure 2 - KPI CCDF Example	42
Figure 3 - OP2OP Isolation Of MoCA Exd OFDM Beacon Signals From D1 Thru D10	44
Figure 4 - MoCA Network Diagram Illustrating Splitter Jumping	45
Figure 5 - Preference For Home-Run (Left) Over Loop-Through (Right) Home Network Topology	46
Figure 6 - Compatible Drop Amplifier And Splitter CCDF	47
Figure 7 - Incompatible Drop Amplifier And Splitter CCDF	48
Figure 8 - 4-Way NMFS Home Network Configuration	49
Figure 9 - General ACA Retrieval Process	50
Figure 10 - ACA EVM Probe (Not-Normalized)	51
Figure 11 - ACA EVM Probe (Normalized)	53
Figure 12 - MoCA-1 PTP EVM Probe Overlay To MoCA-2, 3 And 4	53
Figure 13 - MoCA-2 PTP EVM Probe Overlay To MoCA-1, 3 And 4	54

Figure 14 - MoCA-3 PTP EVM Probe Overlay To MoCA-1, 2 And 4	54
Figure 15 - MoCA-4 PTP EVM Probe Overlay To MoCA-1, 2 And 3	54
Figure 16 - PTP EVM Probe Showing HPF Edge	55
Figure 17 - POE Filter Installation Example	55
Figure 18 - 4-Way Non-MoCA Friendly Splitter With 25' POE 75Ω Terminated	57
Figure 19 - EVM Probe PTP Viewpoint With/Without POE	57
Figure 20 - MoCA Communication Paths With A POE Filter Present	59
Figure 21 - MoCA Tilt Assessment Against Correctly Installed POE Filter Population Threshold	60
Figure 22 - Expected Passband Responses, No POE Filter Present	61

List of Tables

Title	Page Number
Table 1 - Full Mesh Rate (FMR) Mbps PHY Rate	39

1. Introduction

Today's diagnostic systems are challenged to effectively identify and isolate home network defects specifically impacting the home network performance. These defects include incompatible drop amplifiers and splitters, and missing point-of-entry (POE) filters.

For the most part, access networks and home networks have operated on mutually exclusive frequency bands. Access network service space has traversed both the access and home network to deliver voice, video, and high speed data from a centralized hub to devices deep within the home via transport technologies, such as DOCSIS. Home network services on the other hand, ideally operate within the home between multiple customer premises equipment (CPE) in support of services including, any room digital video recorder (DVR), or Wi-Fi extension.

Today's DOCSIS-based, PNM solutions have helped us detect many problems. Since DOCSIS is a point-to-multipoint (PTMP) network topology, it is capable of detecting problems located within the communication path between the cable modem termination system (CMTS) and its associated cable modems (CM). In particular, current PNM solutions have been very strong for detecting defective components associated with micro-reflections or echoes in the access and home networks. However, DOCSIS-based PNM has been challenged to detect splitters and drop amplifiers that impair MoCA as well as missing POE filters. The basis for this will become apparent within the next few paragraphs.

One of the main reasons DOCSIS-based PNM is incapable of diagnosing incompatible splitters, and drop amplifiers, along with missing POE filters is because the traditional access and home network operating bands are mutually exclusive frequency spaces. Readers may be happy to know that the spectral boundaries previously separating these technologies will begin to blur in the newer generations of DOCSIS 3.1 (D3.1) and MoCA.

Some overlap in these bands may already exist as cable operators continue to upgrade their networks to support D3.1 deployments, with its required operating bands extending above 1,002 MHz and up to 1,218 MHz. It is anticipated that the newer generation of MoCA will operate well below 1,002 MHz in order to support higher capacity. Currently, the spectrum overlap between 1,125 and 1,218 MHz will represent approximately 17% of the MoCA Extended D (ExD) band, where the remaining 83% of the band will unfortunately not be visible to newer D3.1 devices, even with meeting mandatory requirements. In addition to limited frequency overlap, DOCSIS PTMP based diagnostics can only characterize a subset of the communication paths that exist in the home, because there are home network devices that are MoCA only, i.e. Wi-Fi/MoCA extenders. This uniquely positions MoCA, which is a multipoint-to-multipoint (MPTMP) mesh technology to more comprehensively characterize the home network because it has the visibility of the coaxial home network operating bands and MPTMP CPE. This capability of coordinating with one another will provide bidirectional diagnostic information associated with MoCA-based CPE.

This paper will investigate prospects of diagnostic solutions for detecting excessive path loss, a trait associated with incompatible splitters and drop amplifiers, as well as a system for detecting missing POE filters. With these diagnostic processes in place, cable operators can benefit from reduced operating cost and time to repair, as well as improving the customer experience, and use these new processes to complement and enhance the strong suite of capabilities already provided by DOCSIS-based PNM.

2. MoCA Telemetry Options

MoCA diagnostic solutions are at a state where DOCSIS diagnostics were almost a decade ago. Much of the diagnostic feedback related to MoCA is in the form of physical layer throughput, and unfortunately it is too coarse to provide root cause identification of network components contributing to a service disruption. For example, today's MoCA 1.1 home network diagnostics primarily leverage full mesh rate (FMR) table, which represents throughput capabilities between all mesh devices, see Table 1.

Node	1	2	3
1	-	201	208
2	149	-	270
3	213	205	-

Table 1 - Full Mesh Rate (FMR) Mbps PHY Rate

This information is available via the MoCA 1.1 simple network management protocol (SNMP) management information base (MIB).

By inspecting the FMR table, rates that fail to meet some pre-defined threshold, for example 200 Mbps PHY Rate for MoCA 1.1, are flagged for further investigation by field installers, who are responsible for determining the cause of the failure. Failure to meet a threshold may be caused by a variety of defects including incompatible drop amplifiers, splitters, or missing POE filters. Unfortunately, FMR values alone do not diagnose and isolate defects. Today it is the field technician that must visually inspect or connect test equipment to the home network in order to identify and isolate potential root causes of the service degradation.

As was referenced previously, but worth repeating here as we dig into the details of a new PNM paradigm, mesh networks are uniquely positioned to provide comprehensive MPTMP home network characterization. This mesh-based characterization encompasses substantially more detail, specific to the home network, than any DOCSIS-based PTMP PNM solution can provide. Having MoCA PNM-like automation in the home network, field installers can be diverted to more pressing issues and do not require the visual inspection or connected test equipment to the home network in order to identify and isolate potential root causes of the service degradation.

3. Remote Diagnostics Leveraging Cable Operator Product Deployment Statistics

Before describing the processes by which we diagnose MoCA-only issues within the home network, we'll need a framework for deciding when and how to act with respect to new data coming from MoCA diagnostic channels. The good news is that the processes we are about to talk about are not new to our industry, or even to the engineering sciences in general. If anything, the approach we will describe here merely formalizes a decision-making approach the cable operator community has likely had in place for a long time.

This approach is analogous to processes that have long been in place for manufacturing industries to monitor, manage, and minimize defects across production lines. However, the key difference is that instead of capturing variation and statistics specifically associated with a particular manufacturing process, we intend to extend the statistics and variation to also capture deployment variation-specific data associated with making these products generally available to cable operator consumers. So what value would deployment data add to observed manufacturing statistics? The eternal optimist in us says the differences would be negligible.

Cable operators document their specifications well, accounting for all the consumer environmental conditions and capturing all the key performance indicators (KPIs) that matter. Manufacturers design and build products that meet those specifications and demonstrate compliance across all the cable operator defined environmental conditions. When everyone does their job well, the differences between manufactured and deployed product KPIs will indeed be negligible, even when the numbers

extend to cable operator footprints of millions of consumers. The realist in us says “that no matter how good plans are defined and executed, Murphy’s Law is ever present and there will always be surprises”. Essentially, there will always be moments when the designer says, “hmmm..., I didn’t see that coming, back to the drawing board.”

That’s what this approach is all about. Defining normal behavior based on statistics and variation, and thus creating the opportunity for us to easily recognize when we do well and when we do not do so well with respect to those established norms. We will examine KPI norms across large deployed populations, similar to how manufactures assess KPIs associated with new production runs.

We will use the complimentary cumulative distribution functions (CCDF), which are nothing more than a particular format or view of our large population KPI data. This statistical data format will assist us in intuitively understanding the statistical nature of new KPI data with respect to established norms, acknowledging that some amount of variation will always be present. When we do our jobs correctly, variation, however much is present, will ideally have a negligible impact on the end user experience.

The process of obtaining a CCDF curves are well understood and documented. In fact, most of us may already be familiar with histograms or bell curves used to describe statistical behavior over a population. Ever benefit from having a statistical curve applied to your final score in high school or college? The CCDF is essentially derived from the probability density function (PDF), which in non-normalized form is often called a histogram, illustrated in Figure 1. Histograms plot the frequency of KPI occurrence against the KPI values themselves. For large datasets tending toward the classic Gaussian distribution, commonly occurring KPIs cluster around the average KPI value, while the less commonly occurring KPI values end up in the tails of the bell curve, above, below, and further away from the average.

Aggregating or summing the relative frequency of occurrence of the KPIs from 0 to 1 is what leads to the cumulative distribution function (CDF). Taking the compliment of the CDF or subtracting the probability of any given KPI value from 1, $1-P(KPI)$, is what leads to the CCDF. The value of using CCDF versus a histogram, or a CDF really boils down to personal preference of assessing large datasets. The CCDF format is appealing because the majority of the population data is centered about the origin making dataset comparisons more palatable.

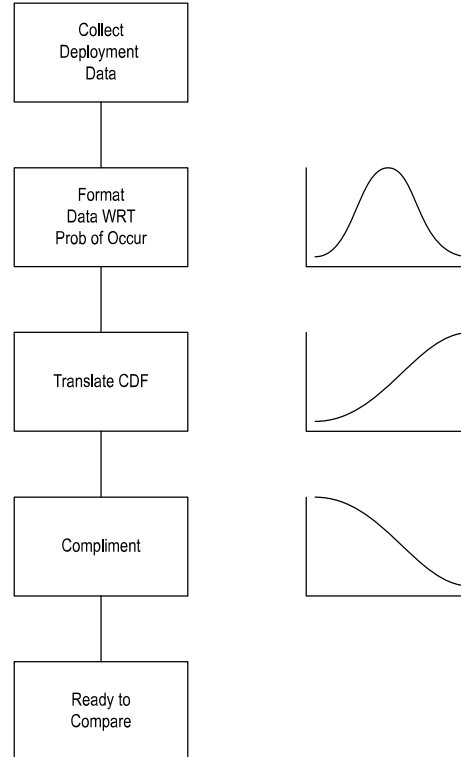

Figure 1 - Creating CCDF From Statistical Data

So with some CCDF background under our belts, let's now examine a generalized KPI CCDF example illustrated in Figure 2. The y-axis is reserved for probabilistic measure, with an origin at 0 probability, and its maximum at a probability value of 1 or 100%. KPIs very near the origin have a low likelihood of occurrence, while one can be assured of occurrence with KPIs near 100%. The horizontal, or x-axis is a little more flexible in that it can be any KPI of interest or measure of *goodness*. In our example, *goodness* improves for values further away from the origin, while values close to the origin are not so good. The directionality of *goodness* is chosen such the greatest areas of the CCDF curve are always near the origin, making it easier to make comparisons, as we will soon see.

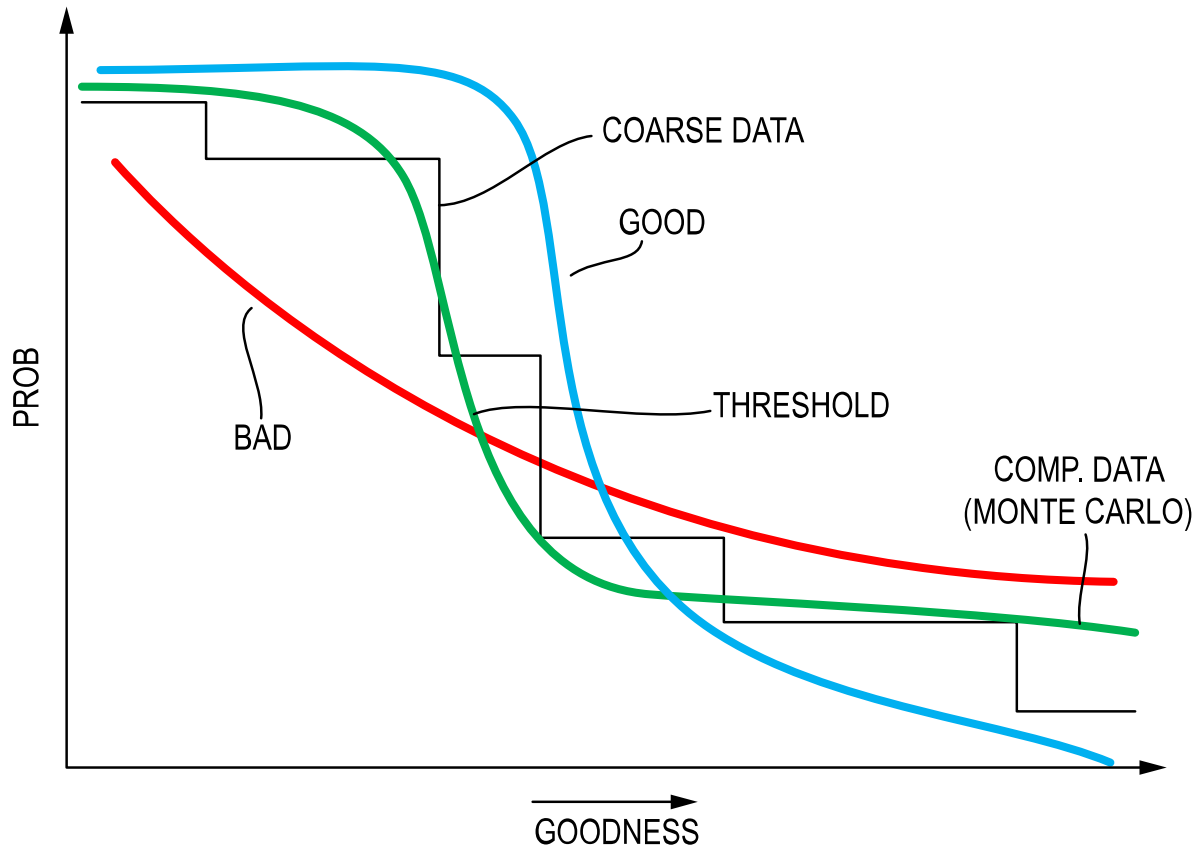

Figure 2 - KPI CCDF Example

The green curve, labeled “Threshold” in Figure 2, represents an example of a population norm. For example, this could be the aggregation of cable operator deployment data encompassing a specific KPI associated with an entire population of deployed products, like downstream receive SNR. Maybe the cable operator feels that this data is representative of the population in general, and therefore the curve can be established as a cable operator norm, setting expectations for average KPI performance and reliability, or variation. Low variation thresholds will result in mostly vertical CCDF curves, where the vertical line coincides with the population KPI and the variation will be minimal leading to small tails above and below the vertical KPI line. As an example, a sample cable modem (CM) signal to noise (SNR) population norm could be approximately 36 dB, with very small percentages (roughly 5%) being 2 dB above and below 36 dB. Additionally, 95% of the population SNR will be at least 36 dB.

If a cable operator wanted to introduce a newer generation cable modem, which would be represented by the “Blue” curve in Figure 2, leveraging the same SNR KPI. Comparing the newer generation cable modem SNR data is obviously better than the green because its average measure of goodness is higher and its variation of performance is equal or less. A right-shifted CCDF can be appropriately labeled as a “Good” CCDF, while a left-shifted CCDF can be considered bad, since their performance is worse for the majority of KPIs. The red curve, labeled “Bad”, also the same KPI, but maybe in this case represents an older generation cable modem technology deployment, whose average measure of goodness is lower and its variation of performance is higher when compared to threshold, essentially lower KPI and flatter curve overall.

As was noted previously, representing large datasets in this manner is not new, in fact many similar comparisons have been made previously by manufacturers comparing performance of new production runs to previously established factory production thresholds, or when standards organizations compare performance of different standard generations. A key thing to remember when using the CCDF is that unique cable operator information can be exploited, specifically aggregating statistical performance associated with various technology deployments, which may be difficult to reproduce in a laboratory environment. Armed with a fundamental understanding of the CCDF curve, we're now in a position to use these curves to make remote diagnostic decisions with respect to MoCA channel statistics and home network craftsmanship. The first use-case to examine will be in identifying excessive path loss that may be associated with drop amplifiers and splitters that are incompatible to MoCA.

4. Detecting Devices That Are Incompatible To MoCA Signaling

MoCA has been engineered to be an extremely robust home networking technology. For example, engineers knew that MoCA signals needed to be strong enough to jump across splitter ports, a path not originally conceived of when CATV networks were first designed. In fact, splitter jumping still is considered an undesirable network trait in access networks. So much so that the loss, called output-port-to-output-port (OP2OP) isolation is generally specified to be very high, for example 25 dB on many devices including taps, and passives. What's even more impressive is that MoCA can splitter jump at extremely high frequencies, remembering in the introduction where it was pointed out that the MoCA operating band was 1,125 to 1,675 MHz. At these frequencies, attenuation is generally much higher than what is experienced within the DOCSIS bands, not just for coaxial cable, but for splitters and drop amplifiers too.

Figure 3 illustrates the amount of attenuation a MoCA channel can experience. In Figure 3, the spectrum analyzer was set on max-hold from 1GHz to 1.7GHz. We instructed the MoCA endpoints to link up on D-Channels D1 – D10. The response you see is the summation of MoCA beacon which is used to establish a MoCA Network Link.



Figure 3 - OP2OP Isolation Of MoCA Exd OFDM Beacon Signals From D1 Thru D10

Another complication is that many legacy splitters and drop amplifiers that have been installed in consumers' homes that don't support frequencies above 1 GHz. Therefore, these bands can have what are called "suckouts" or small bands of frequencies which have extremely high loss. To make matters worse, suckouts can occur at random frequency locations and for random port combinations. Again, MoCA engineers are aware of this, so they engineered MoCA to be capable of working around suckouts. Since its inception (MoCA 1.1 was created in April 5th, 2011), the MoCA protocol has been intelligent enough to detect suckouts and form networks around them. Figure 4, from [1], illustrates MoCA's splitter jumping capability.

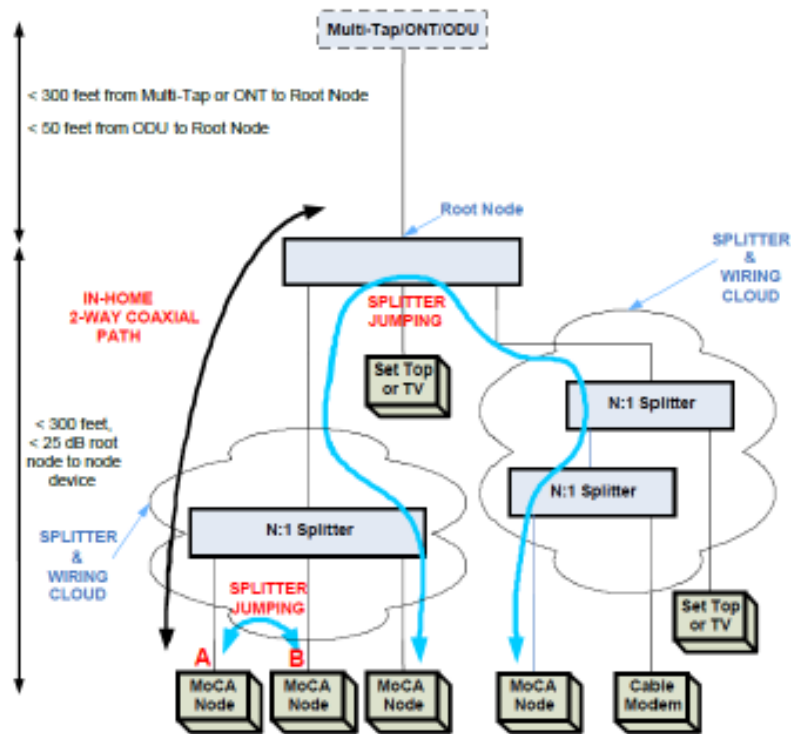

Figure 4 - MoCA Network Diagram Illustrating Splitter Jumping

Deployment of MoCA has led cable operators to converge upon a much simpler network model. As was discussed previously, cable operators deploy MoCA with a target capacity of at least 200 Mbps to support services like any room DVR. Cable operators have been able to achieve this at scale, but with a much simpler home networking approach. First, MoCA's operating center frequency may be constrained, or limited to the lowest operating center frequency or 1,150 MHz for MoCA 1.1. Second, loop through, or cascaded splitter networks illustrated in Figure 4 and the right side of Figure 5 have been traded for home-run networks illustrated on the left side of Figure 5. Home networking topology Figure 4 and Figure 5 were recently introduced in an SCTE operational practices document, see [1] for details.

These simplifications, which optimize home networking path loss, have enabled cable operators to meet throughput performance targets more easily. Unfortunately, networks are not static, and as service targets advance toward achieving higher capacity using more bandwidth, cable operators will need help in identifying when path loss challenges arise for those new bandwidth requirements. Fortunately, there is an approach for remotely diagnosing of when path loss may become objectionable and its basis is in exploiting what MoCA has been capable of since it was originally conceived.

In April of 2017, MoCA created the MoCA 2.0 SNMP MIB for its membership, and with it making available the home network probing technology it uses to learn about channel suckouts or more generally, channel path loss. This information is now available to cable operators to remotely poll MoCA 2.0 capable devices and learn whether excessive path loss, i.e. suckouts, exist within any given MoCA deployment. In fact, anything that would negatively impact MoCA path loss and ultimately throughput performance is now accessible to cable operators to see.

Armed with this knowledge, cable operator can make decisions about how best to deploy higher capacity home networking services, like 1 Gbps high-speed data service. The approach we describe differentiates between compatible versus incompatible devices within the home network space. A large percentage of home networks use splitters to distribute both access network and home networks signals throughout the home. A smaller percentage of home networks will use drop amplifiers, active

components to incrementally reduce path loss within the home network. The process we will describe will be agnostic to both types of components and will simply detect when and where objectionable amounts of path loss exists.

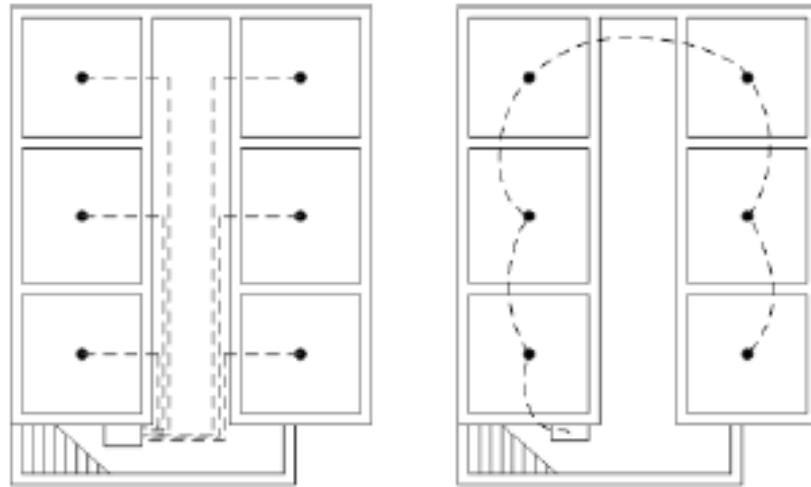

Figure 5 - Preference For Home-Run (Left) Over Loop-Through (Right) Home Network Topology

Remembering the CCDF from earlier, we'd now like to discuss a statistical threshold for compatible splitters and drop amplifiers. Cable operators could collaborate with their vendor partners to create a statistical description or CCDF of OP2OP isolation performance for all compatible splitters and drop amplifiers illustrated in Figure 6. The average or mean of the compatible splitter or drop amplifier OP2OP isolation, labeled μ_{COMP} , could be a value of 25 dB, whereas 99.9% (Figure 6 non-shaded area) of the devices measured could have an OP2OP isolation better than 30 dB. It's also important to note that there will be a certain degree of variation or reliability required, which is described as standard deviation, labeled σ_{COMP} .

Maybe an acceptable value for standard deviation would be ± 1 dB, or 24-26 dB about the mean. Lastly, a very small percentage of the population 0.1% (Figure 6 shaded area) could have OP2OP isolation values greater than 30 dB. Armed with our statistical description, we could use this data as a starting point to help us decide between compatible versus incompatible splitters and drop amplifiers. We could also poll a population of deployed MoCA devices that are performing well and obtain an ideally similar, but perhaps slightly different set of statistics. The point is that whatever our threshold is, it is based on solid data associated with a favorable end user home networking experience.

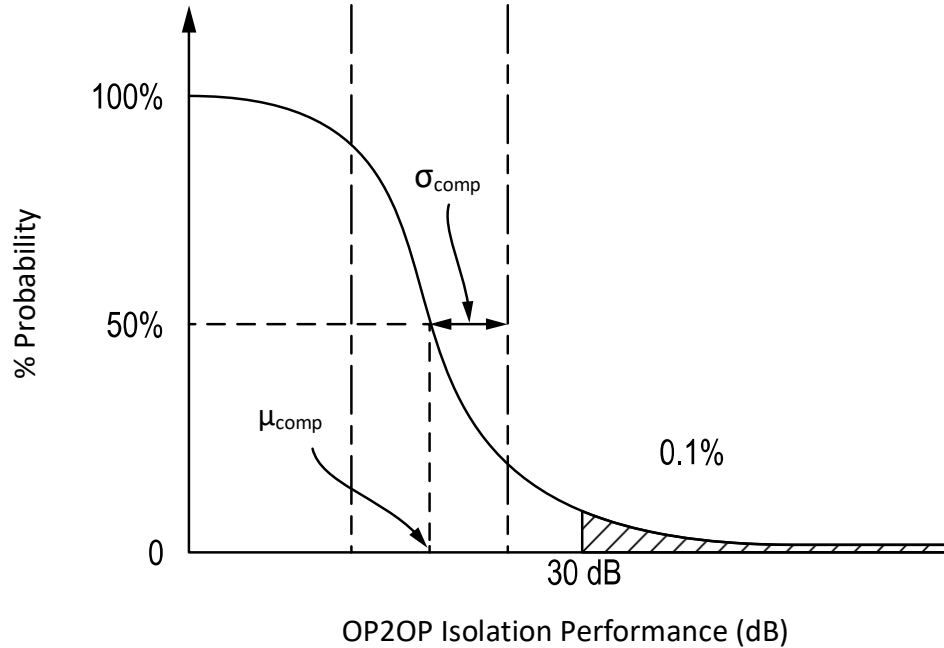

Figure 6 - Compatible Drop Amplifier And Splitter CCDF

When trying to differentiate incompatible drop amplifiers and splitters that appreciably degrade the end-use experience, comparisons of any new data will be made against established thresholds. The new data can come from a home network where the end user has logged a ticket, citing unfavorable home networking experience. All of the MoCA 2.0 capable devices could be polled for estimates of path loss to all of the other MoCA 2.0 capable devices participating in that particular home network.

The data can be aggregated into a CCDF curve for comparison to the established threshold. Cases where both the newly measured mean and standard deviation of the OP2OP isolation performance are appreciably worse than the established threshold can implicate objectionable path loss and possibly OP2OP isolation as a potential root cause, thus flagging that home network for remediation. Figure 7 illustrates such a case where it can easily be seen, via the red curve, that both the mean and standard deviation are appreciably worse than the desired threshold, which is illustrated via the black CCDF curve.

Also notice how the red, incompatible CCDF, curve flattens out and shifts right, indicating higher standard deviation (reduced reliability) and higher loss values. An excessive path loss alarm can be shared with the installer, prior to arriving at the home, guiding the installer to investigate whether incompatible splitter or drop amplifier exists within the home network. Upon replacement of the incompatible device with a compatible one, immediate feedback can be provided to the installer on whether path loss falls below threshold or if the path loss problem persists.

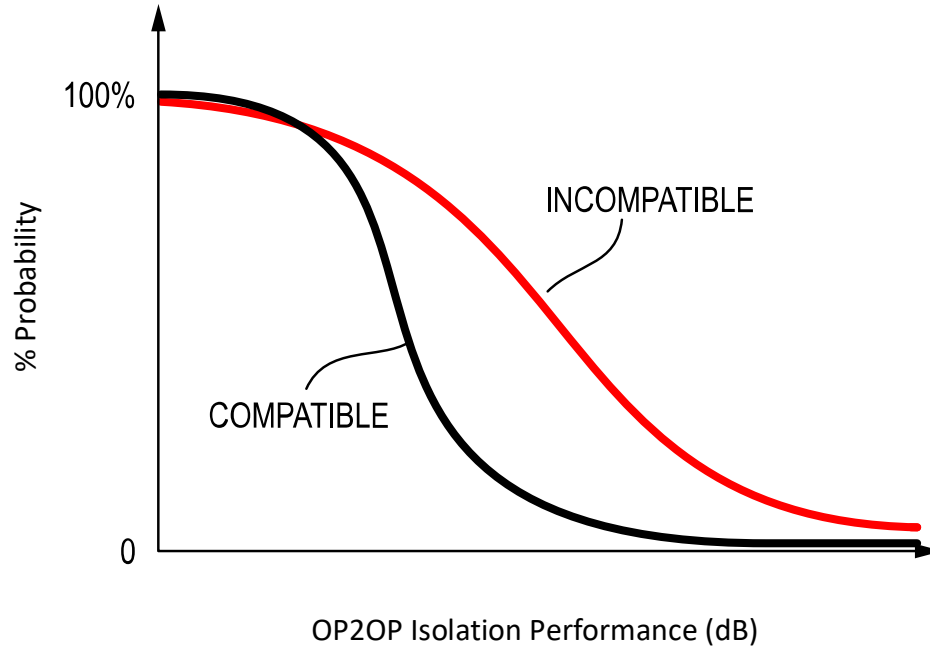

Figure 7 - Incompatible Drop Amplifier And Splitter CCDF

What has been demonstrated is a process for establishing thresholds for acceptable home networking path loss and a general statistical-based method of indicating when path loss thresholds are not being met. One of the leading causes of objectionable path loss today is suckouts from incompatible home splitters and drop amplifiers. Perhaps a process similar to what has been described here may be exploited by cable operators wishing to leverage higher bandwidth service that require MoCA technology, and remotely isolate and identify some of the legacy home network components that may no longer be compatible in reaching that goal.

5. Sample Data Via Alternative Channel Assessment (ACA)

Previous references reviewed how MoCA is designed to be a robust protocol. Unlike in D3.1, where its signals are required to have as close to a flat OFDM spectral response as possible, MoCA can have areas of the occupied OFDM spectrum that are highly attenuated. Unfortunately, this robustness comes with a cost of lower subcarrier modulations, which in turn can potentially lower the PHY/MAC rate link. Cable operators are migrating to MoCA-friendly splitters (MFS) and MoCA-friendly drop amplifiers (MFDA), but at an additional cost per unit. This upgrade to the MFS is reserved for customers that “MAY” have physical (PHY) layer issues. With the new MoCA 2.0 ACA feature, we have a better view of the characteristics of the OP2OP isolation. This provides another option in the PNM tool kit to assist the customer account executive (CAE) or field technician in determining why the customer is experiencing a PHY layer or an IP/Network connectivity issue.

The following section details the retrieval and processing of the ACA data. Due to the process of how the ACA is determined in the MoCA specification, the user needs to add a correction factor so that the ACA response is analogous to a spectrum analyzer.

The following example is a 4-way non-MoCA-friendly splitter (NMFS), where the ExD MoCA channel frequency response is not a flat spectral response.

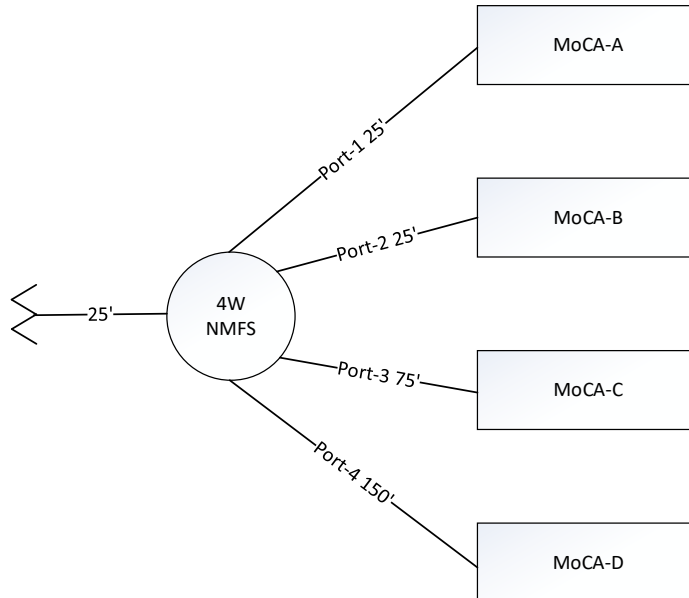

Figure 8 - 4-Way NMFS Home Network Configuration

5.1. General ACA Retrieval Process

This section briefly describes the process of retrieving the ACA error vector magnitude (EVM) probe data. It is assumed that in a mesh environment, the user will need to perform the ACA EVM probe to each of the MoCA-enabled devices. Optionally to save time, users may ignore the reverse EVM probe path, but it is recommended that the reverse ACA EVM probe be performed for detecting path loss asymmetry, which is a condition associated with older generation, non-MoCA-friendly drop amplifiers, specifically when using VoIP/passive port connections. Reverse ACA EVM probes, in general, are a good idea to avoid any surprises and to have a more precise average of the path loss since there may likely be differences among the bidirectional paths.

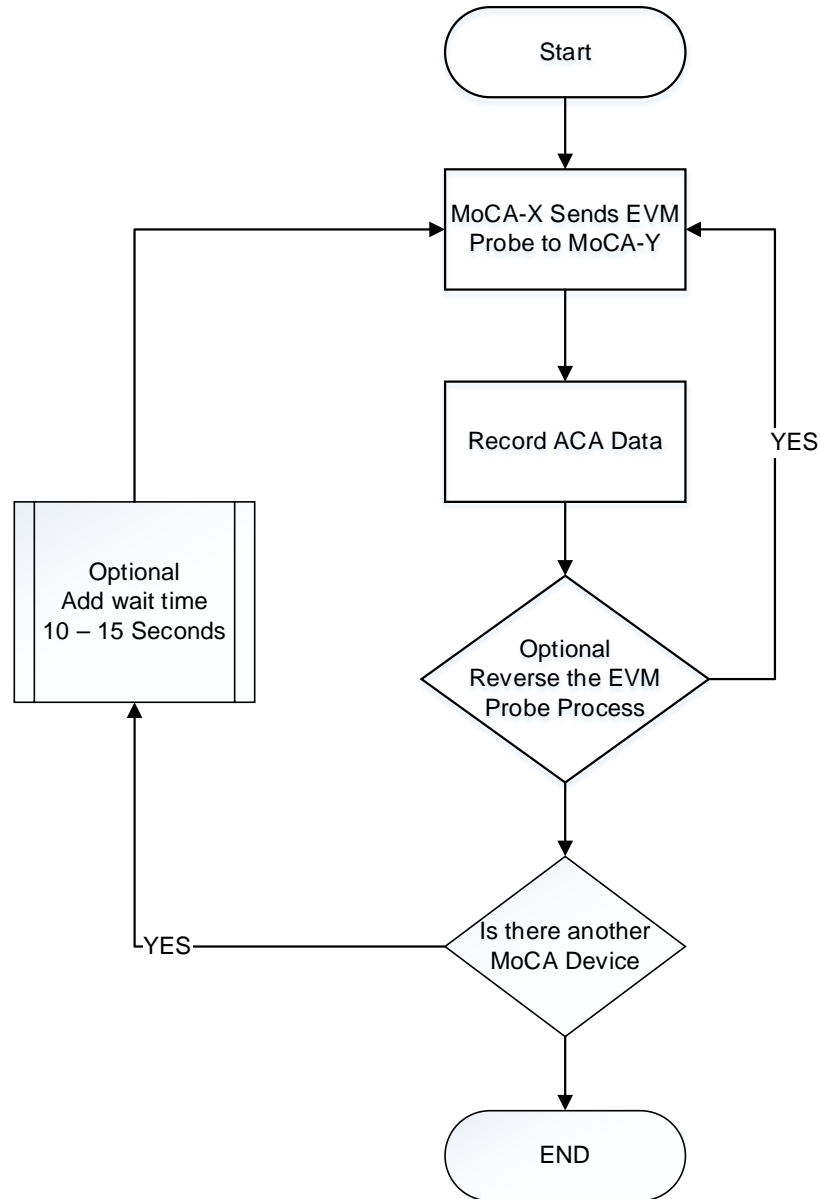

Figure 9 - General ACA Retrieval Process

5.2. Processing The ACA EVM Probe Data

The ACA EVM probe operation discussed in this section, is the process of applying a correction factor to achieve a spectrum analyzer analogue.

When initiating an EVM Probe between two MoCA endpoints, this requires that the MoCA network is quiet, with the exception of the two MoCA devices that are being evaluated. Typically you assign a MoCA endpoint to send an EVM Probe to a destination. In this example, we are performing an EVM Probe from Channel D1 through D10, but skipping the odd D-Channels: D3, D5, D7 and D9 so that we

do not have overlapping spectrum. This is done for convenience only. The user can implement overlapping spectrum, but keep in mind when graphing, averaging is needed for the two overlapping dBm points on the same subcarrier.

5.3. Normalizing The EVM Probe Data

To get a better representation of the actual OP2OP isolation we will need to perform a correction of the EVM probe data. In this example the system on a chip (SoC) implementation performs an AGC of the receive EVM probe. When graphing the power levels over frequency Figure 10, it would appear to be a flatter response, with possible oscillation, or ripples across the OFDMs. This interpretation would be incorrect, as this is not what is actually happening on the wire. To understand the actual response, the user will need to perform a correction of the EVM probe data.

Normalization requires two pieces of information:

1. ***mocalfAcaTotalRxPower***
 - a. This is the actual measured 100 MHz receive power in dBm, including OFDM guard bands at the F-Connector
2. ***mocalfAcaPowerProfile***
 - a. This is the per-subcarrier processed receive EVM in dBm.

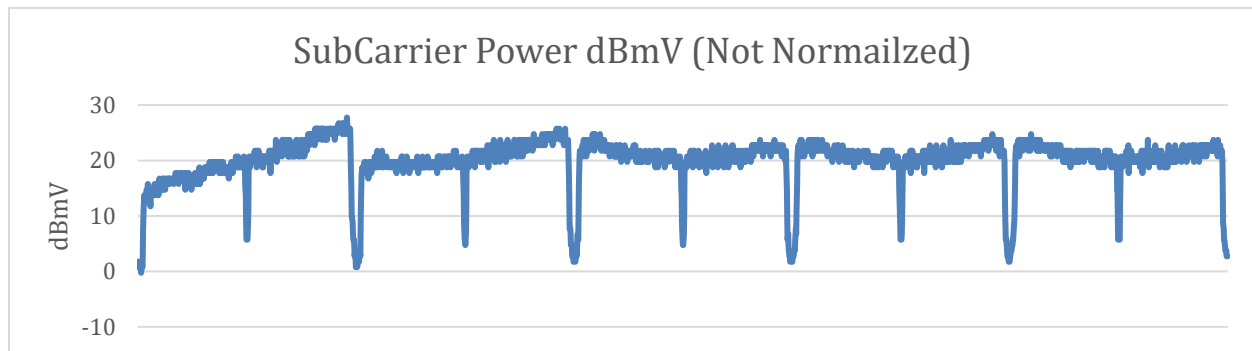

Figure 10 - ACA EVM Probe (Not-Normalized)

Figure 10 represents the non-normalized EVM probe response. The normalization of the EVM probe is an easy process. The following provide the mathematical equations to perform the normalization operation, involving three steps.

5.3.1. Step 1 – Integration Of The EVM Probe Per-Subcarrier Power

Integrate the ACA power profile OFDM subcarrier dBm EVM measurement to calculate its total channel power, using Equation 1 and defined variables for EVM_{Bin} and EVM_{CPALC}

EVM_{Bin}

= The stored array of EVM Probe dBm levels from index $SubCarrier_0$ to index $SubCarrier_{N-1}$

EVM_{CPALC} in dBm = The Total Channel Power calculated from the EVM Probe Data

Equation 1: Total Channel Power Equation

$$EVM_{CPCalc}dBm = 10 * \log_{10} \left(\sum_{n=0}^{EVMBin.size-1} \left[10^{\frac{EVMBin(n)}{10}} \right] \right)$$

5.3.2. Step 2 – Calculating MoCA Channel Correction Offset

Calculate the correction offset

if $EVM_{CPCalc}dBm < ACATotalRxPower$

$$EVM_{Offset} = |EVM_{CPCalc}dBm + ACATotalRxPower \text{ dBm}|$$

else if $EVM_{CPCalc}dBm > ACATotalRxPower$

$$EVM_{Offset}dBm = |EVM_{CPCalc}dBm - ACATotalRxPower \text{ dBm}|$$

5.3.3. Step 3 – Normalizing MoCA Channel

Apply the correction offset to normalize the EVM Probe Data

Iterate all subcarriers, i = 0..N

$$EVMBin_{Correction}(i) = EVMBin(i) + EVM_{Offset} \text{ dBm}$$

Since all results are in dBm, it will need to be converted to provide dBmV value:

Equation 2: dBm to dBmV Conversion

$$dBmV = 10 * \text{Log}_{10} \left(\frac{75\Omega}{1 * 10^{-3}} \right) + dBm$$

Figure 11 represents the revised EVM probe with a normalized response. Comparing Figure 10 with Figure 11 clearly illustrates the need for normalization when attempting to learn about the effects of the MoCA RF communication channel. This particular MoCA communication channel appears to be dominated by OP2OP isolation, since there appears to be significant reverse tilt across the MoCA band. Reverse tilt illustrated in Figure 11 isn't enough to diagnose incompatible splitters, since vendors are capable of applying processing needed to compensate for the tilting effects typically observed in OP2OP isolation profiles.

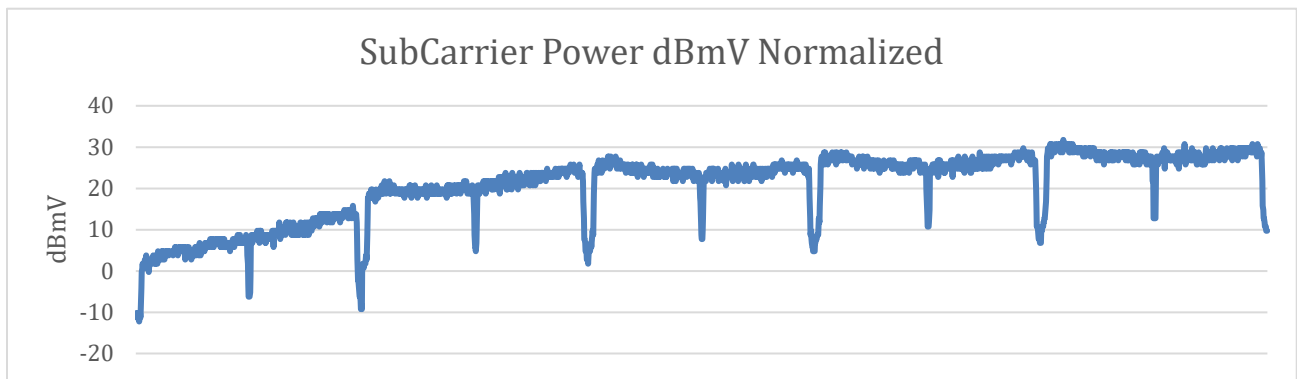

Figure 11 - ACA EVM Probe (Normalized)

The next four figures represent the PTP EVM probe normalized responses. As you can see, although this would be considered an incompatible splitter for MoCA because it does not include support for the band of operation, it does provide some flatness after starting with D1 across all port combinations.

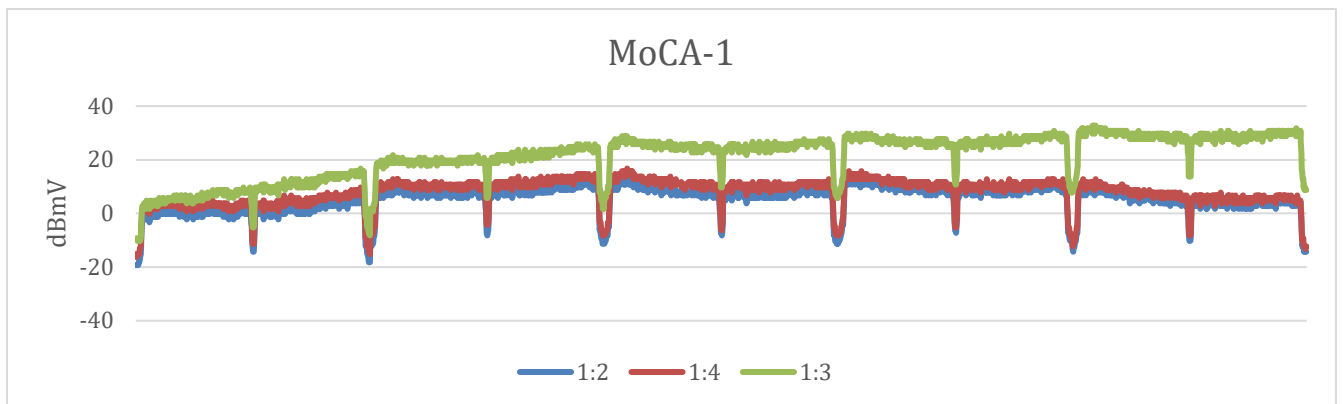

Figure 12 - MoCA-1 PTP EVM Probe Overlay To MoCA-2, 3 And 4

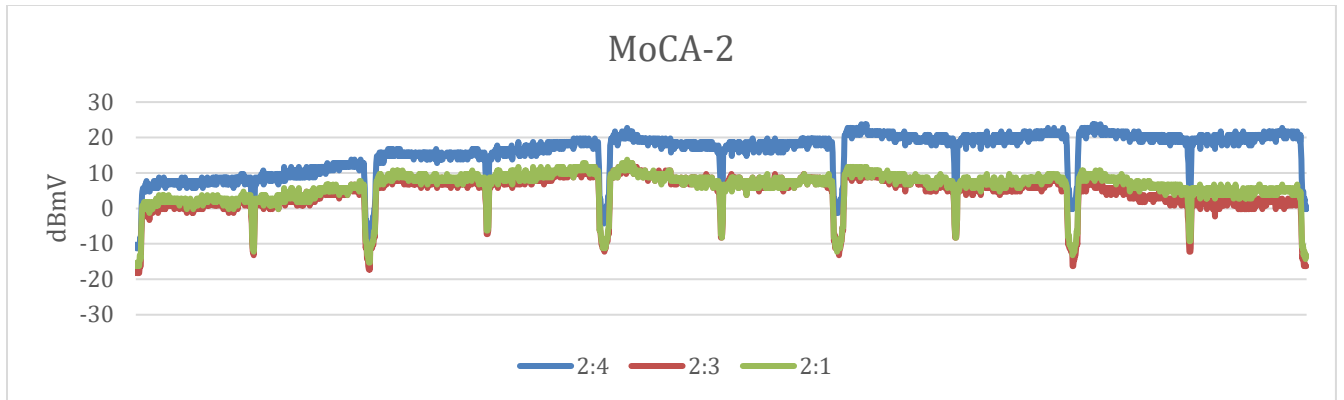

Figure 13 - MoCA-2 PTP EVM Probe Overlay To MoCA-1, 3 And 4

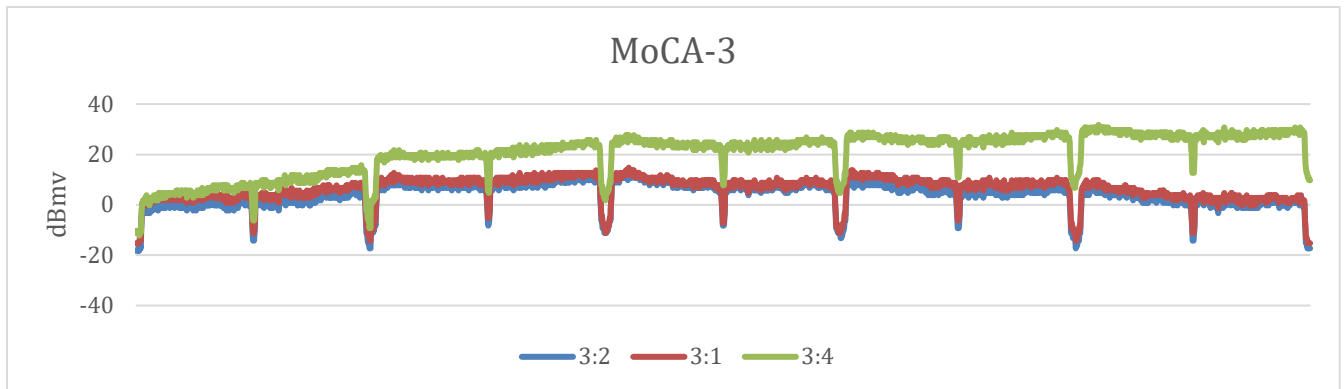

Figure 14 - MoCA-3 PTP EVM Probe Overlay To MoCA-1, 2 And 4

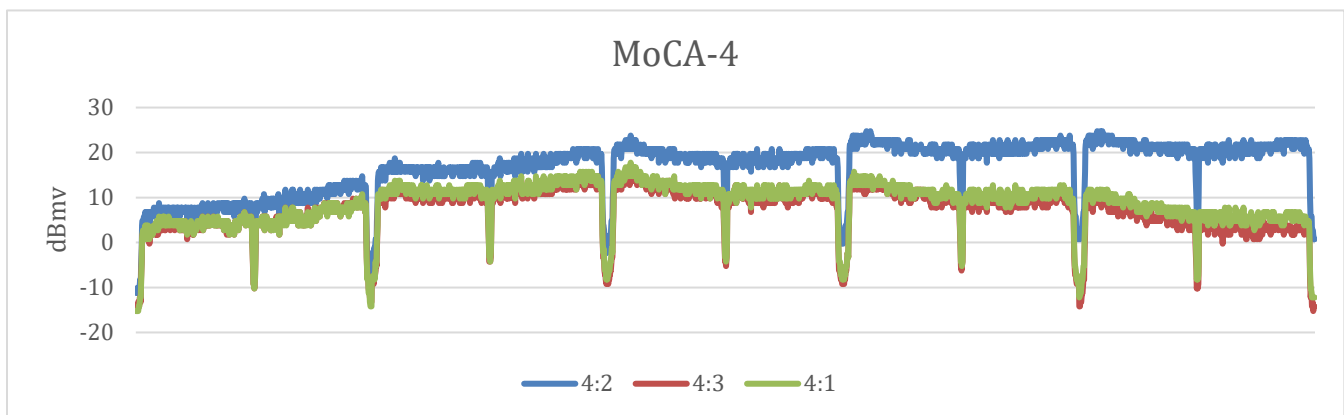

Figure 15 - MoCA-4 PTP EVM Probe Overlay To MoCA-1, 2 And 3

Figure 16 demonstrates the potential to detect suckouts. In this example, we see a highly attenuated signal below D1. This response is actually the lower edge of the high-pass filter (HPF). The HPF is allowing only D1 – D10 channel and rejecting all frequencies below 1,125 MHz internal of the MoCA embedded device.

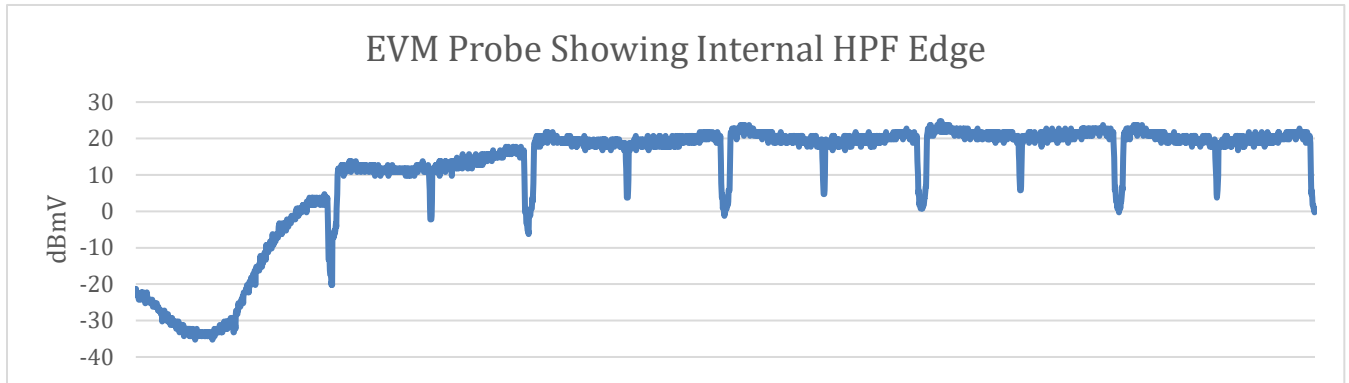

Figure 16 - PTP EVM Probe Showing HPF Edge

6. Detecting Missing Point-Of-Entry (POE) Filters

Point-of-Entry (POE) filters are installed in a subscriber's drop to provide optimum MoCA security and performance. Some acceptable locations for POE filters in the subscriber drop include at the tap spigot, ground-block, or as the closest possible point on the WAN side of the root splitter or drop amplifier input, see Figure 17 for an illustration.

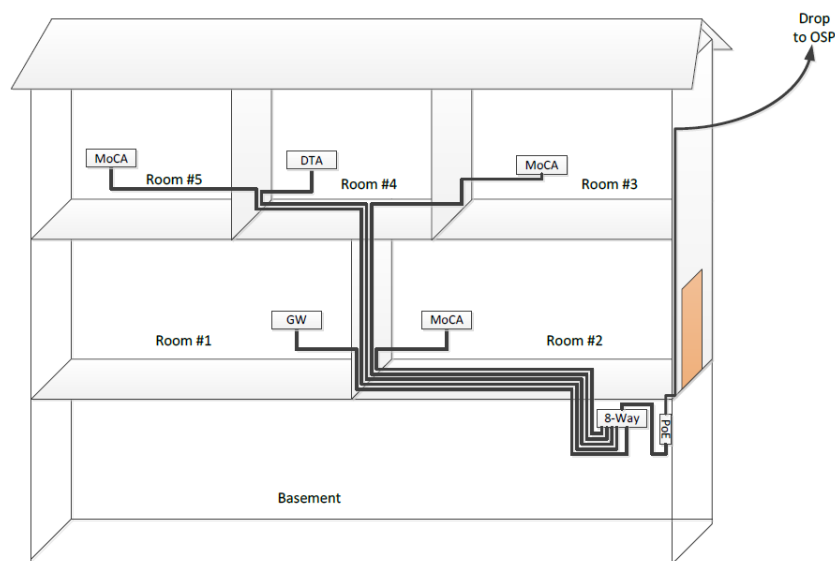

Figure 17 - POE Filter Installation Example

POE filters are low pass filters and correctly including them in a MoCA install serves two key purposes. The first purpose is to isolate the home network from neighboring home networks by attenuating the MoCA signals at the home network's point of entry. Deployment of well-designed POE filters can prevent neighboring MoCA from seeing each other and protect a MoCA network from any eavesdropping.

The second purpose POE filters serve is that they improve the MoCA connectivity with their 0 dB return loss in the MoCA frequency band. MoCA signals that are incident on the POE filter will reflect, with no loss contribution from the POE filter, back into the home network, and can result in a stronger MoCA signal if the reflected path has lower loss than the original path. A thorough explanation of POE filter response can be found in [1]

Cable operators may have discovered that installing POE filters in every MoCA deployment has proven to be challenging. Ideally, POE filters are installed at the tap spigot or the ground block for every MoCA deployment, however POE filters aren't included in all installations or are inadvertently removed by the customers. When POE filters are missing, MoCA becomes susceptible to security and performance issues previously described.

Remote detection of missing POE filters is ideally done prior to or during MoCA activation, providing real time feedback to the onsite installer or customer and ensuring optimal security and performance. Methods that detect missing POE filters via bridged MoCA networks are unacceptable because detection is happening too late, when both security and performance may have already been compromised.

There are multiple methods of analyzing MoCA channel characteristics to detect the influence the POE filter presence has on a MoCA network. Remembering that a properly installed POE filter fundamentally impacts the home network MoCA channel RF characteristics, and exploiting that knowledge enables the cable operator to look at a variety of home network characteristics in order to assess whether or not a POE filter is present. For this paper, we will consider echoes, tilt, and attenuation (of continuous waves) as potential methods for detecting POE filters in MoCA deployments.

Echo Detection

Approximately 0 dB return loss of the POE filter will introduce additional MoCA signal propagation paths, where the net effect on the channel response will be ripple. Traditionally, passband ripple has been considered to be bad in the legacy PNM mindset, because echoes in access networks usually means pairs of damaged or defective HFC components contributing to the generation of echo.

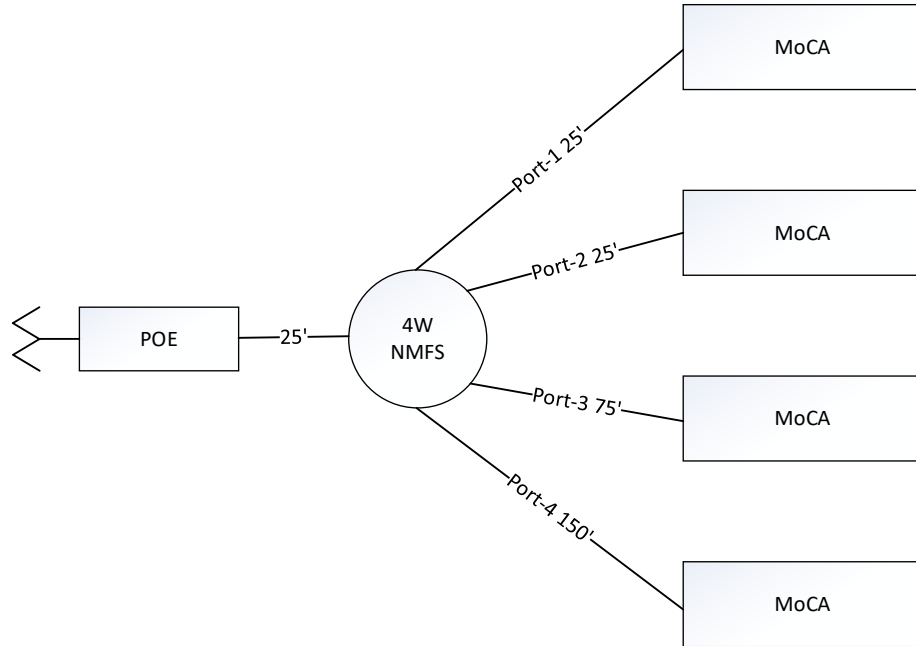

Figure 18 - 4-Way Non-MoCA Friendly Splitter With 25' POE 75Ω Terminated

Echoes in the MoCA network are actually good and in fact intentional, because of the introduction of the POE filter, thus detecting them within the MoCA network tells the cable operator that the POE filter has been successfully included in the MoCA activation. Figure 19 is example of a MoCA RF channel response with and without a correctly installed POE filter, it can be seen that the POE filter MoCA channel response has appreciable ripple, while not including the POE filter results in a much flatter channel response.

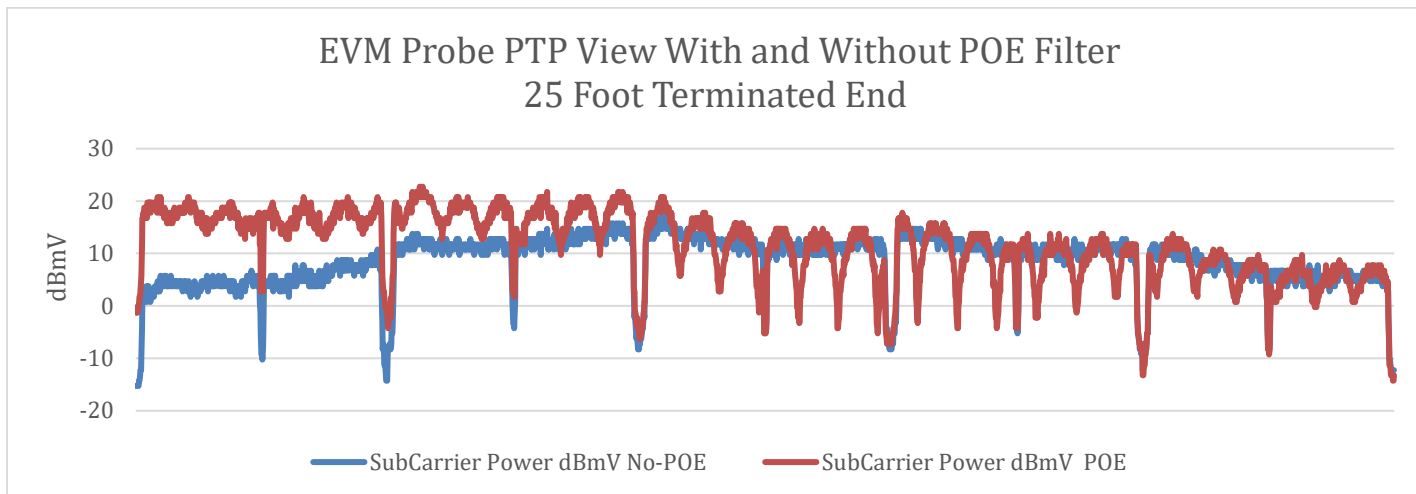

Figure 19 - EVM Probe PTP Viewpoint With/Without POE

7. Tilt Detection

Channel responses that include a POE reflection path, the blue path of *Figure 20* may be the dominant, or least loss path, and strongest when the POE filter is installed at the input of the root device. A root device may be either a MFDA or MFS, resulting in increased tilt from insertion loss instead of the OP2OP isolation. Differentiating between MFDAs and MFSs versus non-MoCA friendly equivalents is important because the suckouts present in non-MoCA friendly devices could corrupt the POE filter detection process. Therefore, detection of compatible home network devices, with more predictable RF performance throughout the MoCA band will be needed before attempting to detect the presence of POE filters.

MoCA based CPE installed in homes without POE filters will depend largely on OP2OP isolation of the root device, the red path in *Figure 20*, which ideally is a flat loss or possibly reverse tilted loss versus frequency for MoCA-friendly amplifiers and passives, resulting in less forward tilt than the path with the POE filter.

Thus another approach for detecting installed POE filters could be in analyzing the forward tilt observed across the MoCA devices. The approach would be similar to previous CCDF approaches, but in this case the analysis would aggregate tilt measurements into a CCDF, and compare those measured CCDFs to an established tilt threshold CCDF that is associated with installed POE filters. Threshold comparisons, like what has been illustrated in *Figure 21*, could be used to decide whether or not POE has been installed by essentially detecting the additional tilt, from the root device and cable, associated with the MoCA signals traversing the blue path of *Figure 21*. Threshold CCDF could be based on population measurements of POE filtered MoCA deployments and may converge to a minimum tilt value, where tilt is defined as the approximated linear variation versus frequency across the MoCA operating band.

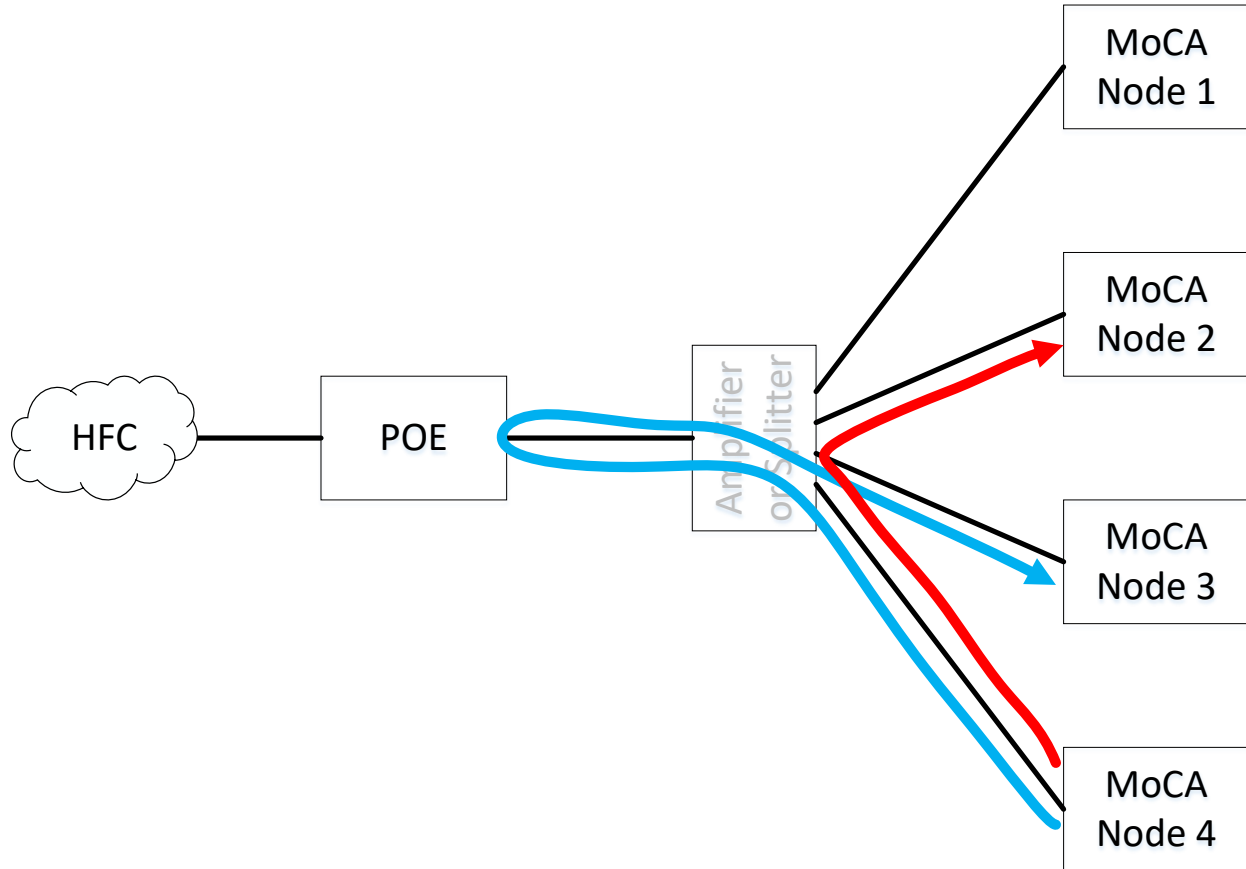
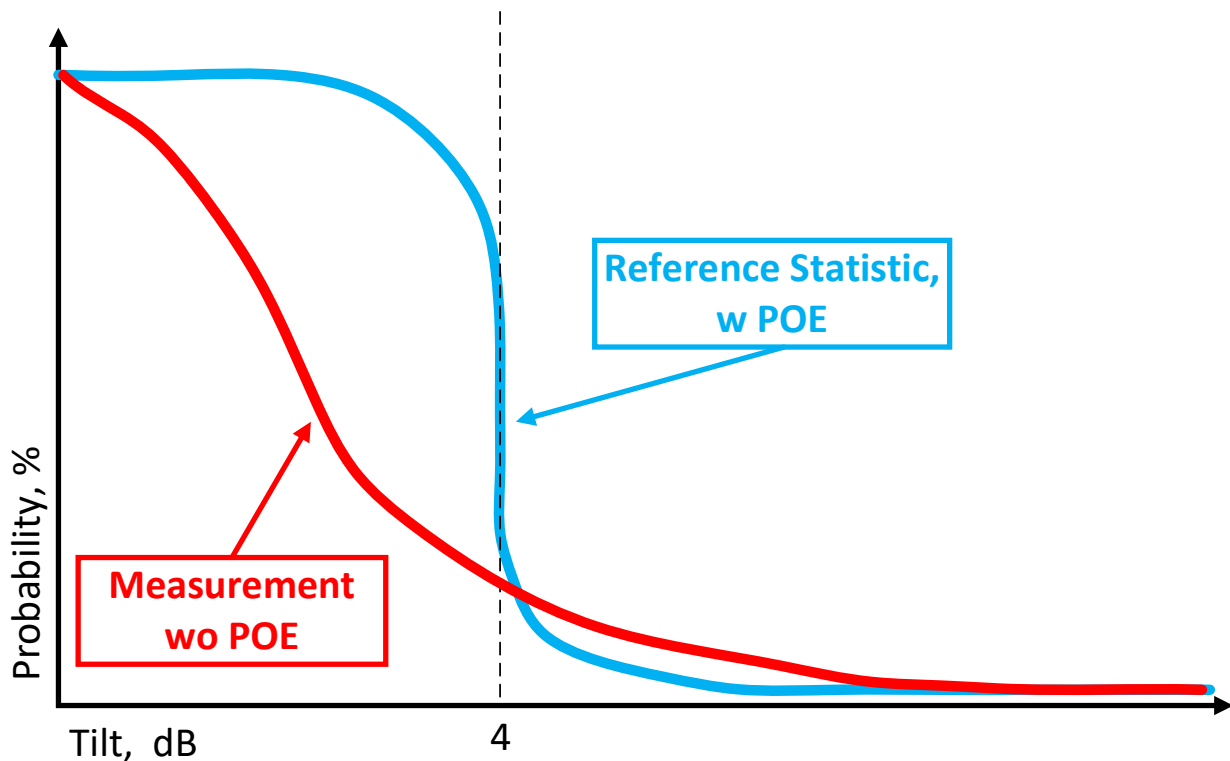

Figure 20 - MoCA Communication Paths With A POE Filter Present

In cable networks, attenuation increases with frequency in both the insertion loss of coaxial cable, drop amplifiers, and splitters. On the other hand, vendors design drop amplifiers and splitters to meet a constant OP2OP isolation value across frequency. These subtle differences of attenuation over frequency may provide enough clues to enable cable operators to distinguish when any given network is dominated by OP2OP isolation or Insertion Loss, like in the case of Figure 21, where a CCDF observation with less forward tilt reveals its average tilt to be lower than the population threshold.



**Figure 21 - MoCA Tilt Assessment Against Correctly Installed POE Filter
Population Threshold**

8. CW Detection

Another approach, albeit simplistic and limited, to detecting the presence of POE filters could be through the use of continuous wave (CW) signals. Traditionally, cable operators have used CW signals to perform access network RF alignment. A typical scenario would be for a cable operator to localize CWs at low, medium, and high center frequency locations. The CW RF signal level would be measured via access network test points, typically available in active elements such as Optical Nodes.

This is a proposal to continue the use of CWs not just for access network RF alignment, but detect whether or not a POE filter is within the home and significantly attenuating the CW, as would be observed by a MoCA capable CPE and illustrated in Figure 22. In order to accomplish this, the CW would ideally be centered at the lowest receive frequency of the MoCA capable CPE, or 1,125 MHz. In order for the center frequency adjustment to successfully broadcast from the headend to all subscribers, the access network would have to have been upgraded to allow passage of downstream signals up to at least the DOCSIS 3.1 requirement of 1,218 MHz.

The access network is designed to ideally deliver 0 dBmV over frequency, of all downstream signals, to all CPE, though some variation is expected, in fact some cable operators may maintain a range like an RF receive level between +10 to -8 dBmV per 6 MHz signal. CWs used for RF alignment purposes may be maintained to be slightly higher than their service delivering signal counterparts. The unique path loss (PL) associated with each customer deployment is primarily what determines the downstream RF receive level to customer CPE, which varies with drop length and equipment used, including passives, amplifiers, and POE filters, within the home networks. DOCSIS 3.1 networks will likely exhibit the lowest PL since they are designed to support up to 1,218 MHz pass band, with design budget allowances for up to 200' of RG11 drop cable and four outlets, path loss should be at its lowest below

the start of the MoCA operating band, or 1,125 MHz. Above 1,125 MHz the POE lowpass filter response will significantly attenuate signals coming into or out of the home in order to isolate MoCA networks from one another. Therefore, the broadcast CW receive level should be appreciably attenuated, below the expected receive level range previously discussed by at least 40 dB or more depending on the POE filter design. Figure 22 illustrates a case of a missing POE filter. The downstream passband between 1,002 and 1,218 MHz will only be used by D3.1, which is why it has been labeled as such. When no MoCA POE filter is installed, the CW will pass through both the access and home network with attenuation expected for all downstream access network signals, and hence be detectable by home CPE capable of operating at 1,125 MHz, i.e. MoCA nodes.

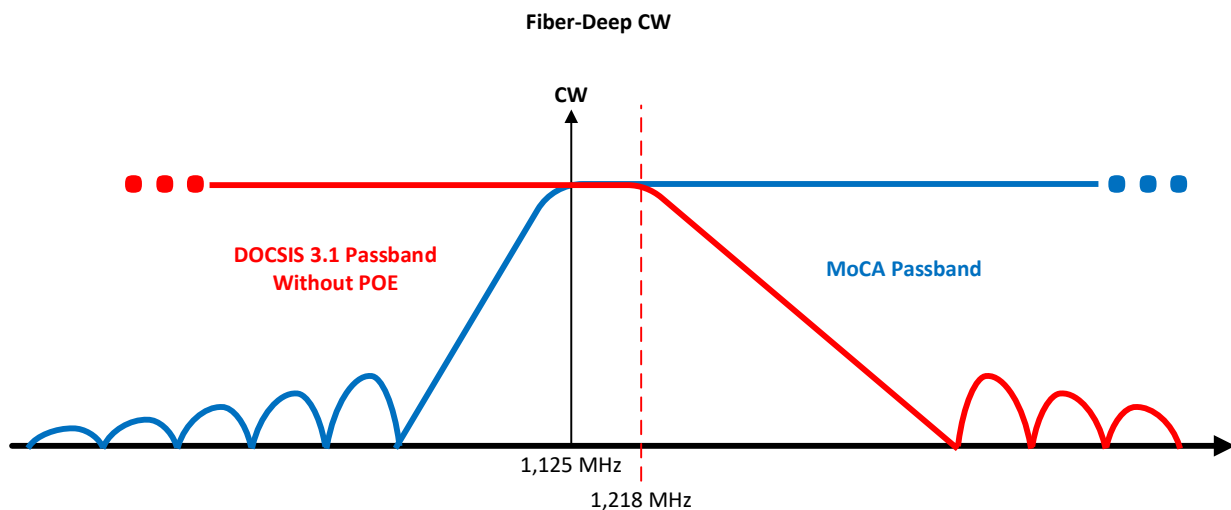

Figure 22 - Expected Passband Responses, No POE Filter Present

Correctly installed POE filters will exhibit the most attenuation above the POE filter cutoff range, 1,002 MHz for example. POE filters provide a stopband attenuation of at least 40 dB starting at 1,125 MHz. Acceptable methods for missing POE filter detection would involve defining CW downstream receive power as the KPI for the deployment population to establish known thresholds for this value, when POE filters are correctly installed. Remote detection of the POE filter could be performed by first collecting an estimate from all MoCA nodes within a subscriber home network in question, and determining whether the CW receive power is lower than a population threshold, for example -40 dBmV.

MoCA 2.0 SNMP MIB can be used to support each of discussed approaches for detecting missing POE filters. Through either analyzing channel characteristics including ripple or tilt responses or by detecting broadcasted CWs in the access network, MoCA 2.0 nodes are capable of providing valuable information regarding the contribution of a correctly installed POE filter. Cable operators can now leverage this information to provide timely feedback to installers or customers when missing POE filters are detected, and circumvent any loss of performance and/or security of MoCA.

. Up to this point, this paper has only discussed the value MoCA PNM can bring to existing cable operator services, we would now like to discuss how MoCA PNM can assist with enabling a new service, a higher upstream capacity or midsplit based service delivery.

9. New service assessment, Midsplit Self Install Kits (SIK)

Self-install kits (SIK) represent significant percentage of cable operator's new technology rollouts, allowing for optimized deployment and operations and would ideally continue with the rollout of network capacity enhancements, including D3.1 midsplit technology. Newer generation cable operator product's, including the D3.1 capable products may be capable of remotely changing their return path

diplex filter configuration from a traditional standard split diplex to a midsplit diplex filter. The traditional standard split diplex filter supports return path of 5-42 MHz, or approximately a 30 Mbps upstream speed service tier, while the midsplit diplex filter can support an expanded return path, or 5-85 MHz, which would enable service providers to provide approximately 100 Mbps (or higher) upstream speed service tier to customers.

Midsplit SIK success depends upon a cable operator's ability to remotely qualify customer home networks for enhanced capacity services, without compromising existing revenue generating services, such as video. Cable operators, via their installation practices, craftsmanship, and home network product performance, typically maintain a path loss, of at least 25 dB, between a D3.1 midsplit-capable product and any video device. However, use of many commercially available home network products, from common retail channels, may result in a much lower path loss than cable operators' 25 dB value. We have observed through limited laboratory testing, that D3.1 midsplit-capable transmissions within the 54-85 MHz band can disrupt existing video services when the transmission power of the D3.1 midsplit-capable device is approximately 20 dB higher than the video signal receive power, at the set top box receiver. The higher D3.1 midsplit-capable transmission power can cause many set top boxes to become nonlinear via a phenomenon known as adjacent channel interference (ACI) or more commonly known as ACI susceptibility.

In order to remotely assess whether a customer could participate in midsplit self-install, knowledge of the path loss between the current cable modem and set top boxes would need to be known. If these devices also supported MoCA, then the tools previously presented could be leveraged here to get a path loss estimate for cable operators. Using MoCA 2.0 SNMP MIB data associated with the ACA OIDs, path loss estimates would be collected for the MoCA operating band.

Using MoCA band path loss estimates combined with known product specifications for drop amplifiers, splitters, and drop cable, cable operators could estimate path loss for the midsplit operating band, provided that no incompatible devices were detected in the MoCA home network. As an example, if a cable operator were to measure 20 dBmV receive level from a ACA EVM probe, then subtracting that value from the known transmit level of 55.75 dBmV would result in a MoCA path loss of approximately 35.75 dB. If a POE filter was detected and 4-way MoCA-friendly splitter was used, then the path loss would be dominated by the splitter's IL and not OP2OP isolation.

The MoCA-friendly IL for the MoCA operating band is 11.5 dB, and 4 dB less, or 7 dB, for midsplit operating band. Deducting 11.5 dB twice from the path loss, remembering that the MoCA signal passes through the splitter twice when a POE filter is installed, then the remaining 12.75 dB can be assumed to be from cable attenuation. RG6 drop cable has approximately 8 dB loss per 100 ft, in the MoCA band, resulting in an equivalent RG6 cable length of approximately 155 ft.

Estimating the midsplit band loss, based on 2 dB loss per 100 ft, for the same length of cable results in approximately 3 dB of cable attenuation. The 3 dB of cable attenuation is an estimated value and may not be a true representation of cable loss for a variety of reasons, for example, the POE filter and the root splitter may not be collocated. Additionally, the equivalent midsplit attenuation for this example needs to be based on the OP2OP isolation of the splitter, or 25 dB, because the midsplit signals won't reflect off the POE filter. Therefore, the midsplit path loss estimate is 25 dB + 3 dB = 28 dB.

Armed with the midsplit path loss, cable operators can estimate whether there will be an ACI susceptibility issue when activating a midsplit service. The estimation requires either querying the CM for its maximum transmit power or obtaining its maximum transmit power from the manufacturer specifications. A value of 57 dBmV per 6.4 MHz could be an example of a maximum upstream transmit power. The minimum set top box receive power will also need to be queried as well, for example 0 dBmV per 6 MHz. The desired to undesired signal ratio (D/U) can be estimated with the downstream set top signal being the desired signal, and the CM upstream transmit signal being the undesired signal via Equation 3

Equation 3: Set Top Box Desired To Undesired Ratio Estimate (D/U)

$$\frac{D}{U} = [U(\text{Upstream Transmit Power}) - D(\text{Downstream Receive Power})] \\ - \text{Midsplit PL}$$

To finish our earlier example, a $D/U = 57 \text{ dBmV} - 0 \text{ dBmV} - 28 \text{ dB} = 29 \text{ dB}$. Since the D/U is 29 dB, or 9 dB higher than our previously referenced threshold of 20 dB, this home network will likely require remediation in order to support midsplit based services and therefore would not qualify for a SIK. Remediation would involve improving the isolation between the CM and set top boxes. There are different ways of accomplishing this, either with enhanced isolation splitters providing OP2OP isolation of $\geq 35 \text{ dB}$ or via notch filters, whose stop band attenuation would add $\geq 48 \text{ dB}$ isolation. Both of the remediation approaches discussed would likely require field installer support.

10. Conclusions

Multiple use cases have been examined where MoCA can uniquely assist cable operators in solving a variety of challenges associated with secure and optimal MoCA deployment. Excessive loss conditions between individual MoCA links can be identified, possibly from incompatible device suckouts. Missing POE filters, negatively impacting security and performance can be identified much earlier in the MoCA deployment process. Lastly, ACI susceptibility issues preventing midsplit service rollouts may be identified using MoCA PL estimates in conjunction with existing DOCSIS telemetry metrics for CMs and STBs.

The additional data flows from MoCA diagnostics can be managed and acted upon based on thresholds aggregating large deployment populations of MoCA-capable devices. The referenced KPIs, including path loss, tilt, and receive power, were illustrated to show how KPIs can be any meaningful variable needed by cable operators wishing to make diagnostic decisions and the CCDF curve can be a way to facilitate meaningful comparison between established and new performance datasets.

11. Acknowledgements

With great appreciation, the authors acknowledge Jon Cave, Saifur Rahman and Tom Lookabaugh from Comcast, Jeff Cannon Sr. from H.J. Cannon Group, Inc., and Rob Gelpman from MoCA for their thoughtful review and guidance in helping us prepare this material for publication.

12. Abbreviations And Definitions

ACA	Alternative Channel Assessment
ACI	Adjacent Channel Interference
CAE	Customer Account Executive
CATV	Cable Television
CDF	Cumulative Distribution Function
CCDF	Complimentary Cumulative Distribution Function
CM	Cable Modem
CMTS	Cable Modem Termination System
CPE	Customer Premise Equipment
CW	Continuous Wave
DOCSIS	Data over Cable System Interface Specifications
EVM	Error Vector Magnitude
ExD	MoCA Extended D
FMR	Full Mesh Rate
Hz	Hertz
KPI	Key Performance Indicators

NMFS	non-MoCA-friendly splitter
MFS	MoCA-friendly Splitters
MIB	Management Information Base
MoCA	Multimedia over Coax Alliance
MPTMP	Multipoint-to-Multipoint
OP2OP	Output-Port-to-Output-Port
POR	Point-of-Entry
PNM	Proactive Network Maintenance
PTMP	Point-to-Multipoint
PTP	Point-to-Point
ISBE	International Society of Broadband Experts
SCTE	Society of Cable Telecommunications Engineers
SIK	Self-Install Kit
SNMP	Simple Network Management Protocol
SNR	Signal-to-Noise
SoC	System on a Chip

13. Appendix

All data collected for this paper can be accessed at: <https://github.com/mgarcia01752/SCTE-NOS-2017-JOURNAL-MOCA-PNM-PARADIGM-SHIFT>

14. Bibliography And References

- [1] SCTE, "Operational Practice for the Coexistence of DOCSIS 3.1 Signals and MoCA Signals in the Home Environment" [Online]. Available: <http://www.scte.org/SCTEDocs/Standards/SCTE%20235%202017.pdf>
- [2] M. Garcia, "SCTE-NOS-2017-JOURNAL-MOCA-PNM-PARADIGM-SHIFT," 2 9 2017. [Online]. Available: <https://github.com/mgarcia01752/SCTE-NOS-2017-JOURNAL-MOCA-PNM-PARADIGM-SHIFT>.

SIMPLIFYING FIELD OPERATIONS USING MACHINE LEARNING

A Technical Paper prepared for SCTE•ISBE by

SANJAY DORAIRAJ
SENIOR DIRECTOR, COMCAST INNOVATION LABS
COMCAST CORPORATION
1050 ENTERPRISE WAY, SUNNYVALE, CA 94089
Phone: 2159002349
Email: Sanjay_Dorairaj@cable.comcast.com

CHRIS BASTIAN
CTO, SCTE
140 Philips Road, Exton, PA 19341-1318
Email: cbastian@scte.org

BERNARD BURG
SR MANAGER, DATA SCIENCE, COMCAST APPLIED AI
COMCAST CORPORATION
1050 ENTERPRISE WAY, SUNNYVALE, CA 94089
Phone: 408-900-8575
Email: Bernard_Burg@cable.comcast.co

NICHOLAS PINCKERNELL
DATA SCIENTIST
COMCAST CORPORATION
1899 WYNKOOP #550, DENVER, CO 80202

Table of Contents

Title	Page Number
Introduction _____	68
Operational Practices _____	69
1. Machine Learning Overview _____	69
2. Applications of Machine Learning for MSOs _____	71
2.1. Supervised versus Unsupervised Learning _____	73
2.2. Training set, Test set and Hyperparameters _____	74
2.3. Feature engineering _____	74
2.4. Ensemble approaches _____	75
2.5. Online versus offline algorithms _____	75
3. Operational Efficiency Improvements Using Machine Learning _____	75
3.1. Machine Learning – A New Operations Paradigm _____	76
4. Typical Development Methodology _____	76
5. Case Study: Spectral Impairment Detection _____	78
6. Design Approaches _____	78
6.1. Mathematical Modeling _____	79
6.1.1. Feature Detection _____	80
6.1.2. Example of impairment detection: Tilt and roll-off _____	81
6.1.3. Results _____	82
6.2. ML Models: Towards an Optimal Solution _____	83
Conclusion and Recommendations _____	84
Abbreviations and Definitions _____	86
Bibliography & References _____	86

List of Figures

Title	Page Number
Figure 1 – From the Stone Age to the Age of Big Data and Machine Learning	68
Figure 2 – Cambrian Explosion of Data (Source: Patrick Cheesman)	69
Figure 3 – Data Science Venn Diagram	71
Figure 4 – Data requirements for supervised and unsupervised algorithms	74
Figure 5 – Machine Learning Workstreams	77
Figure 6 – Machine Learning Process (Source: Crisp Industry Standard Process for Data Mining - CRISP DM)	78
Figure 7 – A few RF spectrum impairment samples	78
Figure 8 – Spectral impairments and their shapes	79
Figure 9 – Spectrum, channels and features	80
Figure 10 – Feature Detection	81
Figure 11 – Tilt and Roll-off detection	81
Figure 12 – Suckout, notch, foreign carrier and resonant peaking classification	82

Figure 13 – Prediction example – wave, tilt and suckout	82
Figure 14 – Comcast Labeling Machine solution overview	83
Figure 15 – Comcast Labeling Machine – Labeling impairments	84

List of Tables

Title	Page Number
Table 1 – Data Modeling vs Machine Learning approach	69
Table 2 – Machine Learning algorithms	73

Introduction

Every so often in the history of our evolution, humans discover something so important that it propels us into a new plane of technological and intellectual superiority. Over two million years ago, the **Stone Age** helped us build tools that established us as the dominant species on this planet. Much later, the **Bronze Age** (circa 3500 BC) and the **Iron Age** (circa 1200 BC) catapulted us to new levels of technological sophistication through the introduction of coin-based currencies, faster means of transport, durable manufacturing and construction and numerous other developments. This laid the foundation for the **Industrial Age** (circa 1700 AD), which ushered in the age of mechanized agriculture, mass transportation and electronic communication. The invention of the computer and the internet in the later parts of the 20th century heralded the dawn of the **Internet Age**. Individuals anywhere on the globe could now communicate and exchange information with one another. And much like Ray Kurzweil's Law of Accelerating Returns [1], the Internet Age is hardly over. Now, we find ourselves at the cusp of two back to back, tightly coupled events that are also bound to be of equally great historical significance - the **Age of Big Data** and the **Age of Machine Learning**.



Stone Age



Bronze Age



Iron Age



Industrial Age



Internet Age



**Age of Big
Data and
Machine
Learning/AI**

Figure 1 – From the Stone Age to the Age of Big Data and Machine Learning

The explosion in data aka "Big Data", is a direct result of the exponential improvements in computing power and storage, with similar decreases in their cost [2]. This fueled an abundance of both personal and organizational data. The chart, below, provides a dramatic portrayal of the rapid growth of data over just one decade. Despite all of this data, the insights that we were able to generate has been limited by decades-old statistical and mathematical techniques and there wasn't much innovation in this field. The advent of Machine Learning is propelled us forward, by offering techniques that transform the big data into a veritable gold mine of valuable insights.

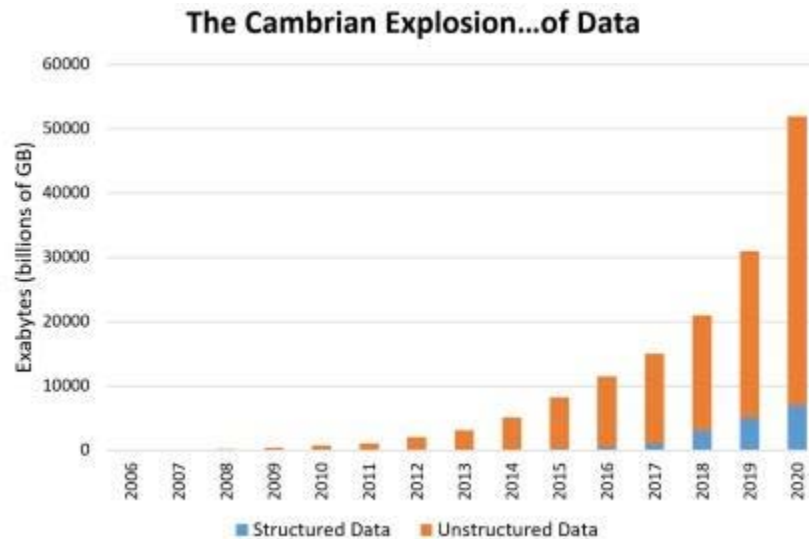

Figure 2 – Cambrian Explosion of Data (Source: Patrick Chéesman)

This paper is about machine learning - its definition and its applications. It especially examines the relevance of machine learning from the perspective of the cable industry’s multiple system operators (MSOs). While there have been some attempts in technical and trade literature to pinpoint the benefits of machine learning to MSOs, there has not yet been a holistic treatment of the subject, to our knowledge. This paper is an attempt to fill that gap.

Operational Practices

1. Maching Learning Overview

Definitions of machine learning tend to compare it with traditional statistical methods. Leo Breiman, one of the pioneers and early evangelizers of machine learning, talked about the two cultures of statistical modeling - the data modeling culture and the algorithmic culture [3]. In the **data modeling approach**, which could be compared to traditional statistical approaches, the model assumes an underlying stochastic process. Inferences are made using techniques such as linear and logistic regression. Sample sizes are determined based on concepts founded in probability and inferential statistics and generally tend to be a tiny portion of the population size. **Machine learning** or the **algorithmic approach**, on the other hand, does not assume the existence of a well-defined process to the underlying data. Instead, it treats the model as a black box. Machine Learning algorithms such as neural nets and decision trees try to decipher the underlying patterns in the data using methods similar to that of maximum likelihood estimation. These algorithms typically require large amounts of data in order to yield good predictions.

Table 1 – Data Modeling vs Machine Learning approach

Data Modeling Approach	Machine Learning Approach
------------------------	---------------------------

Sample data requirements	Low	High
Constraints	Several	Few
Validation	Goodness of fit, residual examination	Performance on an independent test data set
Multiple variable prediction accuracy	Low	High
Data Interpretation characteristics	Linear or curvilinear patterns that can be approximated as functions	Complex non-linear patterns

Traditional inferential statistics has found its niche in several areas such as predicting an election outcome or predicting the effects of a new medication on a population. They perform well when the number of predictor variables are low. As the number of predictor variables increase, these models tend to break down. This is because of the large number of constraints these models are required to satisfy in order to yield valid predictions [4]. As the number and diversity of predictor variables increase, it becomes more and more difficult for these constraints to be met. On the other hand, machine learning algorithms are capable of dealing with complex processes and millions of predictor variables. The key requirement for machine learning to be successful is a data-rich environment, and the explosion of data in organizations today has proven to be instrumental in the increasing popularity and success of machine learning.

What role does machine learning play in Artificial Intelligence (AI)? AI is an overarching term that encapsulates all attempts to instrumentalize technology with the ability to think and act independently, much like humans do. It refers not only to the software and algorithms that renders this capability but the hardware and control systems as well. Machine Learning can be viewed as the subset of AI technologies that deals with pattern recognition.

A crucial advantage that humans have over existing computing platforms is our ability to make inferences from a complex set of input events. For example, our eyes are sophisticated enough to visually process information in three-dimensional space and recognize objects and emotions with little difficulty. Another example is our ability to look at a multi-variable time-series chart and immediately identify the anomalies present. The intelligence that enables us to excel at these tasks can be traced down to our uncanny ability to leverage our historical knowledge to perform real-time pattern matching. Machine learning and its derivative technology – Deep Learning, render computing platforms with pattern matching skills. In some cases, they are far superior to humans because they can process numerous parameters and complex underlying processes in an almost unbounded manner, limited only by computing and storage costs. In addition to the strong reliance on mathematics and statistics, machine learning is also strongly tied to software development, since the amount of data that it needs to be successful requires the use of state of the art software development methodologies.

The below diagram succinctly captures the overlapping areas of knowledge that data science comprises of computer science, mathematics, statistics and domain expertise. The *unicorns* in the middle refer to those data scientists who possess the rare combination of all these skills.

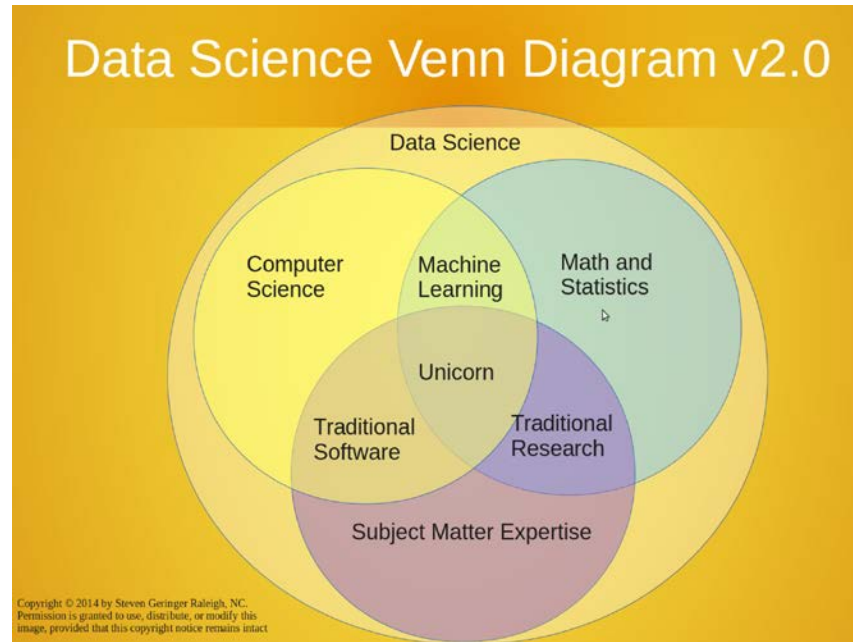

Figure 3 – Data Science Venn Diagram

2. Applications of Machine Learning for MSOs

In this section, we define general classes of machine learning algorithms and discuss how these classes of algorithms can add value to service providers.

The general classes of machine learning algorithms

1. Classifiers
2. Clustering Algorithms
3. Recommender Systems
4. Anomaly Detection Algorithms
5. Linear Regression

Classifiers are used to discern similarities among sets of data and assign them to categories based on their similarity. Examples of classification could be identifying objects in a video frame, identifying the underlying sentiment in a customer service message – happy, upset or neutral, or, associating a log message from a set-top to a specific error class. The technologies powering classifiers range from the simple - decision trees and random forest, to the very complex - deep neural networks. The choice of technologies used are typically functions of the level of complexity and the number of features in the underlying data. Image classification has been shown to benefit greatly by technologies derived from neural nets such as convolutional neural nets (CNNs).

Clustering algorithms group similar data into clusters. They are typically used to group data that share similar characteristics or to look for significant deviations in data. For example, clustering algorithms could be used to look at smart home data and create user profiles based on shared behavioral characteristics – for example, early risers, late risers and so on. Clustering algorithms range from the

simple such as K-Means clustering to more advanced algorithms such as agglomerative hierarchical clustering that may require additional tuning for optimal performance.

Recommender systems are a class of algorithms that make user or product recommendations based on historical usage or behavioral data. They can be used to suggest movies to users based on what those users have watched in the past or based on what users with similar viewing habits may have watched. For example, if two users like *Star Wars* and one of the users has watched *Dark Matter*, another sci-fi series, then the recommender would suggest *Dark Matter* to the other user. In a similar way, they can also be used to recommend products that users would like to purchase. In the case of customer service, they can recommend actions that the customer service representative can take in a given situation based on past actions. A popular method of building these recommendations is using an algorithm called Collaborative Filters.

Anomaly Detection algorithms are similar to classification algorithms except that they typically only deal with cases where there just two classes of data exist and where one class occurs with an extremely low frequency. If the anomalies are relatively large, then clustering algorithms can be used; however, if anomalies are very few, joint probabilistic methods to model the rare events are more appropriate. Anomaly detection can be used to look for events such as billing fraud and device errors in cases where device failure are rare.

Linear Regression algorithms are used in order to make predictions about continuous variables. An example could be predicting customer churn rate or predicting bandwidth utilization. Linear Regression and Classifier algorithms share similar characteristics with respect to the technologies that are used. Where they differ is while classifier algorithms are designed to maximize the separation between dissimilar data points to allow for classes to be determined, linear regression algorithms interpret results in a continuous manner. One other point to note is that ML-based linear regression models are typically interpolative, traditional statistical linear regressions models are both interpolative and extrapolative. This only points to usage and does not imply that the traditional model is superior to the ML-model in cases where extrapolation is required.

The table below summarizes the above discussion.

Table 2 – Machine Learning algorithms

Class of Algorithms	Description	Technology Examples	Applications
Classifiers	Assigns data to categories based on similarity to other data.	Random Forest and Neural Nets	Sentiment Analysis, Image Classification
Clustering Algorithms	Groups similar data into clusters	K-Means, Hierarchical Clustering	User profiles and anomaly detection
Recommender Systems	Make recommendations based on historical data	Collaborative Filtering	Product recommendations
Anomaly Detection	Identify rare events	Joint Probabilistic modeling	Billing fraud detection
Linear Regression	Predict values for continuous variables	Linear Regression	Churn rate prediction

Discussed below are a few machine learning concepts and ideas that are also important to the successful application of machine learning.

2.1. Supervised versus Unsupervised Learning

As mentioned earlier, machine learning algorithms seek to find underlying patterns in data and mathematical ways of representing those patterns. The mathematical representation is referred to as a **model**. This search for patterns leads to two broad classes of machine learning – **supervised** and **unsupervised** learning. Given any set of data, if a machine learning algorithm is asked to determine underlying patterns in an autonomous manner, then that form of machine learning is known as unsupervised learning. Examples of unsupervised learning are (1) building consumer behavior profiles from customer call data and (2) classifying defect data into groups based on similarity between defects.

Supervised learning is guided learning. In this case, the data also includes a parameter known as a **label** that captures the system response to a given set of input parameters. In determining customer churn for example, the available data will include the number of issues seen by a customer on a set-top on any given day. These are the predictor variables. In addition to the predictor variables, supervised algorithms require a label that could indicate whether or not the customer tried to cancel service that day. Supervised algorithms can be used to build a model that can predict the probability of a customer cancellation from the predictor and response variables. These algorithms have been shown to be effective in improving customer diagnostics, optimizing call centers, increasing the efficiency of truck rolls, and pro-active network healing.

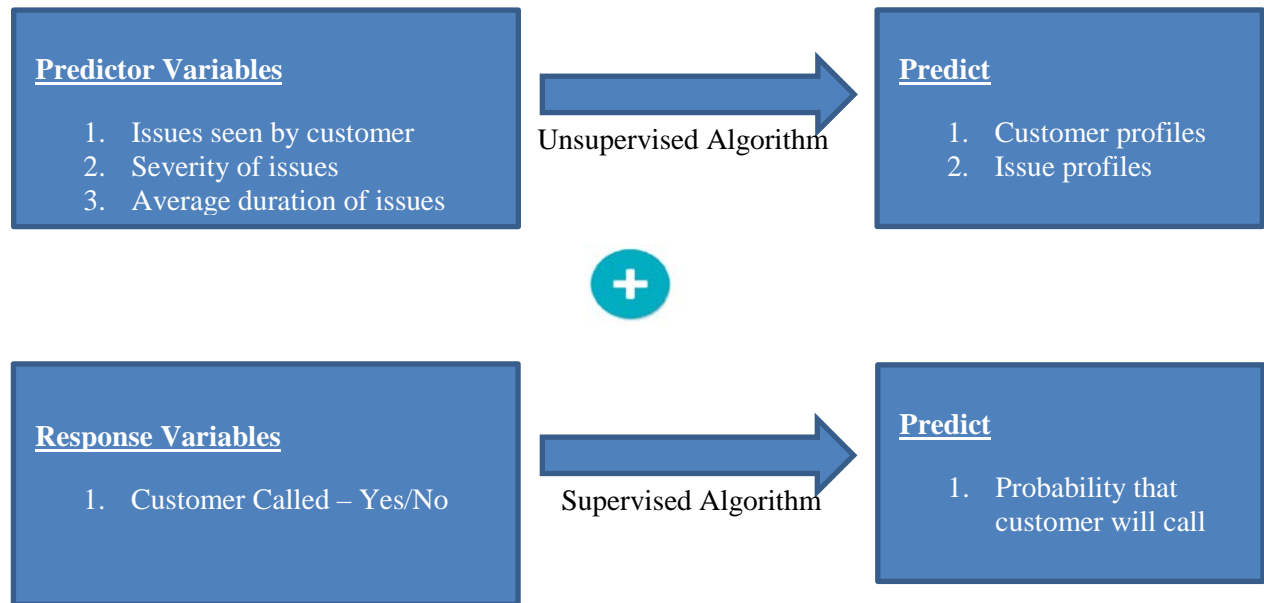

Figure 4 – Data requirements for supervised and unsupervised algorithms

2.2. Training set, Test set and Hyperparameters

Data used to build machine learning models is typically broken down into subsets - the **training data** and the **test data**. Training data is used to train the algorithm and allow it to build a model for the underlying data. Typically, the algorithm contains a number of tunable parameters, called **hyperparameters**, that are used to optimize the performance of the model. For example, when trying to use a clustering algorithm to build customer profiles, one of the hyperparameters is the number of clusters. In our examination of the resulting clusters from such an algorithm, we may notice that a certain cluster count yields a more optimal set of clusters than another cluster count. In a similar way, other hyperparameters can also be tuned till an optimal model is obtained. A key success factor for a machine learning model is to ensure that the training set and the test set are kept completely separate. This ensures the absence of any kind of bias during model generation. For this reason, hyperparameter tuning is not done using the test set, but rather, the training data is subdivided into a training set and a cross-validation set, and the cross-validation set is used to validate hyperparameters.

2.3. Feature engineering

There are two general variables that come into play with machine learning. The first type is referred to as a predictor variable and the second type is referred to as a response variable. Predictor variables are variables that are used to make predictions and response variables are the prediction. In image recognition, for example, pixels in an image are the predictor variables and the predicted class (cat, dog, flower etcetera) is the response variable. Similarly, when predicting the likelihood of a customer call, predictor variables could include the state of the set-top box modem and state of the infrastructure. In this case, whether or not the customer called, given the set of predictor variables, would be the response variable.

The selection of predictor variables is a crucial part of machine learning since the quality of the predictor variables ultimately determines the quality of the prediction. Predictor variables are also referred to as **features**. Feature selection is in itself a complex process and it has spawned a whole separate branch of machine learning called **feature engineering**. Feature engineering usually involves two types of activities (1) Reducing the set of all possible features into a set of features suitable that are better predictors of the output class and (2) Transforming or extending the set of available features with new features that are more suitable for the particular machine learning task. A popular method to transform one set of parameters into a smaller set of better predictor variables is called Principal Components Analysis (PCA).

2.4. Ensemble approaches

Often, when doing machine learning, the algorithms taken separately do not yield the best results. However, when combined with other machine learning algorithms or even multiple instances of the same algorithm, the quality of the results tends to improve. This is referred to as the **ensemble approach** to machine learning and this method is quickly gaining popularity in the machine learning community. The random forest algorithm is such as example. Sometimes, results from different algorithms such as random forest and support vector model (SVM), may be combined to yield a better classifier. Software tools include features that offer the programmatic selection of the best ensemble models through trial and error. A successful demonstration of the ensemble approach is the Netflix Prize which went to a team of machine learning engineers that developed the best algorithm using a similar ensemble approach [5].

2.5. Online versus offline algorithms

In certain cases, machine learning models may need to be built in real-time or **online** mode. For example, recommender systems need to process incoming events in real-time and provide recommendations based on the current state of the system. In this case, the model will need to be updated in real-time to ensure that the recommendations are up to date. In cases such as anomaly detection however, it may not be necessary to build a real-time model and an **offline** model is sufficient. In this case, models are built when data is available and refreshed with lesser frequency, perhaps on the order of weeks or months.

Depending on the type of application, an online or an offline model may be required. Not all machine learning algorithms work in an online model, so therefore, if choosing the online learning route, it is important that an algorithm that supports online learning is selected.

3. Operational Efficiency Improvements Using Machine Learning

As discussed above, there are several applications to machine learning. Some of the applications such as recommender systems, campaign management systems, market analysis and so on are revenue generating. Other applications have to do with cost optimization. These include customer call prediction, churn prediction, fault prediction, capacity planning and so on. In this section, we focus on the potential for machine learning to improve the operational efficiency of an organization.

Listed below are a set of reasons establishing how machine learning can help with operational efficiency goals.

- Cable system operators have a lot of data sources (understatement!) with valuable information about the state of the system
- These data sources are currently used only for basic- to medium-level analytics tasks, such as relative frequency comparison, difference computations and advanced visualizations.

- Predictive analytics using machine learning can help flag customer service issues in advance, presenting operators an opportunity to fix them before they disaffect service
- Machine learning tools can also be used to perform root cause analysis to identify underlying issues and recommend remediation actions
- When ML insight is deployed in development and field tools, it helps drive down call volume and truck rolls, thereby decreasing operational costs related to these activities

3.1. Machine Learning – A New Operations Paradigm

Machine Learning is a new paradigm of operations. This is especially true for field technicians who stand to benefit the most from this tool. Everybody likes certainty. When a DOCSIS monitoring device is plugged into an outlet, the expectation is that the spectral signature that they see is exactly what is present. The same goes for other measurements such as signal loss, signal-to-noise ratio, signal levels and so on. This is a deterministic paradigm where what is reported is exactly what is measured..

Machine Learning solutions are different. They do not provide answers that are a 100 percent guaranteed to be true. What you get is an answer and a probability associated with that answer being true. For example, in the case of a spectral impairment, the machine learning solution may say that there is a 95 percent chance of the signal containing a wave impairment. How should the field technician or the network operations center react to a probabilistic result? There are known methods of handling uncertainty and these are all based on an application's aversion to false positives.

Evaluating performance of machine learning models involves balancing cost reduction, customer satisfaction and model complexity. A large volume of repair calls implies that **small improvements can yield sizable cost saving**. Consider the below example

- 1 million repair calls a month at a hypothetical \$10 per call implies a monthly cost of \$10m per month.
- A **1 percent reduction** results in a 100-thousand-dollar monthly saving and an annual saving of approximately **1.2 million dollars**

Machine learning also provide means for tuning the model to yield a desired false positive rate. Reducing the number of false positives would however drive down the number of true positives, so there is a tradeoff that must be made. The examples below show two use cases – the first, where a high number of false positives is less desirable and a second, where a high number of false positives has an overall positive impact on the problem.

- A destructive self-healing action such as a reboot would require higher precision
- A non-intrusive self-healing action such as a billing change would allow for lower precision

Similarly, in the case of the spectral impairment detection case study considered in this paper, the machine learning algorithm would assign similar probabilities to each of impairment that it detects and the field operations and the network operations center should have a strategy to deal with this information in a meaningful manner.

4. Typical Development Methodology

The development and deployment of machine learning within an organization typically takes place as two parallel, though connected, workstreams. The **first workstream** is more centered on the modeling effort. The **second workstream** focuses on ensuring that there is a path to deployment for the models being developed. The two efforts are viewed as happening concurrently because of the complex nature of deploying a machine learning solution in a cable system operator's production environment.

The first figure below shows the two workstreams and the second figure below shows a high-level view of the machine learning model lifecycle.

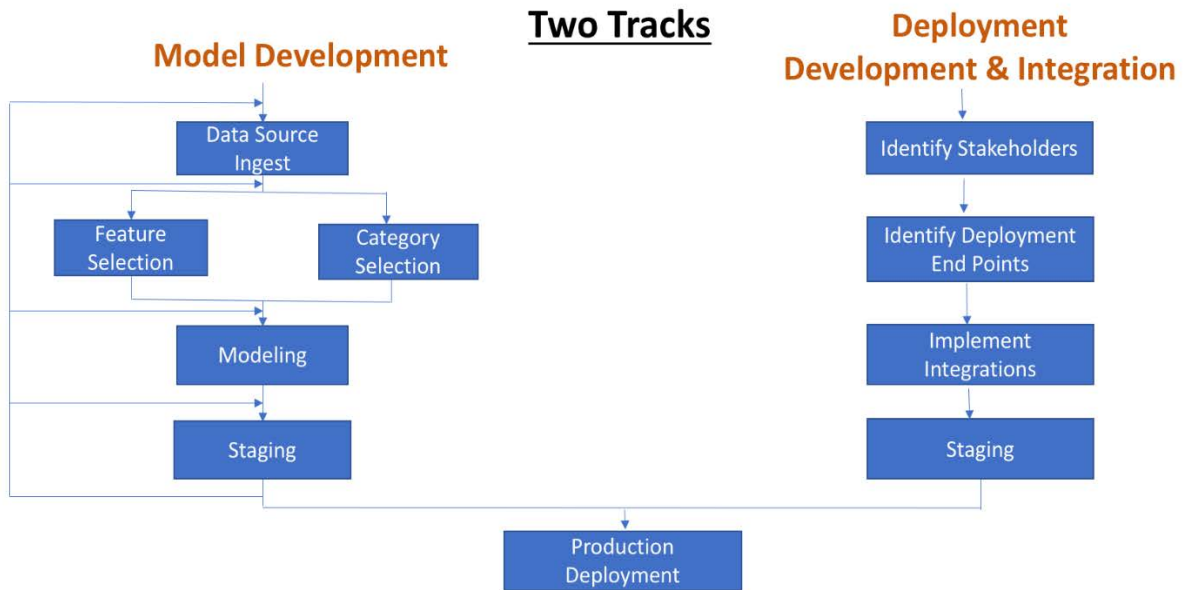

Figure 5 – Machine Learning Workstreams

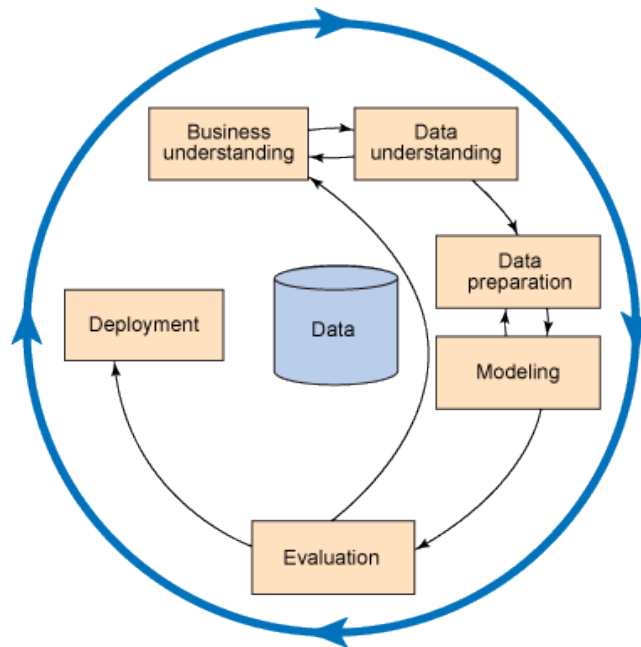

Figure:

Figure 6 – Machine Learning Process (Source: Crisp Industry Standard Process for Data Mining -CRISP DM)

5. Case Study: Spectral Impairment Detection

Cable operators monitor the use of the spectrum for every device (e.g. cable modem). Such measurements give a state of the communication between the network infrastructure and the device.

The goal of this method is to automatically characterize these spectra by labeling all their impairments. This is instrumental to: 1) Assess the performance of the RF spectrum, 2) Consider variation over time and temperature; 3) Standardize automation & detection of anomalies, and 4) Remove subjectivity and manual interpretation by technicians.

Experts have identified 15 impairments for which automatic detection would bring a competitive advantage. Each of these impairments exhibits an identified cause, and is linked to a repair action that improves the performance of the RF spectrum. For example:

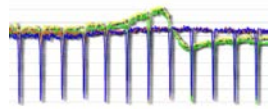

is a *resonance peaking* caused by an amplifier problem

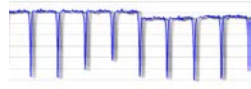

is an *adjacency/alignment* caused by a head-end problem

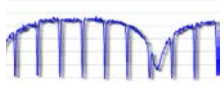

is a *suck-out* caused by an in-home problem

Figure 7 – A few RF spectrum impairment samples

The 15 plant-related impairments ripe for detection and subsequent correction include: Suck-outs, Notches, Tilt (and direction), Ripples / Waves, Off-Air Ingress, Foreign carriers, Wideband / Edison, Roll-off, Resonance / Peaking, Filters, Leveling, Adjacency / Alignment, Power Summary, Distortion / Intermodulation, and Pilot-to-Channel ratio.

6. Design Approaches

The accuracy of the spectral impairment detector currently in production is low, with only 5 impairments being detected. The new impairment detection described is significantly more accurate, targeting the detection of 10 of the 15 known impairments.

In order to enhance the accuracy of spectral impairments interpretation two methods are being pursued. Each of them will result in a much higher impairment classification accuracy.

Mathematical modeling: Spectral data is modeled through traditional signal processing methods, extracting features characterizing each of the 15 impairments in a direct, static mapping.

ML models: An ML algorithm learns dynamic mappings between the features extracted by the mathematical model and the impairments. As such, ML uncovers optimal solutions, fine-tuning each

feature to its best use within a context. This comes at the cost of labeling huge quantities of data to perform the supervised learning. Addressing this issue, the team built a labeling engine in order to crowd-source labeling within Comcast.

6.1. Mathematical Modeling

Each of the impairments described in the figures below are detected by a corresponding set of features.

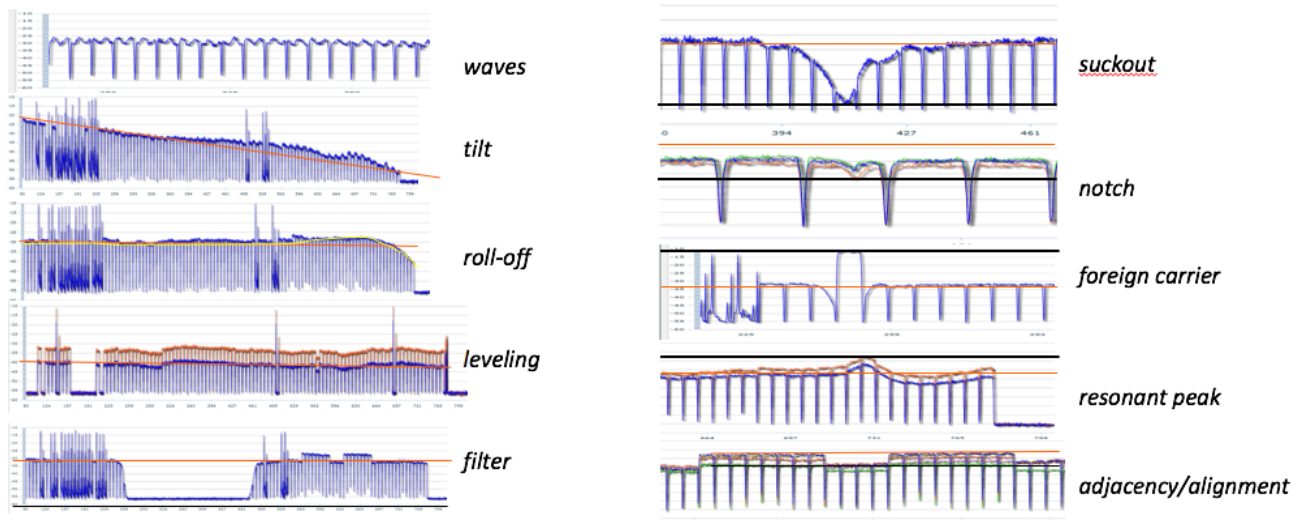
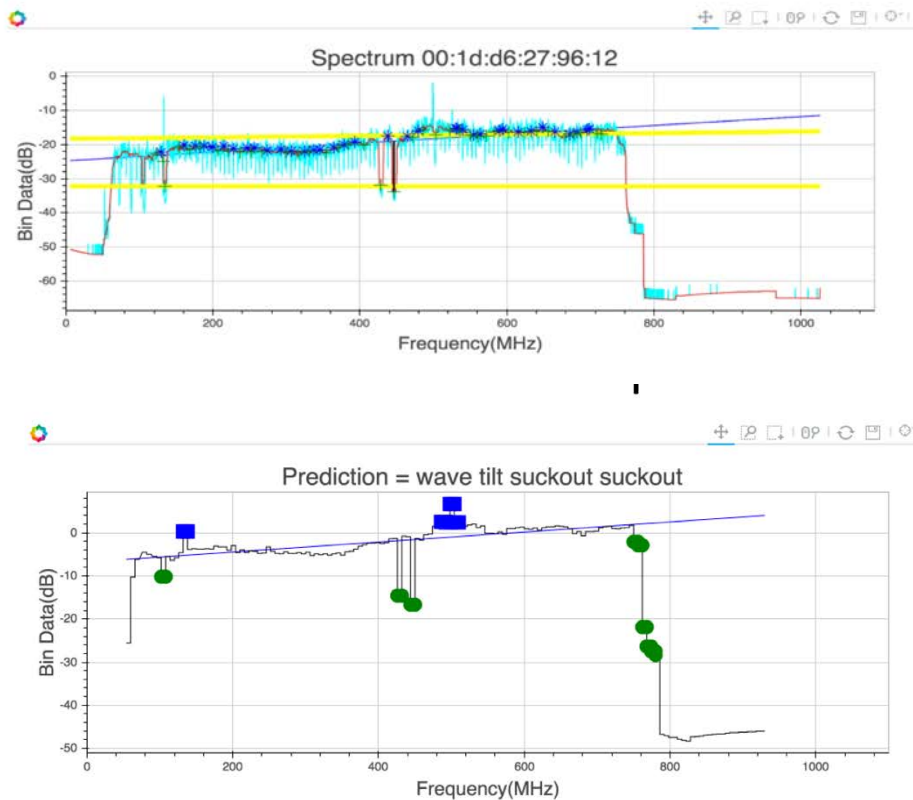

Figure 8 – Spectral impairments and their shapes

Some of the impairments, like roll-off, filters or suck-outs are very impactful to end customers, even preventing them from accessing some channels. Other impairments, like waves, off-air-ingress or tilt slow transmissions down. All of these impairments are linked to known causes. Their diagnostic is key to the performance of Comcast's operations, and is of particular use to field technicians, because it allows them to pinpoint the cause of poor performance, or installation malfunctions.

The proposed approach is based on noise-resistant feature detection. Two data representations are used in parallel. The spectrum representation uses the complete spectrum, with a sampling at 117 kHz. The channel representation characterizes each TV channel which corresponds to a 6 MHz sampling. Channel representation is used and well understood by technicians.



Spectrum

Represents complete spectrum by samples of 117kHz

Channels

Represents each channel of 6MHz

Figure 9 – Spectrum, channels and features

The features are independent from each other and are oblivious to the frequency at which they appear, and their combination allows detection of impairments. Impairment detection methods are also independent from each other, allowing their results to be combined. Thus, this overall detection method allows fine tuning both features and impairments, independently. This flexibility permits the introduction of new features, as well as new methods for impairment detection, without affecting existing detection methods.

6.1.1. Feature Detection

The program extracts similar features for both channel and spectral representations.

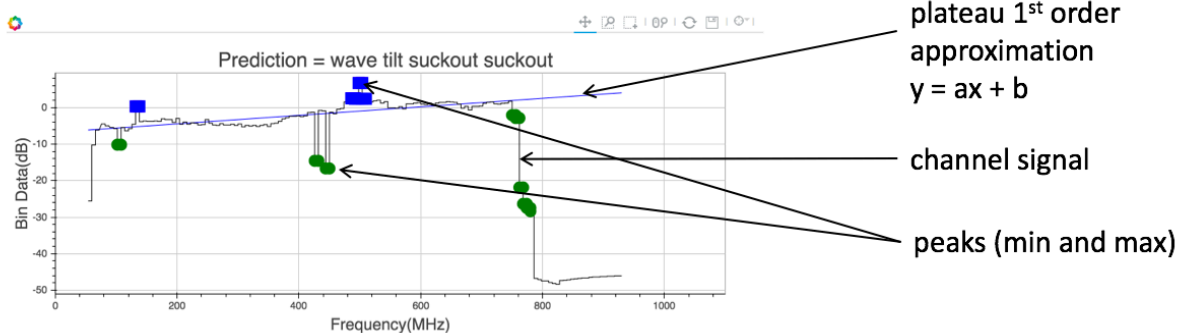

Figure 10 – Feature Detection

A plateau, with frequencies between 120MHz and 750MHz, is considered for the analysis. A linear approximation of this plateau offers stable features $y = ax + b$ to assess the flatness of the plateau and its height. A similar approach is undertaken with higher degree approximations of the same plateau. From this plateau, positive and negative peaks are detected. The shape around these peaks is an important feature, as some of the peaks are formed by single channels, whereas others have parabolic shapes --illustrating that many channels are affected simultaneously.

6.1.2. Example of impairment detection: Tilt and roll-off

A tilt is well approximated by a linear signal. The roll-off, in contrast, shows a fast decrease of the signal amplitude at high frequencies, and is better modeled as a parabola.

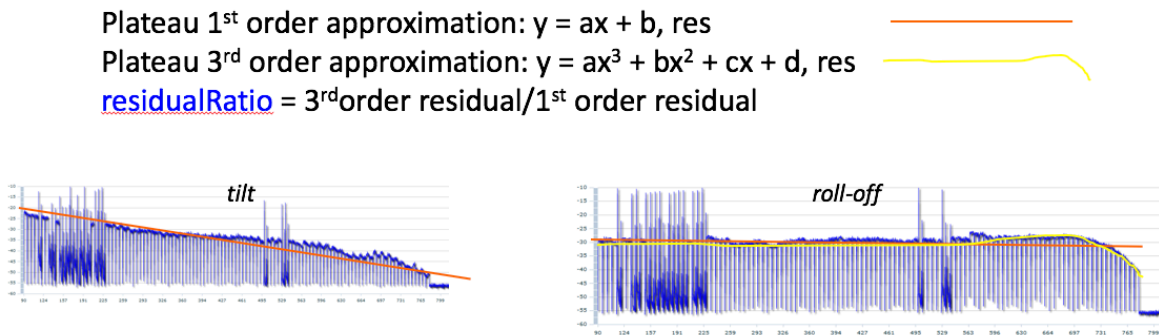

Figure 11 – Tilt and Roll-off detection

One solution differentiating a tilt from a roll-off is to make the ratio between the residuals of the 3rd order approximation and the 1st order approximation. If the ratio is near to 1, the impairment is a tilt since no fast decrease of the signal amplitude at high frequencies was detected.

Example of impairment detection: Suckout, notch, foreign carrier, resonant peak

From a feature extraction point of view, suckout and notch impairments are seen as signal dips, whereas foreign carrier and resonant peaks represent crests in the signal amplitude.

Plateau 1st order approximation: $y = ax + b$
 $d = \text{vertical distance peak depth/height to plateau}$

If $d < 0$
 then *suckout* or *notch*
 else
 foreign carrier or resonant peaking

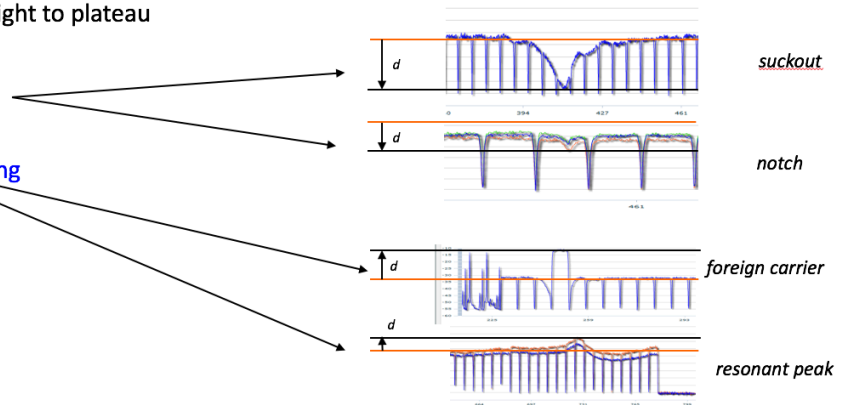

Figure 12 – Suckout, notch, foreign carrier and resonant peaking classification

The suckout is a large dip spanning several channels, whereas the notch is a tiny dip that cannot be seen in the channel view.

The foreign carrier is a sharp, single channel peak in the signal, whereas the resonant peak is a shallow peak spanning across several channels.

6.1.3. Results

The presented method returns a complete impairment diagnostic including all impairment instances detected on a spectral signal.

In the figure below, the presented method discovers a combination of wave, tilt, suckout at 429MHz, and suck-out at 445MHz. In the figure, suckouts are annotated with a red cross-circle:

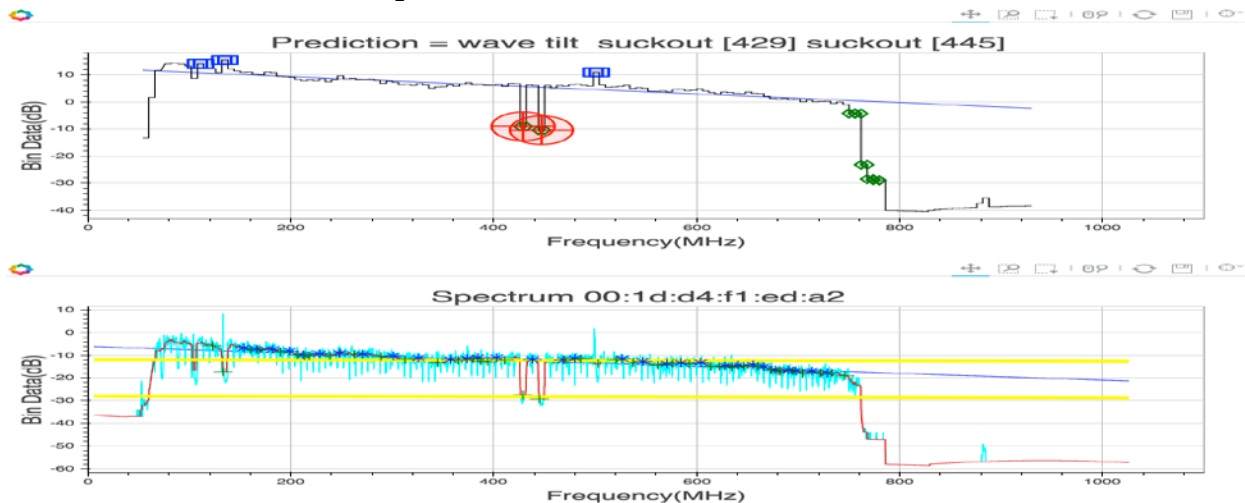

Figure 13 – Prediction example – wave, tilt and suckout

One of the advantages of this mathematical modeling is its simplicity: Each of the impairments is linked to a few features extracted via signal processing. The fine tuning of these features warrants some experimentation and skills, e.g. for defining the threshold making the difference between the tilt and the

roll-off. These parameters are largely independent and can be fine-tuned independently. But static tuning might not be the optimal solution...

6.2. ML Models: Towards an Optimal Solution

ML models can be used to bring mathematical models into a new dimension. Instead of having a finely tuned mathematical model working with static parameters -- like the threshold making the difference between the tilt and the roll-off -- imagine having an ML algorithm that *dynamically* fine tunes these parameters, according to the expected output. The great advantage of ML is that it uses algorithms such as linear regression and classifications to determine the best parameter settings. ML is capable of optimizing thousands of parameters that are far beyond the capabilities of what humans can fine-tune.

However, ML comes at a huge cost in this setting. ML works best in supervised learning, so, data needs be labeled. The features that were treated independently in the mathematical model are now mixed together, leading to a combinatorial explosion. Labeling 15 features into 6 buckets (e.g. none, tiny, small, medium, large, hug) leads to 15^6 possibilities = 11 million to hit each bucket at least once. This domain is most probably sparsely populated, however, this simple calculation shows that labeling data is a daunting task, way beyond human capabilities. At a first glance, hundreds of thousands of labeled data could and should be generated.

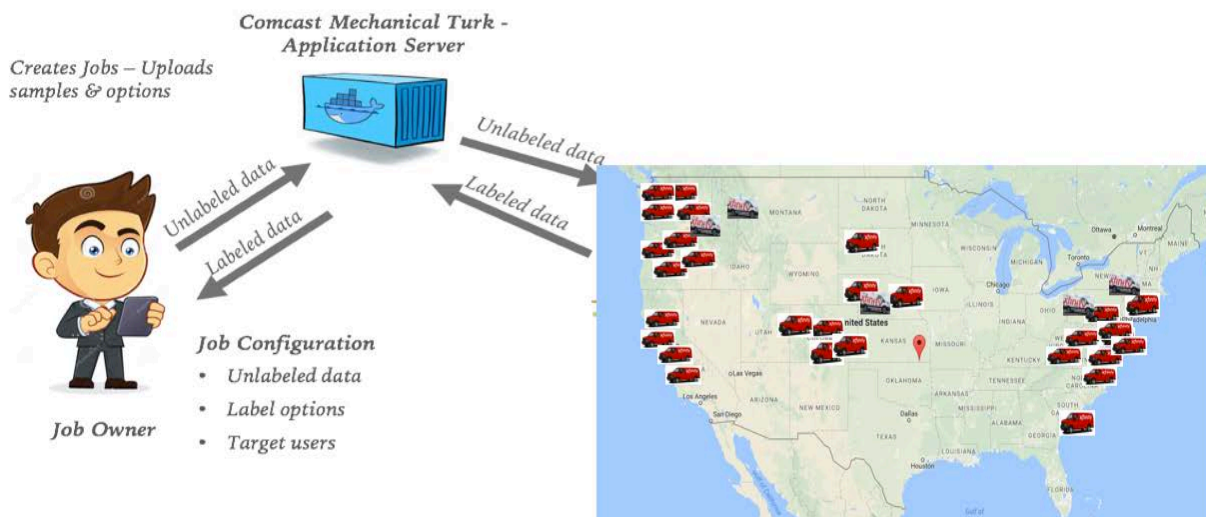

Figure 14 – Comcast Labeling Machine solution overview

The good news is, Comcast and other, like-minded MSOs have thousands of experts in the field capable of labeling this data. These are our industry's technicians. The idea is to farm the labeling task out through a "Turk mechanism" [6]. In this case, the unlabeled data is provided to the Comcast Mechanical Turk server that crowd-sources the data to be labeled to the technicians. At any time, an underutilized technician can access data and label it, through an application programming interface (API) accessed by an app on their mobile device.

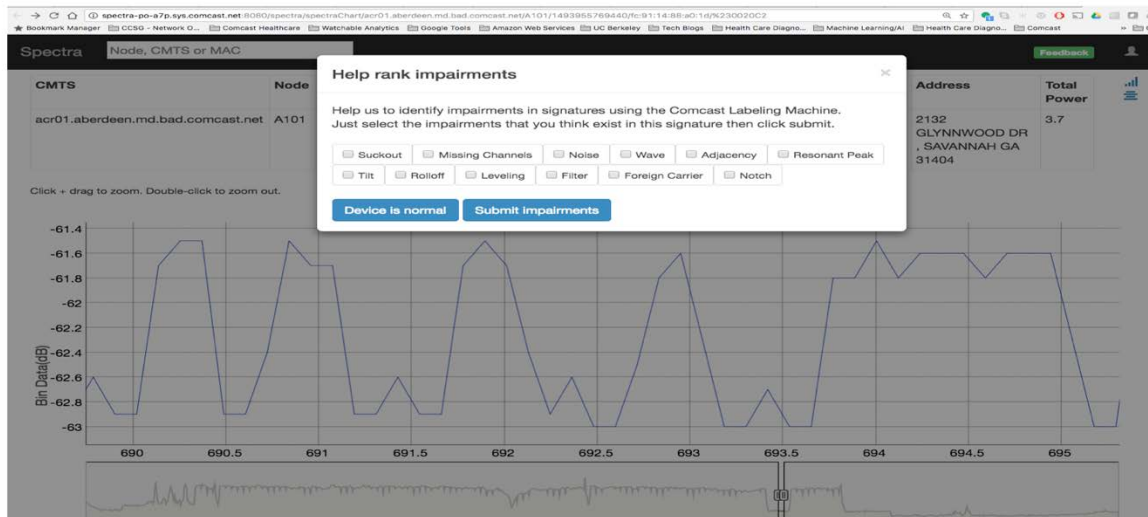

Figure 15 – Comcast Labeling Machine – Labeling impairments

The graphic interface shown above allows a quick annotation, prior to sending the data back to the labeling Turk. The same data can be labeled independently by several technicians to improve the label quality through a vote or an averaging process. The collected data can be reviewed at the labeling engine prior to sending it to the ML algorithm.

Conclusion and Recommendations

Comcast and similar service provider companies have a lot to gain through the applications of machine learning, especially in the area of improving operational efficiencies.

A key takeaway from this paper are the concepts of machine learning as they relate to multiple service operators. Especially important is the new paradigm under which machine learning operates – that of probabilistic expectations and the move away from determinism.

“The best is the enemy of the good”.

The search for answers that are a hundred percent guaranteed to be true can stifle our ability to be successful because it makes us resistant to innovative approaches to problem solving, such as machine learning. Machine learning provides us not just an answer but also the probability associated with the outcome. We, as cable operators, should begin to appreciate the value of such results and have processes that can educate folks on how to use this information. Only then, can we reap the true benefits of machine learning.

This paper also looked at how spectral impairments in the RF spectrum can be predicted using two approaches, one based on straight-forward mathematical modeling and another based on machine learning. Mathematical modeling is similar to a rule-based approach where patterns in the RF spectrum are predicted based on how well they fit certain mathematical functions. The mathematical functions are built using one or more observations. The main drawback of the mathematical model is its inability to scale to accommodate a larger set of representative spectral impairment patterns. Machine learning trains numerous sets of labeled spectral impairment observations and uses this method to build a model for spectral impairment detection. It can also leverage the feature selection work done using the

mathematical model. Given the vast amount of training data that the machine learning model has seen, it is able to better discern subtle differences in spectral waveforms and consequently leads to better predictions. In addition, it is much more maintainable than the mathematical modeling approach since learning to identify a new spectral impairment is simply a matter of adding the new spectral impairment data to the training set and rebuilding the model. The mathematical modeling approach on the other hand is harder to maintain because it requires an expert to generate new functions to recognize the new impairment.

Both the mathematical model and the machine learning model can nicely coexist, with the predictions that they each make serving to contribute to reinforce the overall prediction accuracy.

Abbreviations and Definitions

Term	Definition
AI	Artificial Intelligence
CNN	Convolutional Neural Network – A type of neural net that has been very successful in image classification
DOCSIS	Data Over Cable System Interface Specification – The protocol used to carry data traffic over cable infrastructure
ML	Machine Learning
MSO	Multiple Service Operators – typically refers to cable providers
PCA	Principal Component Analysis – A type of machine learning algorithm used for feature transformation
RF	Radio Frequency
SVM	Support Vector Model – A type of machine learning algorithm used for classification

Bibliography & References

1. The Singularity is Near, By Ray Kurzweil, ISBN - 9780715635612
2. Declining storage costs, mkomo.com, **URL:** <http://www.mkomo.com/cost-per-gigabyte>
3. Statistical Modeling: The Two Cultures, Leo Breiman , **URL:** <https://projecteuclid.org/euclid.ss/1009213726>
4. Gauss-Markov assumptions for linear regression models, **URL:** https://en.wikipedia.org/wiki/Gauss%E2%80%A9Markov_theorem
5. The Netflix Prize, **URL:** <http://www.netflixprize.com/>
6. Amazon Mechanical Turk, **URL:** <https://www.mturk.com/mturk/welcome>

EPON ARCHITECTURE CONSIDERATIONS FOR INTENT- BASED NETWORKING

A Technical Paper prepared for SCTE•ISBE by

Sebnem Ozer, Ph.D., Principal Architect, COMCAST, SCTE/ISBE Member
1701 JFK Blvd
Philadelphia, 19103
sebnem_ozero@comcast.com
215-286-8890

Nagesh Nandiraju, Ph.D., Senior Director, COMCAST, SCTE/ISBE Member
1701 JFK Blvd
Philadelphia, 19103
nagesh_nandiraju@comcast.com
215-286-1941

Table of Contents

Title	Page Number
Table of Contents _____	88
1. Introduction _____	89
2. Intent-based Networking _____	89
3. Distributed EPON Access Architecture _____	89
3.1. SDN/NFV/Cloud Enabled R-OLT Architecture _____	89
4. Conclusions _____	93
5. Abbreviations and Definitions _____	93
5.1. Abbreviations _____	93
6. Bibliography and References _____	94

List of Figures

Title	Page Number
Figure 1 – Example R-OLT Architecture: Disaggregated Functionality	92
Figure 2 – Example R-OLT Architecture with IBN: Location of Network Components	92

1. Introduction

Many service providers have been transitioning into a new service delivery architecture between the subscriber sites and cloud platforms. Intent-based networking (IBN), software defined networking (SDN), network function virtualization (NFV), cloud based applications and all-IP delivery systems are the terms widely used in this new approach. The migration strategy (what technology, why, when and where to adopt) depends on the existing deployments and architectures, the business targets and priorities specific to the service provider. However, the common objectives are reducing the cost, offering 4As (any content, on any device, anytime, anywhere) with best quality of experience and generating new revenue areas. This paper will discuss an Ethernet passive optical network (EPON)-based distributed access architecture controlled by an access agnostic orchestration platform to achieve these common goals. While we use a PON-based architecture as an example, these concepts can be applied to any last mile access technology.

2. Intent-based Networking

There are multiple projects and proposals on policy and intent-based networking (IBN) within the standards and open source groups with contributions from both operators and vendors. In this approach, the applications consuming network services describe what they want through northbound interfaces and protocols to the orchestration/controller platform. For example, the intent may be a service between two entities with low latency requirement. The orchestration and controller platform translates it into rules, which are further expressed as commands and actions for several physical and virtual network functionality (PNF and VNF) components that form the service delivery system. The control plane (how to deliver) is abstracted from the application plane (what business policy to deliver). The control plane must have the visibility of the underlay network that can be provisioned, programmed and updated to deliver the requested policy with continuous service assurance validation. Such a system would provide service agility for the 4As (any content, anywhere, anytime and on any device), open new revenue opportunities, and improve operations. Automation and programmability are key features for IBNs.

3. Distributed EPON Access Architecture

EPON is a future-proof fiber-to-the-home-based access technology for all-IP service delivery. Today's EPON is mature at 10G symmetrical, and there is ongoing standardization work for higher data rates up to 100Gbps symmetrical. A remote optical line terminal (R-OLT) architecture with physical layer (PHY) and medium access control (MAC) functionality distributed deep in the network has benefits of supporting long reach between serving groups and headend/hub locations, a high split ratio and better fiber efficiency by using wavelength division multiplexing optics [1]. One of the unique benefits of the R-OLT architecture is the deployment flexibility as different number of EPON ports and network-to-network interface ports can be activated and mapped based on the serving group changes over time. 5G backhaul and some internet of things (IoT) applications require very low latency performance, which can be supported by remote architecture.

3.1. SDN/NFV/Cloud Enabled R-OLT Architecture

Figure 1 displays an example R-OLT architecture with disaggregated functionality. Today's widely used EPON chips include PHY, MAC and upstream dynamic bandwidth allocation functionality in a single silicon on chip. Having this functionality distributed improves latency performance and offers flexible deployment options. Traffic management (e.g. downstream scheduling, subscriber management filters, some access control lists and source address verification) may also be implemented in the node effectively thanks to low power switches. Small shelf OLTs may be deployed in the hubs and connected to the same switch fabric architecture. While the functionality that exists in

the traditional EPON line cards can be implemented as physically distributed network functionality in the node, others such as routing control protocols may be implemented as virtualized network function (VNF) common to different access technologies. NFV enables distributed software functionality implemented over common hardware.

A programmable open system with standard interfaces and protocols is created through separating data, control and management planes [2]. DOCSIS provisioning over EPON (DPoE) System management and control plane (including all or partial virtual Cable Modem (vCM) functionality) may be implemented as an SDN component to provision and manage R-OLT and optical network units (ONUs) (vDPoE/vCM-M in Figure 1). Similarly, open software (SW) may be used for the routing control plane with connectivity to the core router (vRouter and high availability orchestration platform in Figure 1). Underlay network connecting the R-OLT, VNF servers and the core router is controlled by an SDN controller on the same platform (fabric/underlay controller in Figure 1). All these SW components may reside in the headend and be part of an access agnostic orchestration and controller architecture. With this approach, network intelligence is shifted into a centralized platform with cloud-based applications controlling distributed components implemented as microservices on containers or virtual machines. This approach has two main advantages. First, new service and policy workflows may be introduced with customized service chains while subscribers at large scale are supported. Second, functionalities may be created, modified and tested faster with DevOps process.

High availability is crucial for the new architecture. Multiple instances of the same functionality, multiple redundant connections along the data path (from R-OLT to the aggregation switch, within the switch fabric and to the core router) and optimized stateful information storage provide high availability features. Distributed R-OLT architecture and a microservices approach remove single points of failure affecting large serving groups.

An SDN/NFV/cloud-enabled R-OLT architecture provide automation and programmability, two key features for IBNs. Common application programming interfaces (APIs) into programmable physical and virtual network components are provided for automated provisioning, receiving and accessing telemetry and controlling the network actions. Service orchestration as an abstraction layer between application and control plane, telemetry and network provisioning and life cycle management, as shown in Figure 1, have end-to-end visibility and control capability of the distributed SDN features.

1) Onboarding of physical and virtual components

This process may be mainly controlled by PNF and VNF life cycle management (LCM) and configuration management platforms [3]. Each R-OLT port connected to an aggregated switch in the switch fabric is authenticated and the R-OLT is assigned a management IP address through the controller platform applications. The communication between the R-OLT and aggregation switch may be encrypted (e.g. using MACsec). LCM may command the container or virtual machine platform to initiate and assign the DPoE Management SW component for the new R-OLT. Afterwards, DPoE management SW may communicate with the R-OLT over a secure connection. The configuration management platform provides DPoE System/R-OLT and underlay network specific configurations along with run-time and local configuration parameters to provision both the EPON and access-agnostic part of the network. Once the R-OLT is operational, a vCM SW instance is created for each registered ONU and ONUs are provisioned and controlled per DPoE specifications. Corresponding ONU and subscriber information is shared with the LCM platform. One important aspect is the automatic discovery and matching of physical and virtual components. The other important feature is to use configuration templates that can be directed to corresponding components and migrate towards common APIs and Netconf/YANG models without using traditional command line interface (CLI). This is required to support automation for large scale networks, such as the disaggregation of OLTs into logically and physically smaller, distributed components. CLI may still be used for testing and debugging purposes.

In the long term, the orchestration platform can translate abstracted service directives to EPON specific and common platform (such as switch fabric) resources and features (e.g. interface configurations, queue management, forwarding rules).

2) Telemetry and analytics

Centralized telemetry hosted in cloud can provide end-to-end visibility for automated control. Instead of relying only on the traditional pull-based methods such as SNMP with MIB data, push-based monitoring with compact data presentation is preferred [4]. Data collected for different topics may then be streamed into a centralized database via a messaging bus. Logging information is also forwarded towards a centralized platform. Effective dashboarding, visualization and alarm tools using tunable settings are provided using open SW. Data must be tagged in a structured way, collected, and stored through compute and object storage that can scale up and down based on needs. Effective machine learning techniques can process large raw data and correlate them to detect high-level events. Therefore, predictive and proactive maintenance may be supported and automated escalation of issues to specialized support groups may improve customer experience. Dynamic observability and virtual and physical probing enable debugging and troubleshooting through both push and pull based data collection, new service integration and customer QoE assessment. The same system may also be used for business intelligence, network planning and usage based accounting.

3) Dynamic and Adaptive Control

Once the system is operational, services' status must be continuously monitored through the automated telemetry architecture. Resources may be managed based on the analytics to self-optimize or load balance the network. The orchestration layer directs different controllers to program the network where elastic resources can be allocated based on the QoS, scale and network load status. Proactive and predictive maintenance will enable self-healing in the long term. For reactive maintenance issues, automated telemetry may help to effectively redirect to the corresponding expertise level.

Depending on the new serving group and service requirements, new R-OLT PON ports or new R-OLTs may be deployed after the initial deployment. After onboarding process of the new ports and R-OLTs, orchestration and controller platform may scale and adjust resources for both the VNFs and PNFs in an automated way.

Figure 2 shows an example architecture where R-OLT nodes are connected to aggregation switches that may be located in the secondary hubs. These switches are then connected over an optical transport network to the switch fabric in the headend physical POD. Physical PODs include VNFs and PNFs that serve a serving group segment and are connected to core routers. A centralized controller platform, such as Open Network Foundation's ONOS platform, may manage all the corresponding PODs. Higher level orchestration functionality are located in the cloud to manage many regions.

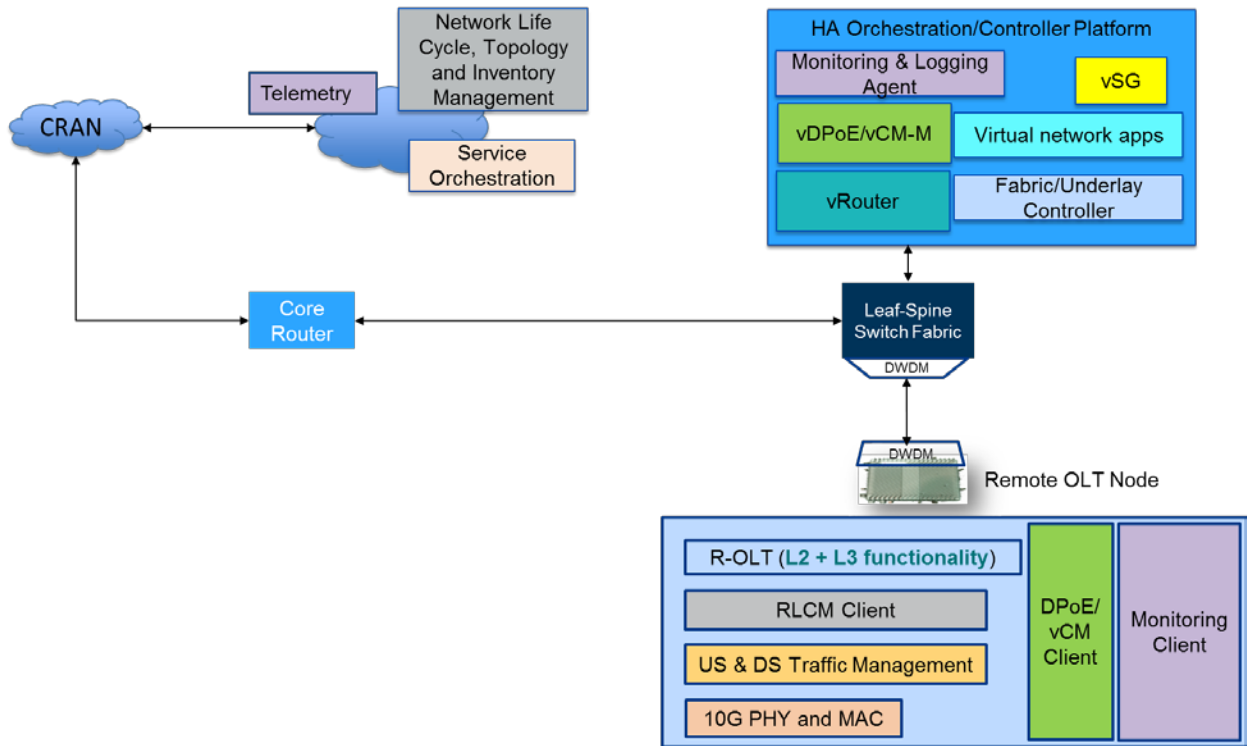

Figure 1 – Example R-OLT Architecture: Disaggregated Functionality

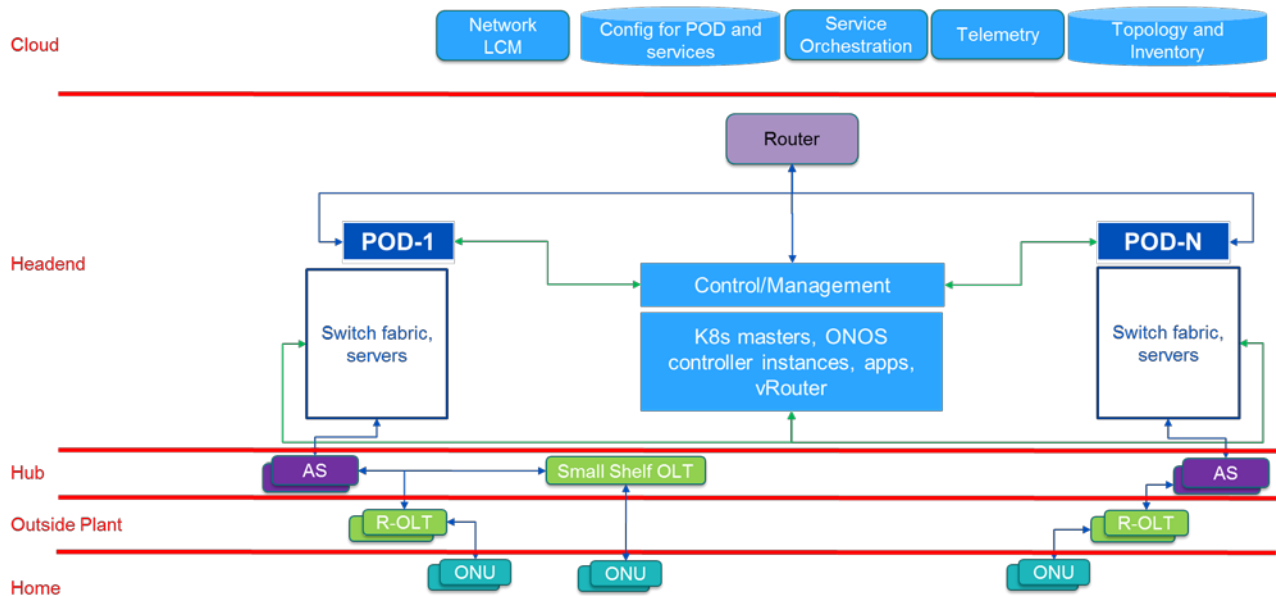

Figure 2 – Example R-OLT Architecture with IBN: Location of Network Components

4. Conclusions

An R-OLT architecture provides future-proof access technology for the fiber-to-the-home last mile. It offers flexible deployment scaling and improved latency performance for emerging applications such as 5G backhaul and low-delay IoT. Intent based networking applied with an SDN/NFV-enabled R-OLT architecture aims to reduce cost, generate new revenue areas and provide better customer satisfaction. Operational costs are reduced through automated operations such as provisioning, telemetry, and end-to-end service assurance with self-optimizing networks. Abstraction of control plane from the application plane will simplify the operations in the long term. Capital expenses may be reduced as well with open source SW on common off-the-shelf hardware (HW) that can be reused. Flexible deployment architectures can scale based on the needs. Service providers may implement faster innovation and try new business opportunities through applications and services that can be integrated quickly while requiring less investment and lower cost of ownership. Better performance and automated service assurance will increase customer quality of experience.

The new architecture requires a well-planned roadmap of disruptive technologies and new ways of design, development, test and operations. Challenges include finding efficient integration and interoperability methods for disaggregated function components supported by different teams in the service provider's company, vendors, open networking groups and integrators.

5. Abbreviations and Definitions

5.1. Abbreviations

AS	aggregation switch
CLI	command line interface
DPoE	DOCSIS provisioning over EPON
EPON	Ethernet passive optical network
HW	hardware
IBN	intent-based networking
IoT	Internet of things
ISBE	International Society of Broadband Experts
MAC	medium access control
MIB	management information base
NFV	network function virtualization
ONU	optical network unit
PHY	physical layer
PNF	physical network functionality
R-OLT	remote optical line terminal
SCTE	Society of Cable Telecommunications Engineers
SDN	software defined networking
SNMP	simple network management protocol
SW	software
vCM	virtual cable modem
VNF	virtualized network function

6. Bibliography and References

[1] *A Comparison of Purpose Built OLT Systems vs. SDN/NFV Systems for PON*, Emmendorfer M. and Ozer S.Z; SCTE-ISBE Workshop 2016

[2] *Delivering Seamless Subscriber Aware Services over Heterogeneous Access Networks using a SDN and NFV Framework*, Nandiraju N., Lee Y. and Salinger J.; NCTA Spring Technical Forum 2015

[3] *Virtualization and Network Evolution Virtual Provisioning Interfaces - Virtual Provisioning Interfaces Technical Report*, CableLabs VNE-TR-VPI-V01-170424

[4] *A-CORD (Analytics for CORD)*, <https://wiki.opencord.org>

An Innovative Design to Drive Spectral Efficiency in DOCSIS FDX beyond 25Gbps

A Technical Paper prepared for SCTE•ISBE by

Xialong Zhang, Senior Engineer, Huawei Technologies Co., LTD.
Optical Valley Software Park, Wuhan, China
Zhangxiaolong66@huawei.com
+86-18062067919

Tao Ouyang, Senior Engineer, Huawei Technologies Co., LTD.
Optical Valley Software Park, Wuhan, China
toy.ouyangtao@huawei.com
+86-18986119812

Syed Rahman, Principal Engineer, Futurewei Technologies Inc. (Huawei R&D USA)
A 2330 Central Expressway, Santa Clara, CA 90050
Syed.R@huawei.com
+1 408-330-4472

James Jeng Chen, Principal Engineer, Futurewei Technologies Inc. (Huawei R&D USA)
A 2330 Central Expressway, Santa Clara, CA 90050
Chen.jim@huawei.com
+1 408-330-4752

Table of Contents

Title	Page Number
Table of Contents _____	96
1. Abstract _____	98
2. Introduction _____	98
3. N+0 HFC Plant Model _____	99
4. Challenges of Extended Spectrum DOCSIS and FDX DOCSIS _____	99
4.1. Challenges of Extended Spectrum DOCSIS _____	99
4.1.1. Coaxial Cable Attenuation at High Frequency _____	99
4.1.2. Tap and Splitter at High Frequency _____	100
4.1.3. Total Path Loss at High Frequency _____	101
4.1.4. High transmit power level of the Node _____	102
4.2. Challenges of FDX DOCSIS _____	103
4.2.1. High Transmit Power at CM _____	103
4.2.2. High Echo Cancellation Requirement at Node _____	104
4.2.3. Limited Noise Floor Cancellation Ability _____	104
5. Solution-1 for spectrum extension using Multiple Spectrum Domain _____	105
5.1. Conception of Multiple Spectrum Domain _____	105
5.2. FDX CM Transmit Power _____	107
5.3. Echo Cancellation Requirement at Node _____	107
5.4. New Echo Cancellation Architecture _____	107
5.5. New Tap Design to Increase Isolation _____	108
6. Solution2: Novel Plant with Duplex Tap _____	108
6.1. Special Duplexer Tap _____	109
6.2. N+0 HFC Plant with Duplex Tap _____	110
6.3. Node Transmit Power for plant using duplexer taps _____	111
6.4. FDX CM Transmit Power with duplexer taps _____	112
6.5. Echo Cancellation Requirement at Node _____	112
7. Comparison of Spectral Extension methods _____	112
8. HFC and DOCSIS Migration Steps _____	113
9. Conclusions _____	113
10. Abbreviations and Definitions _____	114
10.1. Abbreviations _____	114
11. Bibliography and References _____	114

List of Figures

Title	Page Number
Figure 1 – A N+0 Passive HFC Plant	99
Figure 2 – Different Coaxial Cable Attenuation in 100m	100
Figure 3 – Insertion Loss of 1.2GHz and 3GHz Taps	100
Figure 4 – Forward Path Loss of 1.2GHz and 3GHz Tap	101
Figure 5 –Total Path Loss from Node to CM on 1.2GHz Plant	101
Figure 6 –Total Path Loss from Node to CM on 3GHz plant	102
Figure 7 –Transmit power of the Node, for the 3GHz plant	103
Figure 8 – Required Total Transmit Power of FDX CM (2.178~3.138 GHz)	104

Figure 9 – EC Requirement at Node	104
Figure 10 – Current Echo Cancellation Architecture	105
Figure 11 – Total Path Loss from Node to CM on 3GHz Plant	106
Figure 12 – Multiple Spectrum Domain	106
Figure 13 – Echo Level at Node for 3 GHz FDX system	107
Figure 14 – New EC Architecture	108
Figure 15 – New Tap Design to Increase Isolation	108
Figure 16 – Duplexer Tap 426 (type 1)	109
Figure 17 –Duplexer Tap 423 (type 2)	109
Figure 18 –N+0 HFC plant with duplexer taps	110
Figure 19 – Equivalent Diagram of the New N+0 HFC Plant	110
Figure 20 – Path Loss from Node to CM	111
Figure 21 – Node Transmit Power	111
Figure 22 – Echo Cancellation Requirement at Node	112
Figure 23 – HFC and DOCSIS possible migration steps	113

List of Tables

Title	Page Number
Table 1 – Multiple Spectrum Domain	106
Table 2 – FDX CM TCP in 3GHz system	107
Table 3 – FDX CM TCP in 3GHz system with duplexer tap	112

1. Abstract

The deployment of DOCSIS3.1 is already underway and will accelerate to a rapid pace in the coming years. The current DOCSIS3.1 technology is likely to meet MSO's requirements for some more years. However, the ever increasing appetite for more and more bandwidth, especially in the upstream, makes it essential to start looking for next generation technologies beyond DOCSIS3.1. At present, there are two important next generation cable technologies that can increase the cable capacity: 1) Expanding the coaxial cable spectrum 3 GHz and moving cable to 25Gbps era. 2) Using Full Duplex (FDX) for symmetrical downstream/upstream capacity. This paper analyzes the major challenges of spectrum expanding and full duplex at high frequency for the passive HFC plant. An innovative design is introduced to expand the DOCSIS spectrum to 3GHz and preserve cable HFC node for operating FDX DOCSIS in higher spectrum. The proposed design solves the issue of excessive power attenuation at higher spectrum and greatly reduces the required transmit power of the CMs operating in FDX mode to achieve a rate of 10Gbps for upstream and 25Gbps for downstream.

2. Introduction

The current FDX DOCSIS can only work for an N+0 (Node plus zero amplifier) HFC plant. This paper focuses on the N+0 plant, and shows how to utilize the extended spectrum along with FDX technology to achieve a rate of 10Gbps for upstream and 25Gbps for downstream..

Following are the major challenges for expanding the spectrum to 3 GHz for an N+ 0 plant based on conventional coax design rules; 1) the current 1GHz tap has to be replaced with a newly designed tap to support 3GHz spectrum. 2) The Node transmit power has to be increased by tens of dBs, to overcome the huge increase in cable loss at higher frequencies. 3) The transmit tilt will increase from 20dB to 40dB or more, requiring excellent DAC and power amplifier with lower noise floor.

In FDX DOCSIS, the downstream and upstream signals occupy the same frequencies on the passive coax network. The challenge for FDX DOCSIS is to separate the downstream and upstream signals. There are three key methods to achieve this task; 1) Echo Cancellation (EC) at the Fiber Node, 2) CM-to-CM Interference mitigation through resource scheduling, and 3) Adjacent leakage interference cancellation at CM.

FDX DOCSIS is planned to operate at the lower end of the downstream spectrum from 108MHz to 684MHz. The advantages of using lower frequency for FDX operation are; 1) the higher return loss of taps at lower frequencies, results in lower echo levels at the Node, reducing the Echo cancellation requirements of the Node. 2) The higher isolation of taps at lower frequencies, results in lower CM-to-CM interference which can be effectively mitigated through RF resource scheduling.

Operation of FDX DOCSIS at higher frequencies introduces the following challenges; 1) the higher cable loss at higher frequencies mandates higher downstream signal power. This higher downstream signal power results in very high echo levels, increasing the Echo cancellation requirements at the Node significantly. 2) The lower return loss of taps at higher frequencies, increases the echo levels even more. 3) It is difficult to cancel the noise floor in each signal with current EC architecture.

Without an innovative architecture, the possibility of operating FDX DOCSIS at higher frequencies is very limited.

This paper explores, usage of extended spectrum for both DOCSIS, and FDX DOCSIS, using an innovative architecture and design. Section 3 describes a typical N+0 passive HFC plant model. Section 4 discusses the challenges and problems of operating DOCSIS in extended spectrum range. Section 5 provides a solution for operating DOCSIS in extended spectrum range. Section 6 proposes a new tap design as another solution for spectrum extension. The proposed tap splits the downstream signal into different spectrum bands, each with a different tap loss. The issue of higher

cable loss at higher frequencies can be mitigated by allocating the lower spectrum bands to CMs which are farthest away from the Node. Section 7 compares the different solutions proposed for spectral extension. Section 8 discusses the “long term evolution” for the cable industry, involving the extended spectrum DOCSIS and FDX DOCSIS. Section 9 concludes the paper by summarizing the key requirements and solutions for making extended spectrum DOCSIS and extended spectrum FDX DOCSIS a reality.

3. N+0 HFC Plant Model

The FDX DOCSIS assumes the N+0 HFC plant model. This paper uses a typical N+0 HFC plant to discuss the key technologies of extended spectrum DOCSIS, and FDX DOCSIS operating at higher spectrum.

A typical N+0 coax network has 5 to 6 taps with 75 to 175ft trunk cable spacing, the trunk cable type is or similar QR540 hardline. Each tap is connected to four or eight (typically four) homes through the drop cable. Figure 1 shows a typical N+0 HFC plant model with 6 taps. The spacing between taps is 175ft, and each drop cable is 100ft RG6 type cable. The model will be analyzed in the followed sections.

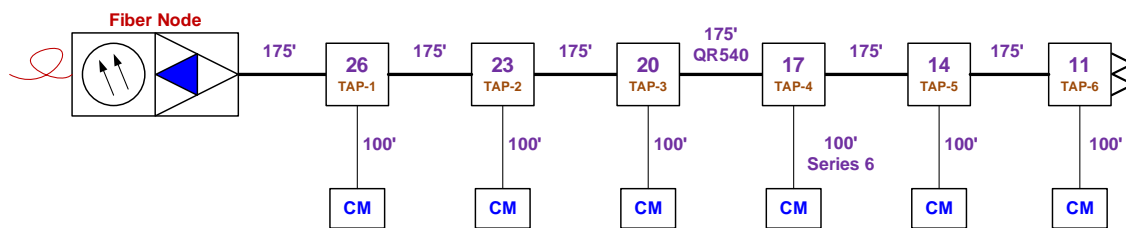

Figure 1 – A N+0 Passive HFC Plant

4. Challenges of Extended Spectrum DOCSIS and FDX DOCSIS

4.1. Challenges of Extended Spectrum DOCSIS

Extended spectrum is one of the top potential next generation technologies for cable industry. It is a straight forward method of increasing the capacity by simply extending the radio frequency spectrum. However, the key question is, what is the realistic limit of extended spectrum is? In NCTA2016, Arris claimed the cable spectrum may be extended to 6GHz, 12GHz and beyond in the future. But, it is a long way to realize these limits of extended spectrum because of several limitations of the cable plant discussed below.

4.1.1. Coaxial Cable Attenuation at High Frequency

The attenuation of the cable is directly proportional to the length of the cable and the frequency of the signal. Figure 2 shows the attenuation per 100 meters of trunk cable “QR540” and drop cable “RG6”. As seen in the figure, at 1GHz the attenuation of trunk cable is less than 8dB/100m and the attenuation of drop cable is less than 22dB/100m. Compared to the attenuation values at 1 GHz, the attenuation values at 3 GHz are roughly 5 dB/100 m higher for the trunk cable and roughly 16 dB/100 m higher for the drop cable. For example, for a trunk cable length of 300 meters, the attenuation at 3 GHz compared to 1 GHz, will be roughly 15 dB higher, and for a drop cable length of 30 meters the attenuation will be roughly 5 dB higher.

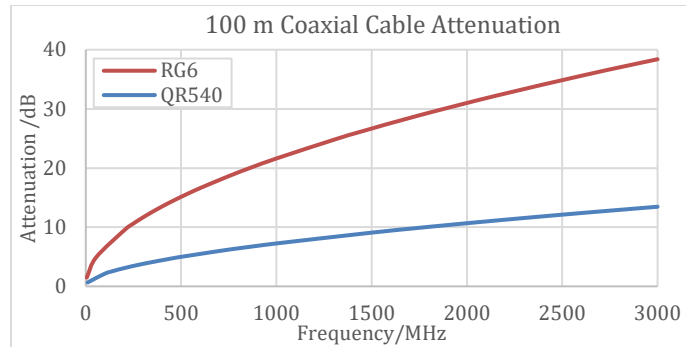

Figure 2 – Different Coaxial Cable Attenuation in 100m

4.1.2. Tap and Splitter at High Frequency

There are many types of taps and splitters available for the cable industry. Currently the frequency limit of these components is around 1GHz. With deployment of DOCSIS3.1, some taps and splitters will soon support 1.2GHz or 1.8GHz. The frequency limit for 75 ohm taps or splitters, found in the industry is around 3GHz. But these products are mainly used in indoor distribution network for the drop cable. Based on the indoor tap, Huawei has conducted lab research and developed a 3GHz trunk tap with the following key modifications: 1) the magnetic core is changed to improve the inductance value at high frequencies. 2) A new tap containment structure is designed to meet the electromagnetic shielding performance requirements at high frequencies.

Figure 3 shows the insertion loss of currently available 1.2GHz tap (left plot) and Huawei's 3GHz tap prototype (right plot).

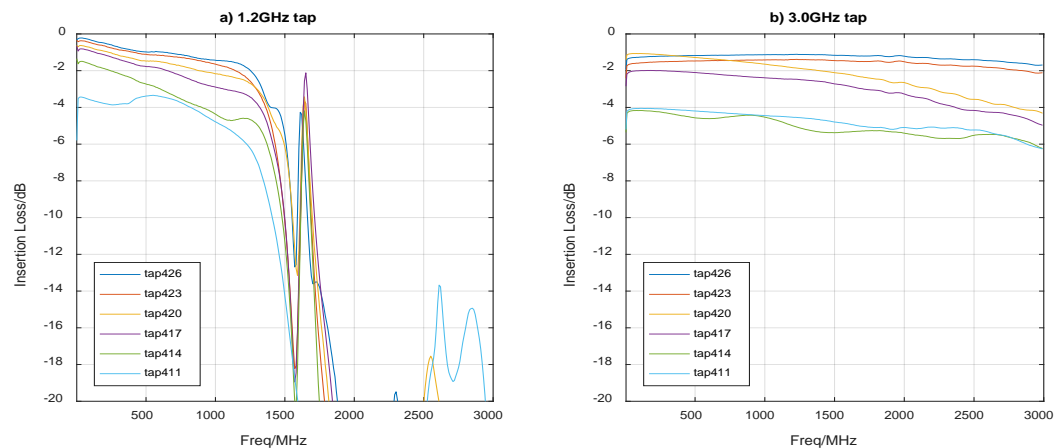

Figure 3 – Insertion Loss of 1.2GHz and 3GHz Taps

For the conventional 1.2GHz tap, there is a roll off beyond 1.2GHz, while for the 3GHz tap, the insertion loss curve is almost flat up to 3GHz.

Figure: 4 shows the forward path loss of the conventional 1.2 GHz tap (left plot) and Huawei's 3 GHz tap prototype (right plot).

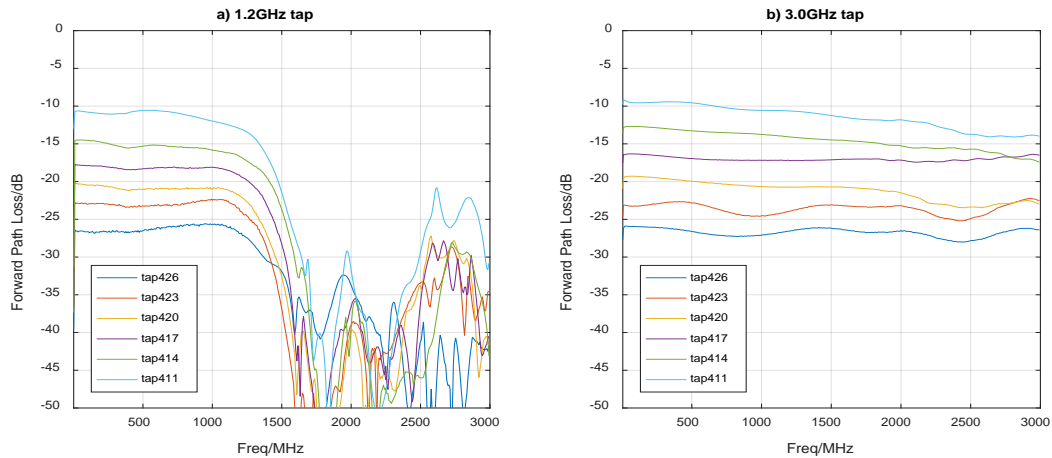

Figure 4 – Forward Path Loss of 1.2GHz and 3GHz Tap

With better processing techniques and materials, the 3 GHz tap performance can be further improved yielding; lower insertion loss, flat forward path loss, higher isolation, and lower return loss. These factors can be considered to improve the tap design in the further: 1) For the N+0 plant, the current may not pass through the tap, so it can simplify the design of the tap. 2) The type of junctions at the tap plate can be changed like the N-connectors, the stinger and the female socket can contact more close. It will reduce the path loss and improve the return loss.

4.1.3. Total Path Loss at High Frequency

Figure 5 shows the total path loss from Node to CM of a typical N+0 HFC plant using the widely used 1.2 GHz outdoor tap.

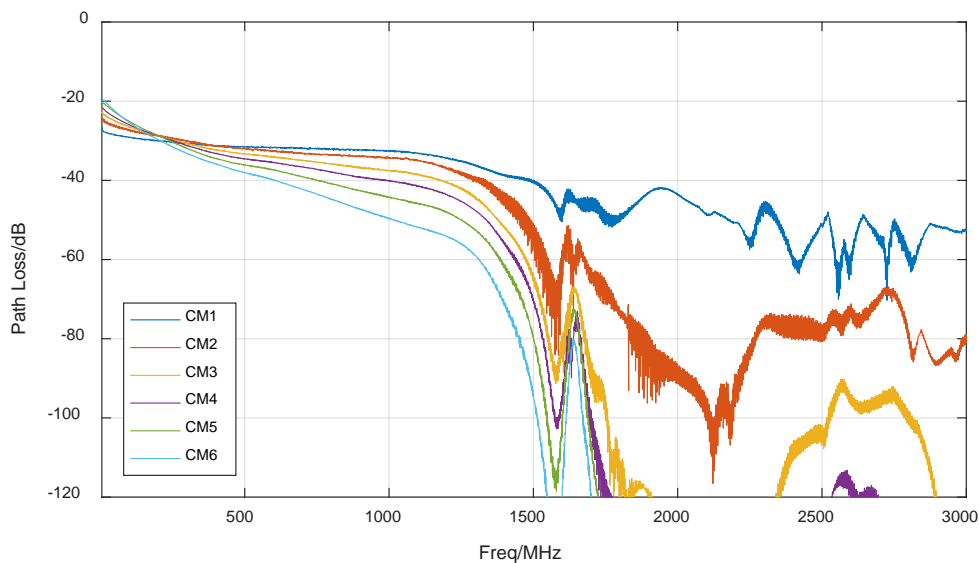

Figure 5 –Total Path Loss from Node to CM on 1.2GHz Plant

As seen from the figure, this network cannot work beyond 1.2 GHz, due to excessive total path loss.

For N+0 HFC network to operate at 3GHz, the traditional spectrum extension method involves replacement of all 1.2GHz taps by 3GHz taps. Figure: 6 shows the total path loss from the node to each CM using 3 GHz taps.

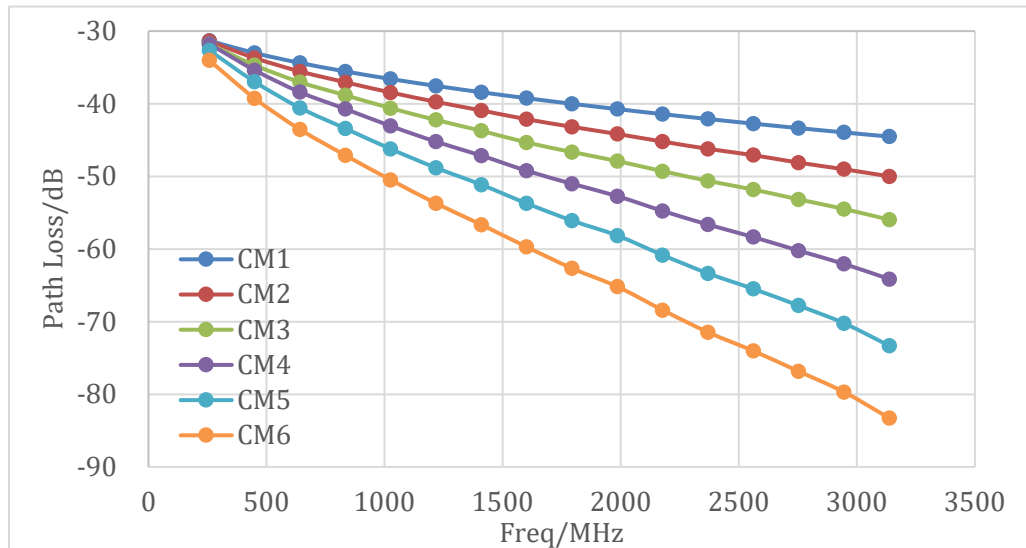

Figure 6 –Total Path Loss from Node to CM on 3GHz plant

As seen in the figure, even with 3GHz taps, the path loss at 3GHz is very high for the last three CMs (CM4, CM5 and CM6).

4.1.4. High transmit power level of the Node

To assure proper reception of data by all CMs at all frequencies, the Node should consider the worst case path loss, such as the path loss of CM6 shown in Figure 6. Then, different Equalizations and attenuations can be used in the taps, so that each CM receives the same flat received power level, such as 3dBmV/6MHz.

Figure 7 shows the transmit power spectral density (PSD) of the Node for a N+0 HFC plant operating with 3 GHz extended spectrum. The total transmit power of the node is about 102.6dBmV. Which is 27.6 dB more than current maximum transmit power of 75dBmV, and unacceptable.

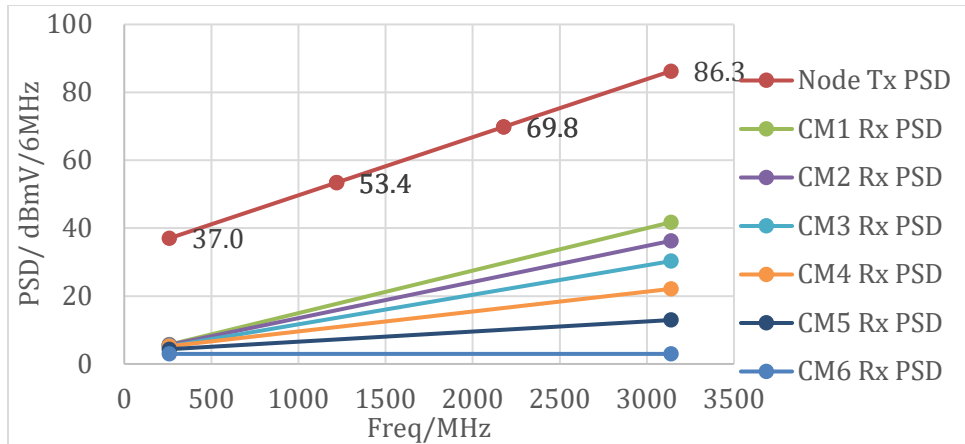

Figure 7 –Transmit power of the Node, for the 3GHz plant

Another more feasible method to reduce the transmit power of node is using the power step-down method. But it will reduce the bit loading at high frequency, and reduce the total network bandwidth.

4.2. Challenges of FDX DOCSIS

High signal quality in FDX is preserved using the following key techniques; 1) Echo cancellation at the node, 2) CM-to-CM interference reduction via interference group (IG) discovery and resource scheduling, and 3) adjacent channel interference (ACI) and adjacent leakage interference (ALI) reduction at CM.

To maintain low levels of echoes and interferences, FDX DOCSIS is planned to operate at the lower end of the downstream spectrum from 108MHz to 684MHz. Operating FDX at very high frequencies of the extended spectrum introduces daunting challenges described below.

4.2.1. High Transmit Power at CM

In FDX, the upstream frequency range is extended to overlap the downstream frequencies. The required total transmit power of the CM at these higher frequencies is calculated using the following assumptions; 1) The HFC plant is a typical N+0 plant shown in Figure 1 and the total path loss is as shown in Figure 6. 2) The extended spectrum range from 1.218 to 3GHz can be separated into 10 OFDM channels with bandwidth 192MHz. The last 5 OFDM channels between 2.178 to 3.138 GHz are selected as operating frequency range for the FDX CM. 3) the required upstream received power level at the node is 0dBmV/6MHz.

Figure 8 shows the transmit power of the CMs required to occupy the spectrum band 2.178 to 3.138 GHz, computed using the above assumptions. As seen from the figure, except CM1, the transmit power of all other CMs exceeds the maximum specified CM transmit power of 65 dBmV. The transmit power of CM6 exceeds the maximum limit by 25 dB.

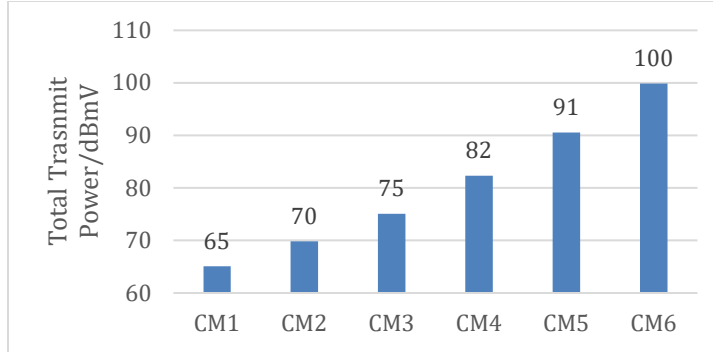

Figure 8 – Required Total Transmit Power of FDX CM (2.178~3.138 GHz)

4.2.2. High Echo Cancellation Requirement at Node

The echo level at the node is computed using the following assumptions; 1) the downstream transmit power of the node is as shown in figure 7, yielding a downstream SNR of 50dB. The noise floor in the downstream is introduced mainly by the power amplifier (PA) [1]. 2) Upstream target receive power is 0dBmV/6MHz, and upstream SNR is 40dB. 3) Echo level from the DS to US is about 25dB@108MHz, to 10dB@3138MHz.

Figure 9 shows the echo level and noise floor along with upstream receive power and noise floor using the above assumptions.

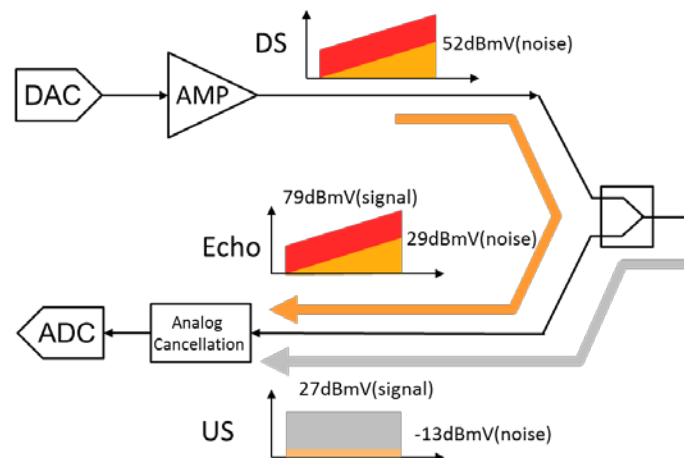

Figure 9 – EC Requirement at Node

To get a minimum SNR as 35dB for the US signal, from the TCP of signal and noise floor, the echo cancellation ability should reach $79 - (-13 + (40 - 35)) = 87\text{dB}$ (excepting for the isolation of duplexer), this should be finished by analog and digital cancellation in the fiber node, while for current FDX DOCSIS system working at 108~684MHz, the cancellation ability just need 55~60dB. Due to the limitation of current echo cancellation architecture, it is very difficult for the node to cancel up to 30dB more.

4.2.3. Limited Noise Floor Cancellation Ability

Figure 10 shows the current state of the art echo cancellation architecture. The noise floor in the downstream is introduced mainly by the power amplifier (PA) and the maximum downstream SNR

(SNRDS) is about 50 dB. The downstream signal is fed to the ADC, and forms a reference signal to cancel the echo noise floor. The state-of-the-art ADC performance is 65 dBFS or 50 dBrms. With 15 dB PAPR ($SNR_{ADC} = 6.02 * ENOB + 4.77 - PAPR$, $ENOB = 10$), the effective noise floor captured by the ADC is only 3dB ($SNR_{ADC} - SNR_{DS} = 50 - 50 = 0$). Thus the current EC architecture almost cannot cancel echo noise floor. Figure 9 shows that, from 1218MHz to 3138MHz, echo noise floor is about 15dB to 53dB higher than the upstream noise floor. The current EC architecture is incapable of cancelling the very high echo noise floor at higher frequencies.

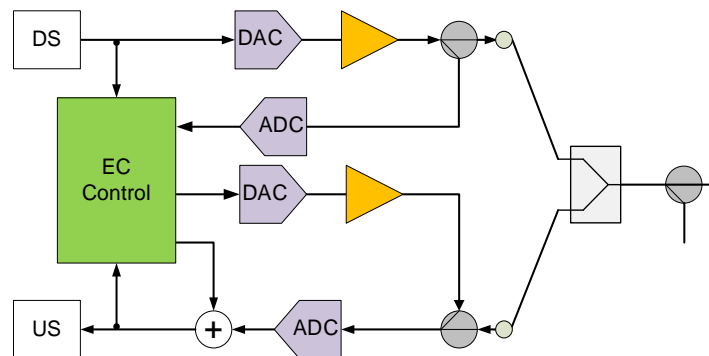

Figure 10 – Current Echo Cancellation Architecture

5. Solution-1 for spectrum extension using Multiple Spectrum Domain

Section 4.1 describes the challenges of extending the spectrum in the N+ 0 HFC cable plant. This section proposes a novel scheme for extending the spectrum to 3 GHz, which overcomes the above challenges in an N+0 plant. The scheme groups the CMs based on their distance from the node, and assigns the high spectrum band to the nearest CMs, middle spectrum band to the midway CMs and the low spectrum band to the farthest CMs. CMs at the same tap share the same spectral band.

5.1. Conception of Multiple Spectrum Domain

In the traditional cable plant, all the CMs have similar received power spectral density and share the same spectrum band. This is achieved by using different attenuation in each tap. The total power transmitted by the node is determined by the worst case CM path loss.

In the extended spectrum the worst case CM path loss is much higher requiring as much as 27 dB of additional transmit power level at the node (see section 4.1.4).

Unlike the traditional scheme, all the CMs in the proposed scheme do not share the same spectral band. By specifying the maximum total path loss cutoff level, the maximum operational frequency of each of the CM can be determined from figure 11. The first row of Table 1 specifies the maximum operational frequency limit of each of the CM for a 55 dB total path loss cutoff level. The CMs can be grouped and assigned appropriate spectral bands, based upon their maximum operational frequency limits, as shown in 2nd and 3rd rows of table-1.

Note the 55 dB total path loss cutoff level is roughly 28 dB below the worst case path loss of 83.3 dB for CM6 at 3.0 GHz.

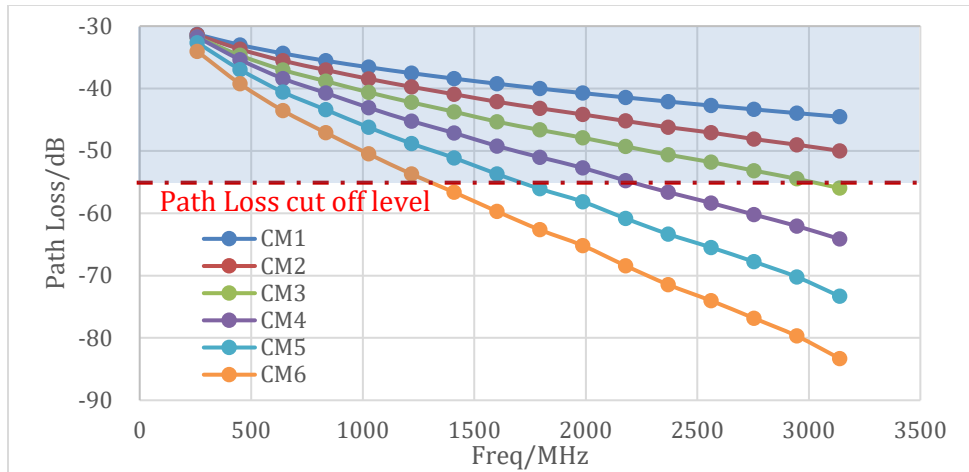

Figure 11 – Total Path Loss from Node to CM on 3GHz Plant

Table 1 – Multiple Spectrum Domain

CM	CM1	CM2	CM3	CM4	CM5	CM6
Max. working Frequency/GHz	3.138	3.138	2.946	2.178	1.794	1.218
Working frequency domain/GHz	2.178~3.138		1.218~2.178		0.108~1.218	
Spectrum group	Group1		Group2		Group3	
Compatibility with current spectrum	Yes		Yes		Yes	

To support current upstream and downstream communications, such as video and full duplex, all the CMs can still continue to use the current spectrum between 5MHz~1.218GHz.

Based on the multiple spectrum domain method, the N+0 HFC plant can be extended from 1.218GHz to 3.138GHz, the extended spectrum can be planed as 10 OFDM channels, the bit loading for each channel can reach about 8~10bit, so that it will add about $9\text{bit}/\text{Hz} \times 192\text{MHz}/\text{ch} \times 100\text{ch} \times 0.87 = 15\text{Gbps}$ for the downstream, consider the 10Gbps for traditional spectrum from 108MHz to 1.218MHz, so the downstream capacity of the system can reach 25Gbps.

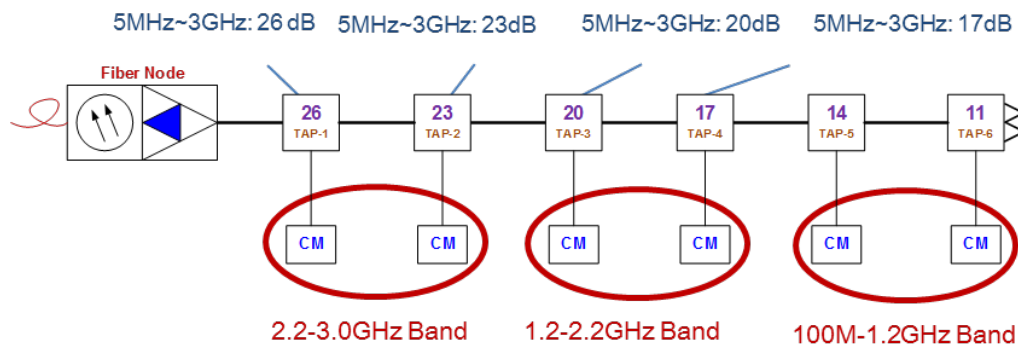

Figure 12 – Multiple Spectrum Domain

Since the group of CMs which are farthest from the node, cannot operate at frequencies beyond 1.2 GHz, it is not necessary to upgrade the last one or two taps to support the extended spectrum of 3.0 GHz frequency.

5.2. FDX CM Transmit Power

The spectrum domain scheme can also be used for FDX. Each CM can transmit the upstream signal and receive the downstream signal at specific spectral bands. All CMs can still continue to use the traditional 108 MHz to 1218 MHz spectrum for FDX operation.

Table 2 shows the TCP of FDX CMs operating at different 1 GHz wide, spectral bands. The assumptions in section 4.2.1 were used to compute the TCP values in Table 2.

Table 2 – FDX CM TCP in 3GHz system

CM	CM1	CM2	CM3	CM4	CM5	CM6
FDX spectrum /GHz	2.178~3.138		1.218~2.178		0.108~1.218	
TCP /dBmV	65	70	68	73	65	69

As seen from Table 2, the TCP of some of the CM exceeds the maximum allowed TCP value of 65 dBmV, by several dBs. This is because the TCP is computed over 1 GHz wide FDX spectrum, instead of the recommended 576 MHz wide (108 MHz to 684 MHz) FDX spectrum.

5.3. Echo Cancellation Requirement at Node

Using the assumptions and method of section 4.2.2, the echo level at node for the 3GHz FDX system can be calculated as shown in Figure 13.

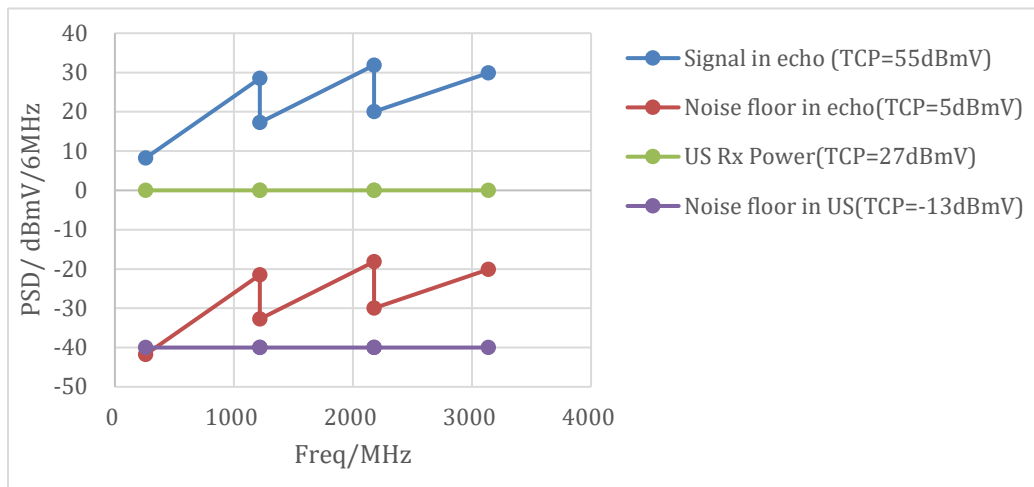

Figure 13 – Echo Level at Node for 3 GHz FDX system

To get a minimum SNR of 35dB for the upstream, the echo cancellation ability should reach $54.6 - (-13 + 5) = 62\text{dB}$. In current FDX DOCSIS system operating at 108~684MHz, the EC requirement is about 55~60dB. Thus the EC requirement for 3GHz FDX system is similar to current 108~684MHz FDX system.

5.4. New Echo Cancellation Architecture

As mentioned in section 4.2.3, current EC architecture shown in Figure 10 has limited ability to cancel the echo noise floor, limiting the maximum achievable SNR for the upstream signal. To improve noise floor cancellation capability, a new EC architecture is introduced with improved range of captured noise floor. Figure 14 shows the proposed EC architecture using two ADCs and three DACs. Before

captured by the ADC2, the signal part in reference echo is cancelled by DAC3, and only the noise floor is left. Thus the level of noise floor can reach to the level before PA (about 20–30dB). In Figure 13, the echo noise floor is less than 20dB higher than noise floor of the upstream signal, so this new EC architecture can cancel the entire echo noise floor.

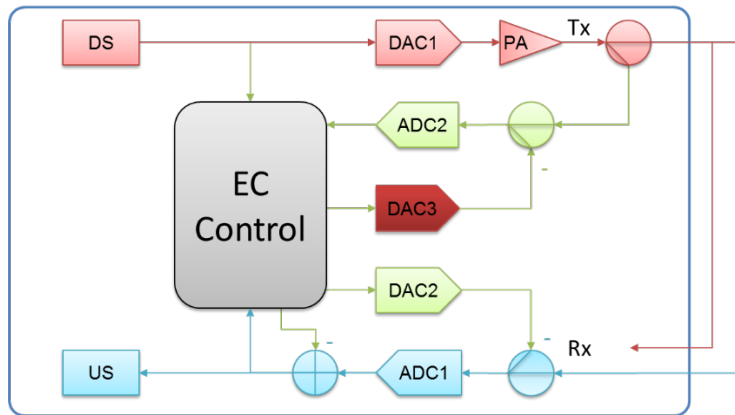

Figure 14 – New EC Architecture

5.5. New Tap Design to Increase Isolation

In the FDX system, due to low inter-branch isolation of the tap, the CMs connected to the same tap are grouped under same transmission group (TG). In the transmission group, all the CMs work in the frequency-division mode, and cannot use the same frequency for upstream and downstream at the same time. To improve the utilization of bandwidth, more transmission groups are desired in the N+0 plant, especial for the 3GHz FDX system. A single tap can be replaced by a cascade of two taps to increase the isolation between CMs, as shown in Figure 15. In the case, there can be two transmission groups in one tap, increasing the flexibility of bandwidth allocation to each CM.

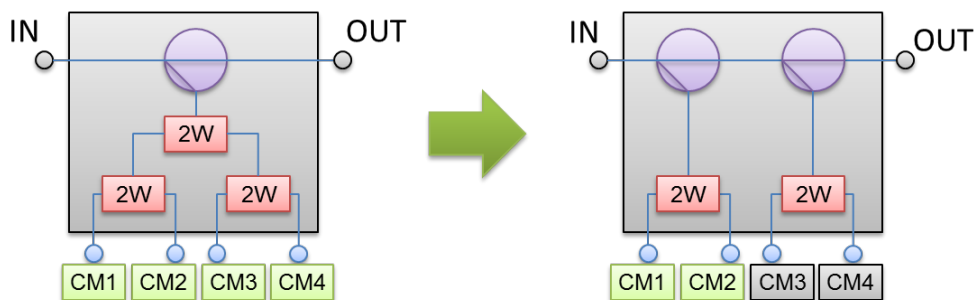

Figure 15 – New Tap Design to Increase Isolation

6. Solution2: Novel Plant with Duplex Tap

Using the multiple spectrum domain method, the N+0 HFC plant can operate at 3GHz, both in regular and FDX modes. But some parameters still slightly exceed the acceptable limits, such as the downstream TCP of the node, and the upstream TCP of the FDX CM. This section presents a novel design and architecture which further reduces this gap.

6.1. Special Duplexer Tap

In a traditional 3 GHz tap, the branch loss is approximately same for the entire frequency range from 5 MHz to 3 GHz. A 26 dB tap, has a 26 dB branch loss for all frequencies between 5 MHz to 3 GHz. In the spectrum grouping method, the high branch loss of the tap, at high spectral band 2–3 GHz results in loss of signal power and is undesirable.

To overcome this loss of signal power in the high spectral band, the trunk tap can be replaced with a novel duplexer tap. The duplexer tap can either directly pass the high spectral band signal to the tap branches without any tap loss, or pass the high spectral band through a tap with lower loss.

In order to support current upstream communications, video and full duplex communications channels, the tap branches the low band signal between 5 MHz to 1.218 GHz with a normal 26dB loss.

The first tap (tap426) pass both the high and low frequency bands to the branch as well as to the output. The output of tap426 is connected to the next tap, tap423.

Tap423 passes the high spectral band to the branch without any loss.

Figure 166 shows the block diagram of duplexer tap426 and its characteristics. It can be seen that this duplex tap will reduce the path loss by 15dB, for the high spectral band compared to the low spectral band.

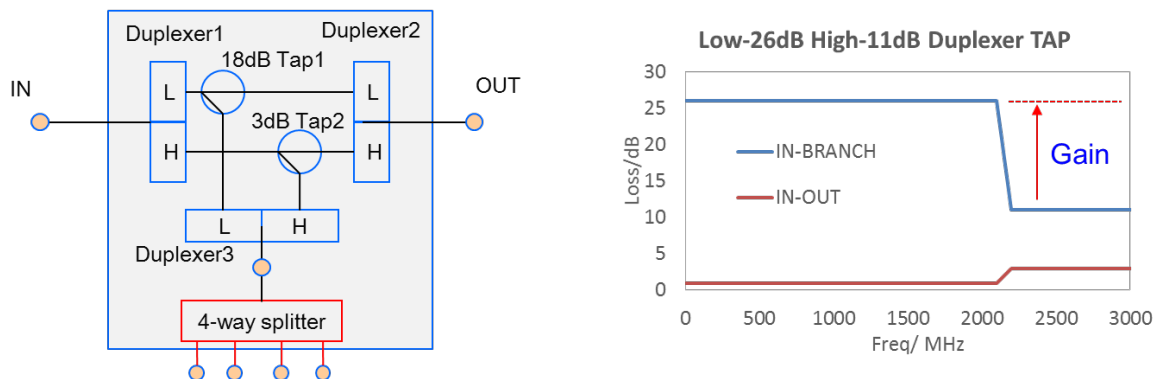

Figure 16 – Duplexer Tap 426 (type 1)

Figure 17 is a block diagram of duplexer tap 423 and its characteristics.

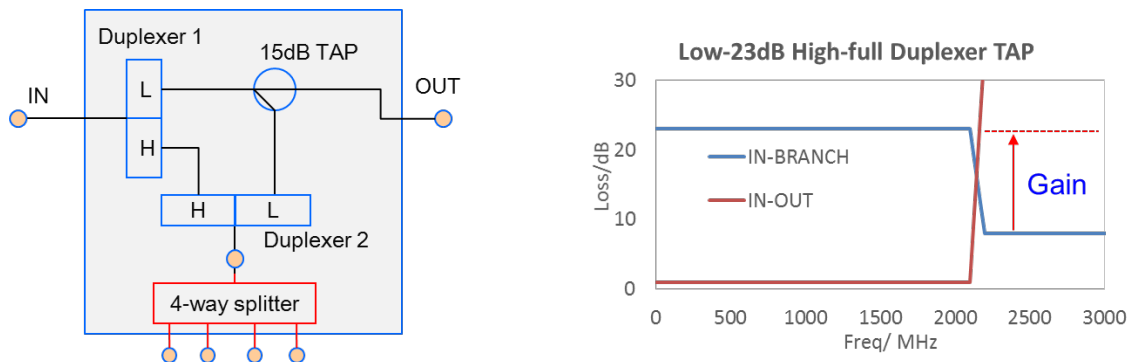

Figure 17 –Duplexer Tap 423 (type 2)

The proposed novel duplexer has following features: 1) Different tap loss at different frequency segments. 2) All the individual components are pluggable and replaceable. 3) Ability to reduce the path loss at high frequency. 4) Combines the advantages of magnetic core and micro-strip. Magnetic core has good performance at low frequency, while micro-strip have good performance at high frequency. 4) Ability to support high frequencies of 3GHz and 6 GHz.

6.2. N+0 HFC Plant with Duplex Tap

Figure 188 shows an N+0 HFC plant using duplexer taps. To achieve desired bandwidth allocation with desired tap loss, the traditional trunk taps are replaced with appropriate duplexer taps. CM1 and CM2 operate at the high spectral band between 2.178~3.138GHz, CM3 and CM4 operate at the mid spectral band between 1.218~2.178GHz, and CM5 and CM6 operate at the regular low spectral band between 5 MHz to 1.2GHz. Tap20 and tap 17 are duplexer taps with same pass band but with different tap loss. Tap 26 and 23 are duplexer taps with same pass band but different tap loss. Tap14 and tap11 can be traditional 1.2GHz or 3.0GHz taps.

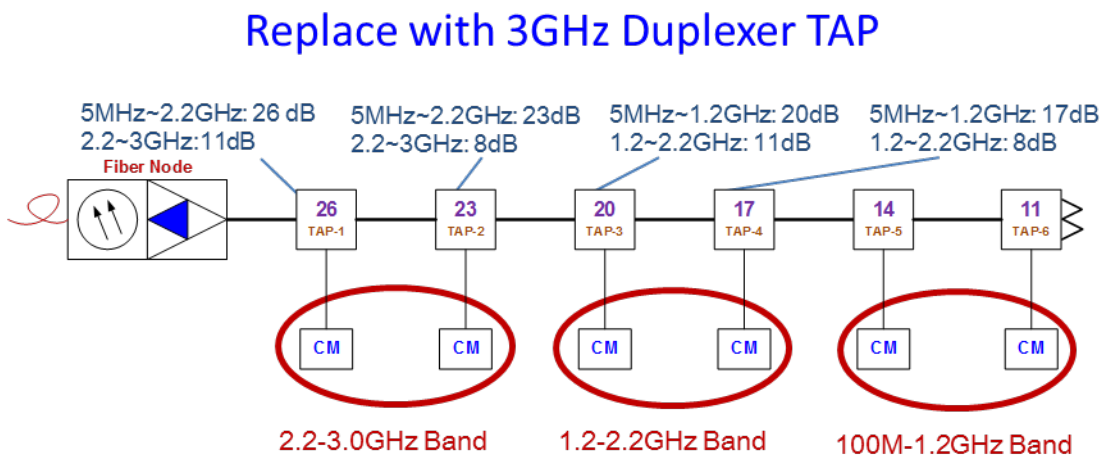

Figure 18 –N+0 HFC plant with duplexer taps

The chain of duplexer taps, channels the signal of each spectral band to its allocated group of CMs, with the desired power levels. This scheme makes optimum use of the entire frequency band supported by the cable plant. The simple equivalent architecture scheme is shown in Figure 19. It should be noted that all the CMs can still continue to support the current low spectrum band of 5MHz~1.218GHz.

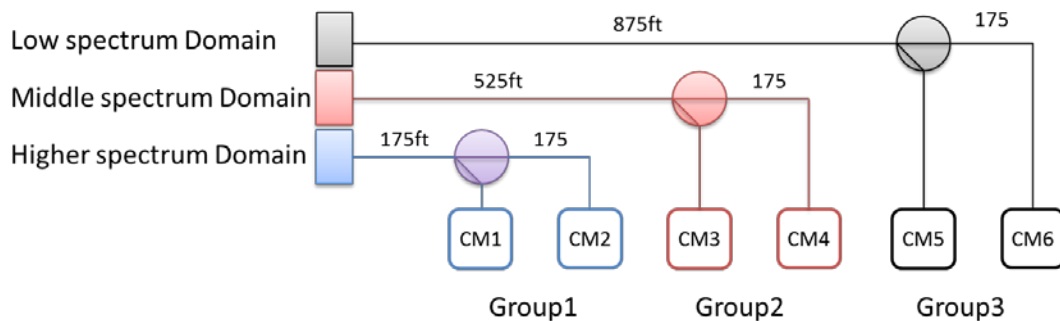

Figure 19 – Equivalent Diagram of the New N+0 HFC Plant

Figure 20 shows the path loss from node to CMs, using the parameters of Figure 188. As shown in Figure 20, the path loss of CM1 at the higher spectral band of 2.178 to 3.128 GHz is less than 30 dB. Therefore, using this scheme, it is very much possible to extend the spectrum to 3 GHz or even 6 GHz.

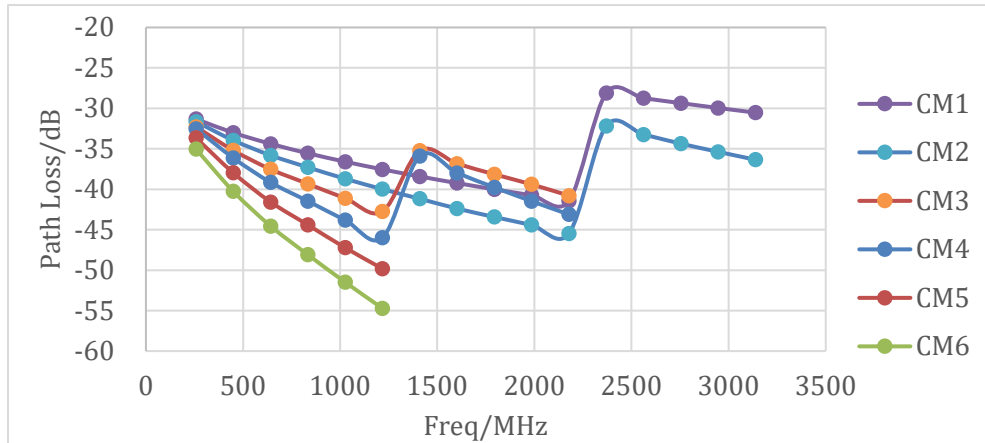

Figure 20 – Path Loss from Node to CM

6.3. Node Transmit Power for plant using duplexer taps

Figure 21 shows the transmit power level of the node for the duplexer tap scheme of Figure 18. The transmit power level is computed using the path loss of Figure 20 and assuming a CM received power level of 0 dBmV/6 MHz for all CMs. To support 1.218~2.178GHz, only 64.6dBmV is needed. To support 2.178~3.138GHz, only 58.3dBmV is needed. The TCP of whole DS spectrum 0.18~3.138GHz is 74.2dBmV, which is within the acceptable maximum transmit power of 73~75dBmV required for traditional 1 GHz wide spectrum.

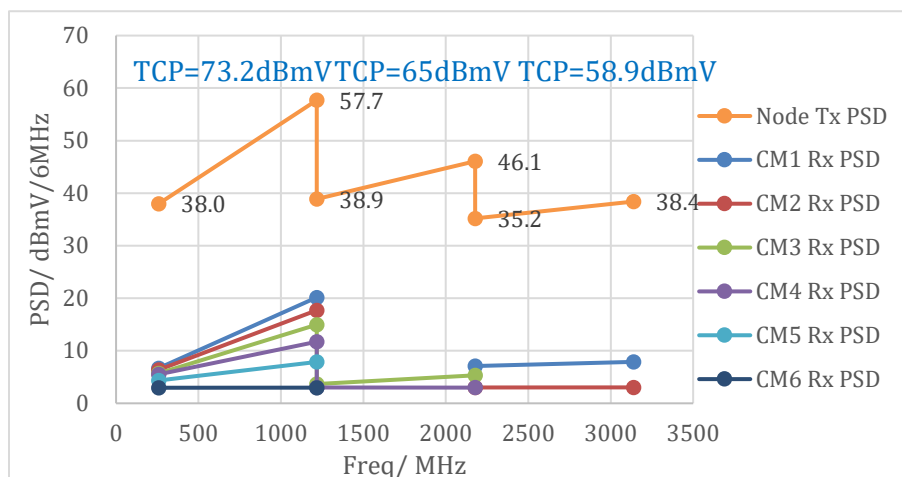

Figure 21 – Node Transmit Power

6.4. FDX CM Transmit Power with duplexer taps

Table 3 gives the TCP of FDX CMs for the cable plant of Figure 18 using duplexer taps. The TCP values are computed using the assumptions and method of section 4.2.1. As seen from Table 3, the TCPs of the first four CMs (CM1 to CM4) are well within the 65 dBmV limit. The TCP of CM5 and CM6 exceeds the 65 dBmV limit by 1 and 5 dBs respectively.

Table 3 – FDX CM TCP in 3GHz system with duplexer tap

CM	CM1	CM2	CM3	CM4	CM5	CM6
FDX spectrum /GHz	2.178~3.138		1.218~2.178		0.108~1.218	
TCP /dBmV	51	56	60	62	66	70

6.5. Echo Cancellation Requirement at Node

Figure 22 shows the echo levels at the node for 3GHz FDX scheme using duplexer taps in the plant. The echo levels are computed using the assumptions and method of section 4.2.2. As seen from the figure, the EC requirement for the higher spectral band of 2.178 to 3.138GHz is lower than the traditional FDX band of 108~684MHz. Thus using duplexer taps in the plant allows the operation of FDX in higher frequency bands extending up to 3 GHz and beyond.

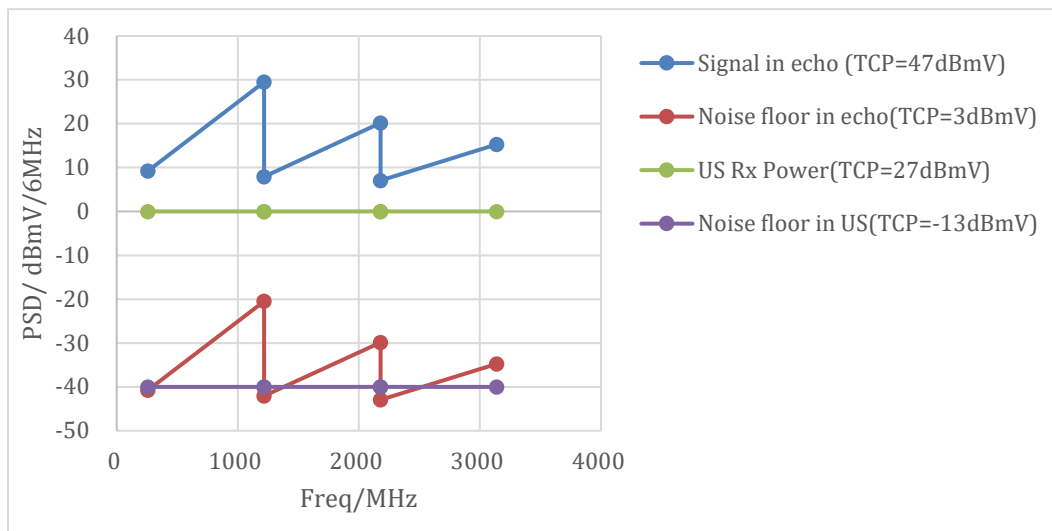

Figure 22 – Echo Cancellation Requirement at Node

7. Comparison of Spectral Extension methods

The traditional spectrum extension method is not practical because of the following reasons; 1) the total required power of the node is around 25 dB higher than the maximum limit of 75 dBmV. 2) Extending the spectrum for the FDX results in high transmit power requirements at the CM side and high echo cancellation requirements at the node side.

The proposed spectrum extension method using multiple spectrum domain groups the CMs based on their distance from the node, and assign lower frequency band to CMs which are farthest from the node and higher frequency band to CMs which are closest to the node. With this method, the node transmit power needs to be increased by additional 3~5dB (beyond the maximum limit of 75 dBmV) to

achieve a total downstream capacity of 25Gbps. For symmetric 25Gbps FDX operation, some modifications are required both at the node side and the CM side.

The proposed duplexer taps in the plant results in a steep reduction of the path loss for higher spectral band. It enables the operation of 3 GHz FDX operation to achieve 25 Gbps capacity, without any additional requirements. This scheme makes optimum use of the entire frequency band supported by the cable plant. It is also possible to expand the spectrum to 6 MHz using this scheme.

8. HFC and DOCSIS Migration Steps

Even though the FDX DOCSIS started more than a year ago, and the specification is about to be finished soon, its deployment by the MSO is nowhere near in sight. The FDX requires an N+0 HFC plant. But it will be several years from now before the MSOs could migrate to N+0 state from the current N+5/3 in substantial numbers. The authors of this paper believe there will be other transitional migration steps between DCOSIS 3.1 and future FDX, such as the 1.8GHz spectrum extension, DOCSIS for the N+5/3/1 network, the upstream spectrum expansion, it can be called as 'D3.1+', and showed in Figure 23. Once MSO begins to deploy Node+0 Fiber Deep architecture designs, FDX combined with extended spectrum DOCSIS systems can be used to achieve symmetric 25Gbps upstream/downstream capacity.

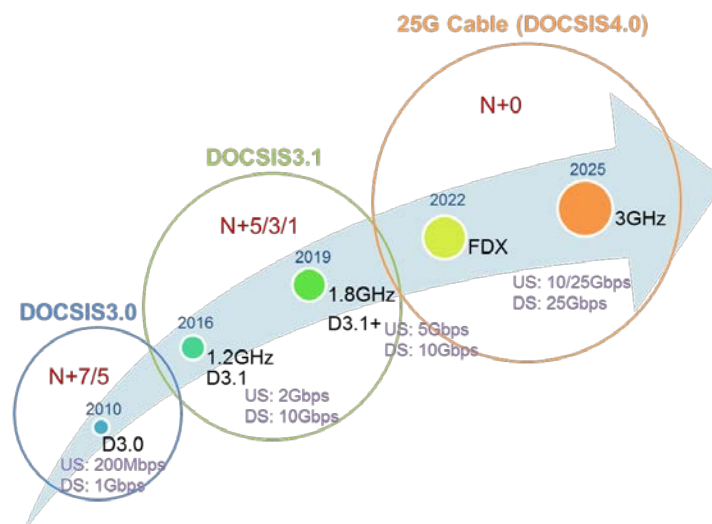

Figure 23 – HFC and DOCSIS possible migration steps

9. Conclusions

In anticipation of future bandwidth growth requirements for the cable access network, operating FDX DOCSIS in expanded spectrum to achieve a rate of 10Gbps for upstream and 25Gbps for downstream can be a novel idea to greatly increase the spectral efficiency. Through its novel design schemes, this paper expands the DOCSIS spectrum to 3GHz and also enables use of FDX DOCSIS in higher spectrum. First we described the challenges and problems in operating DOCSIS and FDX in extended spectrum. Second, a novel design 'Multiple Spectrum Domain' is introduced to operate DOCSIS and FDX in extended spectrum: Grouping the CM based on their distance from the node, and assigning high spectral band to the nearest CMs, middle spectral band to the midway CMs and low spectral band to the farthest CMs. A new echo cancellation architecture is proposed to cancel the echo noise floor. Third, a special designed duplexer tap is introduced to split the signal into different spectrum bands with different loss. It solves the excessive power attenuation issue when operating

DOCSIS and FDX in higher spectrum. It does not place any additional requirements to operate FDX at 3GHz and achieve a rate of 10Gbps for upstream and 25Gbps for downstream. Finally, we presented the HFC and DOCSIS possible migration steps for the next ten years. Once MSOs begin to deploy Node+0 fiber deep architecture, FDX can be combined with extended spectrum DOCSIS to achieve a rate of 10Gbps for upstream and 25Gbps for downstream.

10. Abbreviations and Definitions

10.1. Abbreviations

ADC	Analog to digital convertor
CM	Cable modem
DAC	Digital to analog convertor
DOCSIS	DOCSIS Data-Over-Cable Service Interface Specifications
DS	downstream
HFC	hybrid fiber-coax
US	upstream

11. Bibliography and References

Tao Ouyang. *Next Generation Technology beyond DOCSIS3.1*, SCTE Cable-tec Expo 2016, SEP 26, 2016

