

Errata Notice on Schema Locations

March 17, 2022

This standard makes use of namespace locations with a form of <http://www.scte.org/schemas/xyz/>*, where “xyz” is the location of the specific schema being referenced. Due to limitations on the current SCTE website, those specific locations are not available.

To find such schemas:

1. Go to the standards download page at <https://www.scte.org/standards/library/catalog/>
2. Search for the standard number (xyz in the above example)
3. Select the document from the table
4. Scroll to the “Supporting Documentation” section of the document webpage.

The schema will be listed within the Supporting Documentation section.

This notice will be removed once the exact namespace values are functional.

SCTE • ISBE[®]

S T A N D A R D S

Digital Video Subcommittee

AMERICAN NATIONAL STANDARD

ANSI/SCTE 130-4 2020

**Digital Program Insertion–Advertising Systems
Interfaces Part 4
Content Information Service (CIS)**

NOTICE

The Society of Cable Telecommunications Engineers (SCTE) / International Society of Broadband Experts (ISBE) Standards and Operational Practices (hereafter called “documents”) are intended to serve the public interest by providing specifications, test methods and procedures that promote uniformity of product, interchangeability, best practices and ultimately the long-term reliability of broadband communications facilities. These documents shall not in any way preclude any member or non-member of SCTE•ISBE from manufacturing or selling products not conforming to such documents, nor shall the existence of such standards preclude their voluntary use by those other than SCTE•ISBE members.

SCTE•ISBE assumes no obligations or liability whatsoever to any party who may adopt the documents. Such adopting party assumes all risks associated with adoption of these documents, and accepts full responsibility for any damage and/or claims arising from the adoption of such documents.

Attention is called to the possibility that implementation of this document may require the use of subject matter covered by patent rights. By publication of this document, no position is taken with respect to the existence or validity of any patent rights in connection therewith. SCTE•ISBE shall not be responsible for identifying patents for which a license may be required or for conducting inquiries into the legal validity or scope of those patents that are brought to its attention.

Patent holders who believe that they hold patents which are essential to the implementation of this document have been requested to provide information about those patents and any related licensing terms and conditions. Any such declarations made before or after publication of this document are available on the SCTE•ISBE web site at <http://www.scte.org>.

All Rights Reserved

© Society of Cable Telecommunications Engineers, Inc. 2020
140 Philips Road
Exton, PA 19341

Table of Contents

Title	Page Number
NOTICE.....	2
Table of Contents.....	3
1. Scope.....	7
2. Normative References.....	7
2.1. SCTE References.....	7
2.2. Standards from Other Organizations.....	7
2.3. Published Materials.....	7
3. Informative References.....	8
3.1. SCTE References.....	8
3.2. Standards from Other Organizations.....	8
3.3. Published Materials.....	8
4. Compliance Notation.....	8
5. Abbreviations and Definitions.....	9
5.1. Abbreviations.....	9
5.2. Definitions.....	9
6. Content Information Service Overview (INFORMATIVE).....	9
7. Notational Conventions.....	10
7.1. Normative XML Schema.....	10
7.2. Document Conventions.....	11
8. Processing Conventions.....	11
8.1. Unknown/Unrecognized/Unsupported XML Elements and Attributes.....	11
9. XML Namespaces.....	11
10. Data Model And Query Support.....	13
11. CIS Messages.....	13
11.1. @version Attribute.....	14
11.2. Request Base Message.....	14
11.2.1. Request Base Message Attributes.....	14
11.2.2. Request Base Message Elements.....	14
11.3. Response Base Message.....	14
11.3.1. Base Response Message Attributes.....	14
11.3.2. Base Response Message Elements.....	15
11.4. Notification Base Message.....	15
11.4.1. Notification Base Message Attributes.....	15
11.4.2. Notification Base Message Elements.....	15
11.5. Acknowledgement Base Message.....	15
11.5.1. Acknowledgement Base Message Attributes.....	15
11.5.2. Acknowledgement Base Message Elements.....	15
11.6. Messages Requiring Notification Registration.....	15
11.7. CIS Message Exchange.....	15
11.8. CISListSupportedFeaturesRequest and Response.....	16
11.8.1. CISListSupportedFeaturesRequest Message.....	16
11.8.2. CISListSupportedFeaturesResponse Message.....	17
11.9. CISListQualifiersRequest and Response Messages.....	19
11.9.1. CISListQualifiersRequest Message.....	19
11.9.2. CISListQualifiersResponse Message.....	20
11.10. CISListNotificationRegistrationRequest and Response.....	22
11.10.1. CISListNotificationRegistrationRequest Message.....	22
11.10.2. CISListNotificationRegistrationResponse Message.....	23
11.11. CISNotificationRegistrationRequest and Response.....	25
11.11.1. CISNotificationRegistrationRequest Message.....	25
11.11.2. CISNotificationRegistrationResponse Message.....	27

11.12.	CISNotification and Acknowledgement.....	28
11.12.1.	CISNotification Message.....	28
11.12.2.	CISNotificationAcknowledgement Message.....	30
11.13.	CISCreateCursorRequest and Response.....	31
11.13.1.	CISCreateCursorRequest Message.....	31
11.13.2.	CISCreateCursorResponse Message.....	32
11.14.	CISCancelCursorRequest and Response.....	34
11.14.1.	CISCancelCursorRequest Message.....	34
11.14.2.	CISCancelCursorResponse Message.....	35
11.15.	CISQueryRequest and Response.....	36
11.15.1.	CISQueryRequest Message.....	36
11.15.2.	CISQueryResponse Message.....	37
11.16.	CISNotificationDeregisterRequest and Response.....	39
11.16.1.	CISNotificationDeregisterRequest Message.....	39
11.16.2.	CISNotificationDeregisterResponse Message.....	40
11.17.	CISDeregistrationNotification and Acknowledgement.....	41
11.17.1.	CISDeregistrationNotification Message.....	42
11.17.2.	CISDeregistrationAcknowledgement Message.....	43
11.18.	Service Check Support.....	44
11.19.	Service Status Support.....	44
11.20.	CIS Attribute Types.....	44
11.21.	CIS Elements.....	44
Appendix A	CableLabs VOD Metadata 1.1 Data Model Connector (Normative).....	45
A.1	Normative References.....	45
A.2	ServiceDataModel URL.....	45
A.3	Unique Qualifiers.....	45
A.4	Query and Response.....	46
A.5	Query Semantics.....	46
Appendix B	SCTE 236 Metadata Data Model Connector (Normative).....	48
B.1	XML Namespaces.....	48
B.2	Normative References.....	48
B.3	ServiceDataModel URL.....	48
B.4	Unique Qualifiers.....	48
B.5	Query and Response.....	49
B.6	Query Semantics.....	49
Appendix C	Content Forecasting Data Model Connector (Normative).....	51
C.1	ServiceDataModel URL.....	51
C.2	Unique Qualifiers.....	51
C.3	Qualifiers.....	51
C.4	Query and Response.....	52
C.5	Query Semantics.....	52
C.6	ContentBasicQueryResult XML Schema.....	52
C.7	ContentBasicQueryResult Element Details.....	53
C.7.1	ContentBundle.....	53
C.7.2	DataModelContent.....	54
C.7.3	Region.....	54
C.7.4	Owner.....	55
Appendix D	WSDL (Normative).....	55
Appendix E	Generic Data Model Connector (Informative).....	56
Appendix F	List Qualifiers Request and Response Example (Informative).....	57
Appendix G	Query Request and Response (Informative).....	58

List of Figures

Title	Page Number
Figure 1 - CIS Content Storage	9
Figure 2 - CIS Forecasting	10
Figure 3 - CIS Message Exchange	16
Figure 4 - CISListSupportedFeaturesRequest XML Schema	17
Figure 5 - CISListSupportedFeaturesResponse XML Schema	18
Figure 6 - CISListQualifiersRequest XML Schema	20
Figure 7 - CISListQualifiersResponse XML Schema	21
Figure 8 - CISListNotificationRegistrationRequest XML Schema	23
Figure 9 - CISListNotificationRegistrationResponse XML Schema	24
Figure 10 - CISNotificationRegistrationRequest XML Schema	26
Figure 11 - CISNotificationRegistrationResponse XML Schema	28
Figure 12 - CISNotification XML Schema	29
Figure 13 - CISNotificationAcknowledgement XML Schema	30
Figure 14 - CreateCursorRequest XML Schema	32
Figure 15 - CreateCursorResponse XML Schema	33
Figure 16 - CISCancelCursorRequest XML Schema	34
Figure 17 - CISCancelCursorResponse XML Schema	35
Figure 18 - CISQueryRequest XML Schema	37
Figure 19 - CISQueryResponse XML Schema	38
Figure 20 - CISNotificationDeregisterRequest XML Schema	40
Figure 21 - CISNotificationDeregisterResponse XML Schema	41
Figure 22 - CISDeregistrationNotification XML Schema	42
Figure 23 - CISDeregistrationAcknowledgement XML Schema	43
Figure 24 - VOD Metadata 1.1 Data Model Connector XML Schema	47
Figure 25 – SCTE 236 Metadata Data Model Connector XML Schema	50
Figure 26 - Content Forecasting Data Model Connector XML Schema	52
Figure 27 - ContentBundle XML Schema	53
Figure 28 - DataModelContent XML Schema	54
Figure 29 - Region XML Schema	55
Figure 30 - Owner XML Schema	55

List of Tables

Title	Page Number
Table 1 - XML Namespace Declarations	11
Table 2 - CIS Top Level Messages	13
Table 3 - ListSupportedFeatures core:Callout @message values	19
Table 4 - CISNotificationRegistrationResponse core:Callout @message values	27
Table 5 - VOD Metadata 1.1 Data Model Connector Normative References	45
Table 6 - gis:ServiceDataModel Definition for VOD Metadata 1.1 Data Model Connector	45
Table 7 - @expandOutput Options for the VOD Metadata 1.1 Data Model Connector	46

Table 8 – SCTE 236 Metadata Data Model Connector Namespaces 48
 Table 9 – SCTE 236 Metadata Data Model Connector Normative References 48
 Table 10 - gisServiceDataModel Definition for SCTE 236 Data Model Connector..... 48
 Table 11 - @expandOutput choices for SCTE 236 Data Model Connector 49
 Table 12 - gis:ServiceDataModel Definition for Content Forecasting Data Model Connector..... 51
 Table 13 - Content Forecasting Data Model Connector Qualifier Descriptions..... 51

List of Examples

Title	Page Number
Example 1: VOD Metadata 1.1 Data Model Unique Qualifiers	46
Example 2: SCTE 236 Metadata Data Model Unique Qualifier	49
Example 3: Content Forecasting Qualifier Declarations	52
Example 4: CISListQualifiersRequest.....	57
Example 5: CISListQualifiersResponse	58
Example 6: CISQueryRequest.....	58
Example 7: CISQueryResponse	59
Example 8: CISQueryRequest for expanded output.....	59
Example 9: CISQueryResponse	61
Example 10: Content Forecasting Data Model CISQueryRequest.....	61
Example 11: Content Forecasting Data Model CISQueryResponse	62

1. Scope

This document, SCTE 130 Part 4, describes the Digital Program Insertion Advertising Systems Interfaces' Content Information Service (CIS) messaging and data type specification using XML, XML Namespaces, and XML Schema.

2. Normative References

The following documents contain provisions, which, through reference in this text, constitute provisions of this document. At the time of Subcommittee approval, the editions indicated were valid. All documents are subject to revision; and while parties to any agreement based on this document are encouraged to investigate the possibility of applying the most recent editions of the documents listed below, they are reminded that newer editions of those documents might not be compatible with the referenced version.

2.1. SCTE References

[SCTE130-1]	SCTE 130-1 2020: Digital Program Insertion—Advertising Systems Interfaces Part 1—Overview
[SCTE130-2]	SCTE 130-2 2020: Digital Program Insertion—Advertising Systems Interfaces Part 2 - Core Data Elements
[SCTE130-7]	ANSI/SCTE 130-7 2020: Digital Program Insertion – Advertising Systems Interface Part 7 – Message Transport
[SCTE130-8]	SCTE 130-8 2020: Digital Program Insertion – Advertising Systems Interfaces Part 8 – General Information Service
[W3C - XSD]	XML Schema Part 1: Structures Second Edition

2.2. Standards from Other Organizations

- No normative references are applicable.

2.3. Published Materials

- No normative references are applicable.

2.1.1 Normative Reference Acquisition

2.1.1.1 SCTE Standards: United States of America

Society of Cable Telecommunications Engineers Inc., 140 Philips Road, Exton, PA 19341; Telephone 800-542-5040; Facsimile: 610-363-5898; E-mail: standards@scte.org; URL: <http://www.scte.org>.

2.1.1.2 W3C Standards

MIT, 32 Vassar Street, Room 32-G515, Cambridge, MA 02139, USA; Telephone: +1.617.258.5999;
<http://www.w3.org..>

3. Informative References

The following documents might provide valuable information to the reader but are not required when complying with this document.

3.1. SCTE References

- No informative references are applicable.

3.2. Standards from Other Organizations

- No informative references are applicable.

3.3. Published Materials

- No informative references are applicable.

4. Compliance Notation

<i>shall</i>	This word or the adjective “ <i>required</i> ” means that the item is an absolute requirement of this document.
<i>shall not</i>	This phrase means that the item is an absolute prohibition of this document.
<i>forbidden</i>	This word means the value specified shall never be used.
<i>should</i>	This word or the adjective “ <i>recommended</i> ” means that there may exist valid reasons in particular circumstances to ignore this item, but the full implications should be understood and the case carefully weighted before choosing a different course.
<i>should not</i>	This phrase means that there may exist valid reasons in particular circumstances when the listed behavior is acceptable or even useful, but the full implications should be understood and the case carefully weighed before implementing any behavior described with this label.
<i>may</i>	This word or the adjective “ <i>optional</i> ” means that this item is truly optional. One vendor may choose to include the item because a particular marketplace requires it or because it enhances the product, for example; another vendor may omit the same item.
<i>deprecated</i>	Use is permissible for legacy purposes only. Deprecated features may be removed from future versions of this document. Implementations should avoid use of deprecated features.

5. Abbreviations and Definitions

5.1. Abbreviations

All [SCTE130-2], [SCTE130-7] and [SCTE130-8] definitions are included herein. See [SCTE 130-2], [SCTE130-7] and [SCTE130-8] for additional information. This interface is an advertising service of [SCTE130-8] and makes references accordingly.

CIS	content information service
-----	-----------------------------

5.2. Definitions

All [SCTE130-2], [SCTE130-7] and [SCTE130-8] definitions are included herein. See [SCTE130-2], [SCTE130-7] and [SCTE130-8] for additional information.

6. Content Information Service Overview (INFORMATIVE)

A CIS provides asset metadata query and notification services, including media availability if known, to service consumers. Using the interfaces defined in this specification, service consumers may retrieve detailed information about assets referenced by a CIS.

There are multiple use cases supported by this standard. A straightforward example is a VOD or linear delivery system with stored ad content. The advertising system queries the delivery system's available storage using the CIS interface to insure ad copy is available for placement.

A second CIS use is to inform an advertising system of available entertainment content or metadata for creating and directing campaigns. In this case, an advertising system may adjust dynamically to the arrival of new entertainment content, or metadata.

Figure 1 shows the location and possible clients of a CIS representing stored ad or entertainment content.

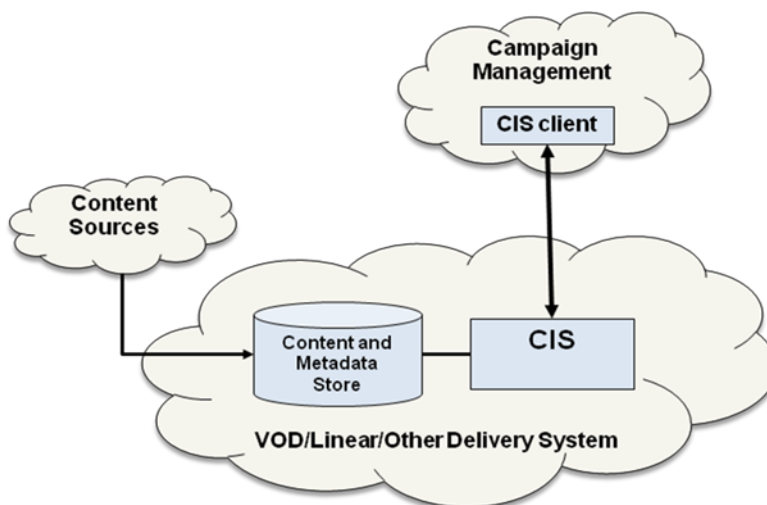

Figure 1 - CIS Content Storage

A third use case, referred to as 'forecasting' herein, has the advertising system or campaign manager include a CIS in order to provide information relative to ad and/or entertainment assets required by clients

at the present time, or at some future time. Content information returned by a forecasting service does not necessarily reflect stored ad copy, but rather reflects current or upcoming ad and/or entertainment copy needs. The client of such a forecasting service could use the retrieved information to obtain, transcode and/or otherwise prepare ad and/or entertainment assets for current or future needs.

Note that all the use cases outlined above may exist in the same system. A delivery system may access a forecasting service to access and prepare ad copy. When the ad copy is available for placement, the delivery system may update or notify the advertising system the available ad copy has changed, and the advertising system may then begin to include the new advertisements in advertising decisions.

Figure 2 below illustrates this use of dual CIS services.

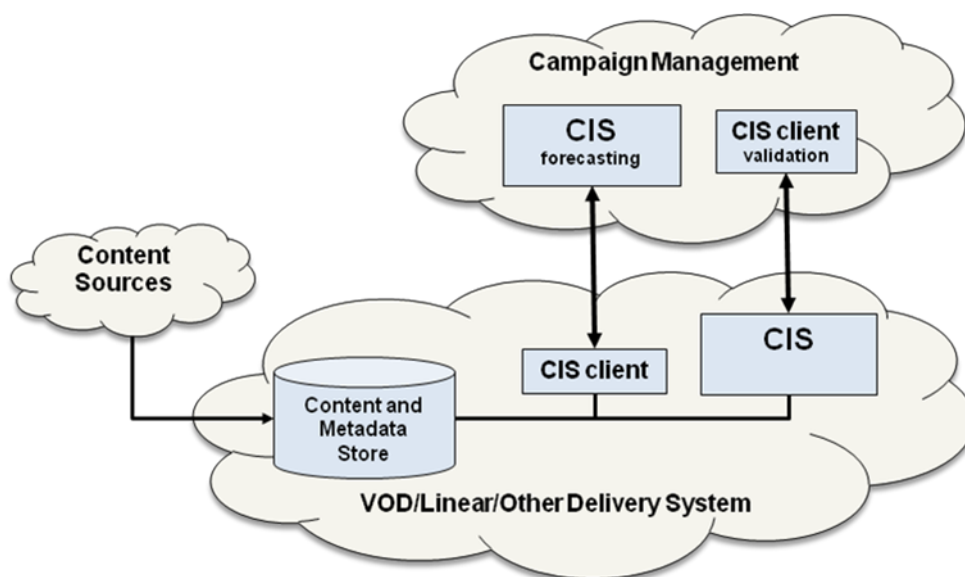

Figure 2 - CIS Forecasting

Part 4, this document, facilitates the expression of CIS supported data models through the use of XML substitution groups. The inclusion of multiple data models is accomplished using a 'connector schema'. Connector schemas conform to SCTE 130 Part 8 by extending the definition of the `gis:BasicQueryResultAbstract`, using XML substitution groups. These substitution groups may include references to additional namespaces and/or XML elements.

See Appendix E for an explanation of the generic format of a connector schema. Also see Appendices A, B and C for optional normative connectors defined by this standard.

7. Notational Conventions

7.1. Normative XML Schema

SCTE 130 Part 4 employs the same notational conventions as [SCTE130-8]. Refer to [SCTE130-8] for an explanation of notational conventions.

7.2. Document Conventions

SCTE 130 Part 4 employs the same document conventions as [SCTE130-8]. Refer to [SCTE130-8] for an explanation of document conventions.

8. Processing Conventions

8.1. Unknown/Unrecognized/Unsupported XML Elements and Attributes

See [SCTE130-2] for information.

9. XML Namespaces

This specification uses the ‘cis’ prefix, as described in Table 1, for the interface associated with the specific XML namespace URI that shall be used by all implementations. Table 1 lists the prefix, the corresponding namespace, and a description of the defining specification used herein.

Table 1 - XML Namespace Declarations

Standard	XML Schema Prefix	XML Schema Elements	Value
2020 (latest)	core (SCTE 130-2)	Schema namespace	http://www.scte.org/schemas/130-2/2008a/core ¹
		Schema version attribute	20200321
		Schema filename	SCTE_130-2_core_20200321.xsd
	cis (This doc.)	Schema namespace	http://www.scte.org/schemas/130-4/2011/cis ²
		Schema version attribute	20200603

¹ While this specification has a ratified year of 2020, the XML schema/XSD namespace has a year of 2008a, which is the year the XSD and this specification’s syntax was initially ratified. All subsequent changes have been backwards compatible and thus, the namespace has not changed.

² While this specification has a ratified year of 2020, the XML schema/XSD namespace has a year of 2011, which is the year the XSD and this specification’s syntax was initially ratified. All subsequent changes have been backwards compatible and thus, the namespace has not changed.

		Schema filename	SCTE_130-4_cis_20200603.xsd
	query (This doc.)	Schema namespace	http://www.scte.org/schemas/130-4/2011/cis/query ³
		Schema version attribute	CL1.1 = 20200603 SCTE 236 = 20200603 CFS = 20200603
		Schema filename	CL1.1 = SCTE_130-4_query_cl1-1_20200603.xsd SCTE 236 = SCTE_130-4_query_scte236_20200603.xsd CFS = SCTE_130_4_query_cfs_20200603.xsd
	gis (SCTE 130-8)	Schema namespace	http://www.scte.org/schemas/130-8/2011/gis ⁴
		Schema version attribute	20200325
		Schema filename	SCTE_130-8_gis_20200325.xsd
	wsdl (This doc. Appendix B)	Schema namespace	http://www.scte.org/wSDL/130-4/2011/cis ⁵
		Schema version attribute	n/a
		WSDL filename	SCTE_130-4_cis_20200603.wsdl

³ While this specification has a ratified year of 2020, the XML schema/XSD namespace has a year of 2011, which is the year the XSD and this specification's syntax was initially ratified. All subsequent changes have been backwards compatible and thus, the namespace has not changed.

⁴ While this specification has a ratified year of 2020, the XML schema/XSD namespace has a year of 2011, which is the year the XSD and this specification's syntax was initially ratified. All subsequent changes have been backwards compatible and thus, the namespace has not changed.

⁵ While this specification has a ratified year of 2020, the WSDL namespace has a year of 2011, which is the year the WSDL and this specification's syntax was initially ratified. All subsequent changes have been backwards compatible and thus, the namespace has not changed.

Unless otherwise stated, all references to XML elements illustrated in this document are from the ‘cis’ namespace. Elements from other namespaces will be prefixed with the name of the external namespace, e.g. <core:XXXX>.

10. Data Model And Query Support

For query and response messages limited to basic query support, CIS implementations shall support the exchange of name/value pairs, referred to as qualifiers. See [SCTE130-8]. Additionally, a CIS may support any number of external data models and an appropriate connector schema should be defined for each supported data model.

CIS implementations are not required to support any specific data model. All data models and connector schemas described herein are optional. CIS implementations choosing to support one or more data models described in Appendices A, B or C, shall implement the connector schema as described in the respective normative section.

11. CIS Messages

This specification includes a query and a notification model for CIS to endpoint messaging. The model includes associated notification management functions such as registration, deregistration and active registration listing.

The following topics are covered by [SCTE130-8].

- Message format
- XML message carriage
- Transport mechanisms
- Message error handling

This specification considers all aspects defined therein to be normative and applicable herein. See [SCTE130-2] and [SCTE130-8] for additional information.

The CIS message interface shall include the messages defined in [SCTE130-2]. Table 2 identifies additional SCTE 130 Part 4 CIS specific messages.

Table 2 - CIS Top Level Messages

Message	Description
CISListSupportedFeaturesRequest	Request to retrieve a list of CIS supported features
CISListSupportedFeaturesResponse	Response to CISListSupportedFeaturesRequest
CISListQualifiersRequest	Request to list basic query qualifier information
CISListQualifiersResponse	Response to CISListQualifiersRequest
CISListNotificationRegistrationRequest	Request to list existing registrations
CISListNotificationRegistrationResponse	Response to CISListNotificationRegistrationRequest
CISNotificationRegistrationRequest	Registration request for content notification

Message	Description
CISNotificationRegistrationResponse	Response to CISNotificationRegistrationRequest
CISNotification	Notification message indicating asset status change
CISNotificationAcknowledgement	Response to CISNotification
CISCreateCursorRequest	Request to create a cursor
CISCreateCursorResponse	Response to CISCreateCursorRequest
CISCancelCursorRequest	Request to cancel an existing cursor
CISCancelCursorResponse	Response to CISCancelCursorRequest
CISQueryRequest	Request to acquire records from the CIS
CISQueryResponse	Response to CISQueryRequest
CISNotificationDeregisterRequest	Request to de-register a previously accepted registration
CISNotificationDeregisterResponse	Response to CISNotificationDeregisterRequest
CISDeregistrationNotification	Deregistration notification
CISDeregistrationAcknowledgement	Deregistration notification acknowledgement

11.1. @version Attribute

For all SCTE 130 Part 4 messages defined herein (i.e., those messages prefix with the string “CIS”), the @version attribute shall be set to the value “2.0” for this document’s revision. For messages defined by the core namespace, for example core:ServiceStatus and core:ServiceNotification, their @version attribute shall contain the value defined by the normatively referenced specification. See [SCTE130-2] for additional information.

11.2. Request Base Message

All CIS top level request messages are derived from the gis:Msg_RequestBaseType abstract base message type.

11.2.1. Request Base Message Attributes

All request Base Message Attributes are consistent with those listed in [SCTE130-8].

11.2.2. Request Base Message Elements

All Request Base Message Elements are consistent with those listed in [SCTE130-8]

11.3. Response Base Message

All CIS top level response messages are derived from the gis:Msg_ResponseBaseType abstract base message type.

11.3.1. Base Response Message Attributes

All Response Base Message Attributes are consistent with those listed in [SCTE130-8]

11.3.2. Base Response Message Elements

All Response Base Message Elements are consistent with those listed in [SCTE130-8], except those elements listed below in this section.

11.4. Notification Base Message

All CIS top level notification messages are derived from the `gis:Msg_NotificationBaseType` abstract base message type. See the [SCTE130-8] document for details on the attributes and elements contained in this base message.

11.4.1. Notification Base Message Attributes

All Notification Base Message Attributes are consistent with those listed in [SCTE130-8].

11.4.2. Notification Base Message Elements

All Notification Base Message Elements are consistent with those listed in [SCTE130-8].

11.5. Acknowledgement Base Message

All CIS top level acknowledgement messages are derived from the `gis:Msg_AcknowledgementBaseType` abstract base message type. See the [SCTE130-8] document for details on the attributes and elements contained in this base message.

11.5.1. Acknowledgement Base Message Attributes

All Acknowledgement Base Message Attributes are consistent with those listed in [SCTE130-8].

11.5.2. Acknowledgement Base Message Elements

All Acknowledgement Base Message Elements are consistent with those listed in [SCTE130-8].

11.6. Messages Requiring Notification Registration

Registration is required for `CISNotification`, `CISNotificationDeregisterRequest` and `CISDeregistrationNotification` message exchanges. All other CIS messages do not require registration and may be sent at any time.

11.7. CIS Message Exchange

The following diagram illustrates a typical message exchange between a CIS client and the CIS.

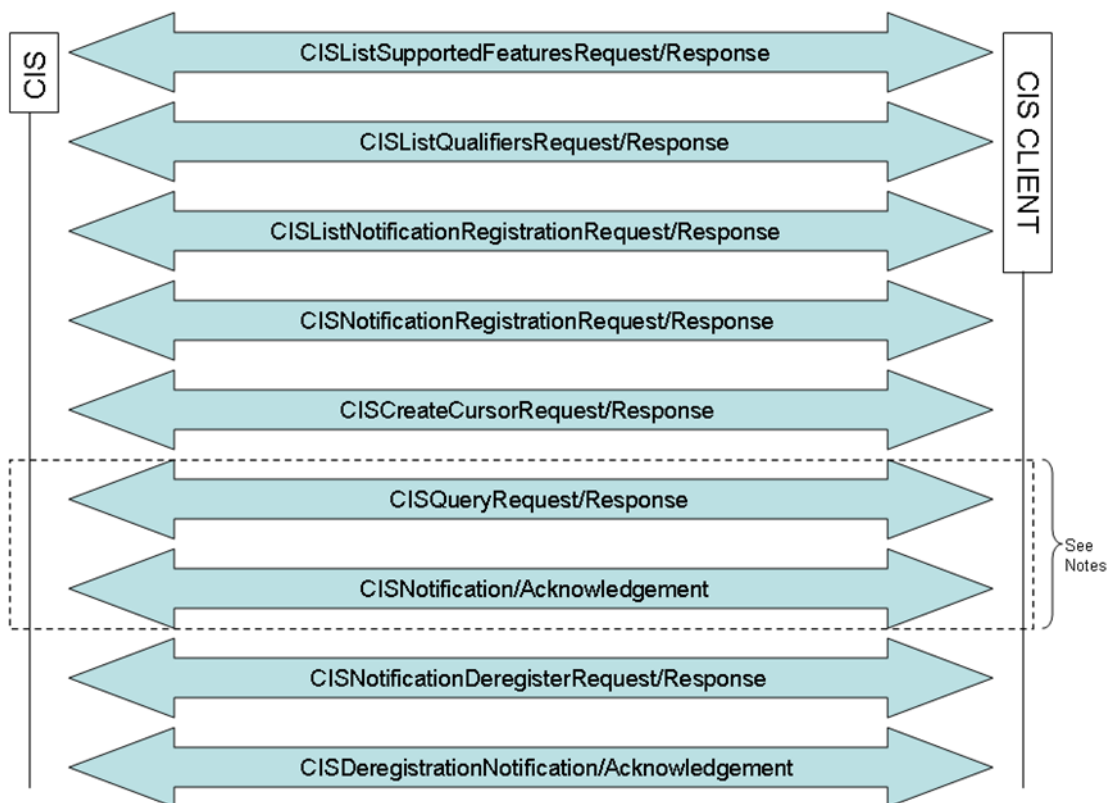

Notes: The CISQuery and Notification exchange can be called or may happen repeatedly between logical service channel setup and tear down.

Figure 3 - CIS Message Exchange

Figure 3 illustrates all of the message exchanges that are specific to the CIS. The core:ServiceCheck and core:ServiceStatus message exchanges are not depicted in this illustration.

11.8. CISListSupportedFeaturesRequest and Response

The CISListSupportedFeatures request and response messages allow clients to inquire about CIS supported data models and advanced query languages.

11.8.1. CISListSupportedFeaturesRequest Message

The CISListSupportedFeatures request message allows a CIS client to inquire about the data models and advanced query languages supported by a CIS. Advanced query language support is optional and thus, the response message may or may not contain information regarding advanced query languages.

The XML schema definition for this message is illustrated in Figure 4.

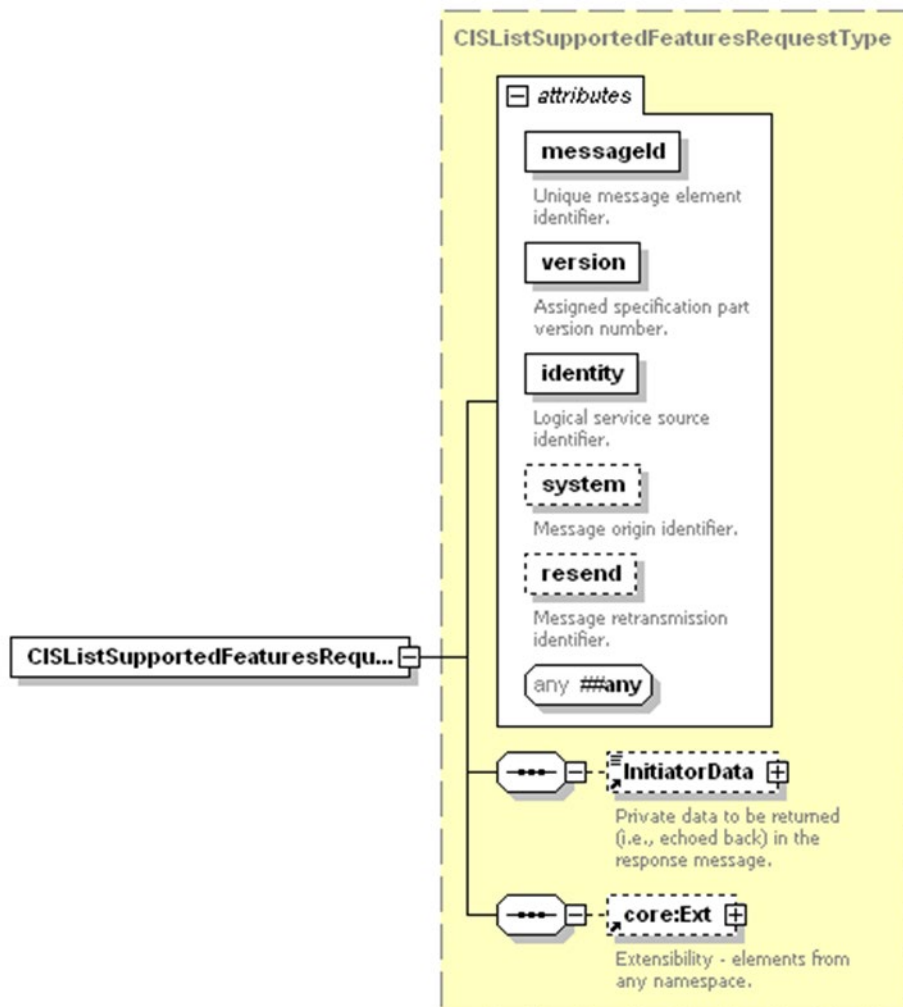

Figure 4 - CISListSupportedFeaturesRequest XML Schema

This CIS interface adds only a single `core:Ext` to the `gis:ListSupportedFeaturesRequestType` defined by [SCTE130-8]. See [SCTE130-8] for additional information.

11.8.2. CISListSupportedFeaturesResponse Message

A successful return status in the `CISListSupportedFeaturesResponse` message indicates the message shall contain at a minimum the following elements.

- A single `core:Callout` element containing one or more `core:Address` element(s) supplying an endpoint for additional services as specified by Table 5. See [SCTE130-2] and [SCTE130-8] for additional information.
- One or more `gis:ServiceDataModelProfile` elements describing a data model supported by a CIS. CIS supported data models are outside the scope of this specification.

The XML schema definition for this message is illustrated in Figure 5.

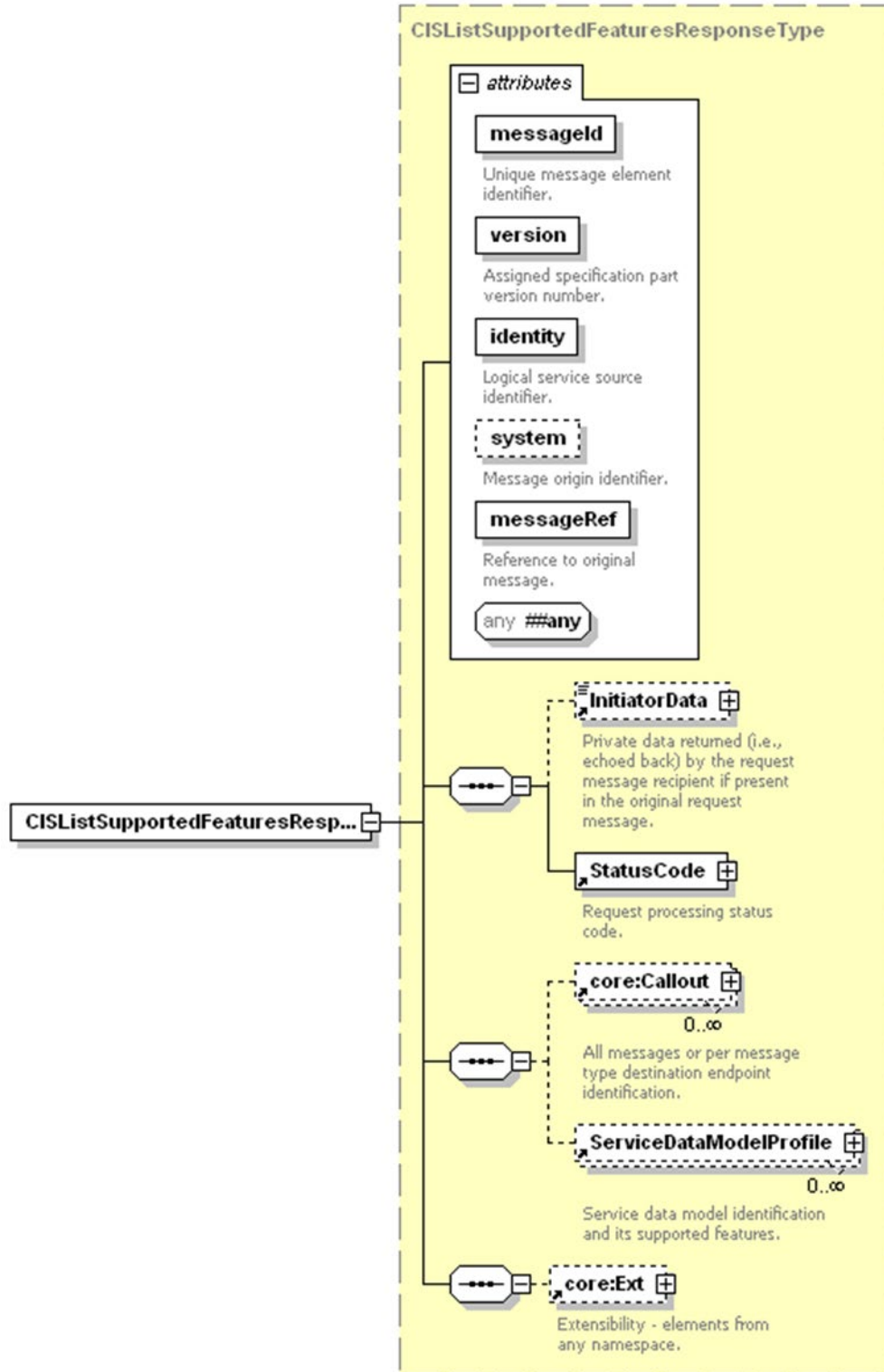

Figure 5 - CISListSupportedFeaturesResponse XML Schema

This CIS interface adds only a single core:ext to the gis:CISListSupportedFeaturesResponseType defined by [SCTE130-8]. See [SCTE130-8] for additional information.

Table 3 contains the values for the @message attribute of the core:Callout element. Values for the @message attribute should be used exactly as defined in this table.

Table 3 - ListSupportedFeatures core:Callout @message values

Value	Description
CISNotificationRegistrationRequest	Destination endpoint for message.
CISNotificationDeregisterRequest	Destination endpoint for message.
CISListQualifiersRequest	Destination endpoint for message.
CISListNotificationRegistrationRequest	Destination endpoint for message.
CISCreateCursorRequest	Destination endpoint for message.
CISCancelCursorRequest	Destination endpoint for message.
CISContentQueryRequest	Destination endpoint for message.
ServiceStatusNotification	Destination endpoint for message.
...	User defined address endpoint outside of the scope of this specification. The string shall be prefixed with the text “private”.

All message values listed in Table 3 and not present in the CISListSupportedFeaturesRequest message’s core:Callout XML element sequence shall be available through the default endpoint, if present. The default endpoint is identified by a core:Callout element not having the @message attribute. See [SCTE130-2] for additional information.

11.9. CISListQualifiersRequest and Response Messages

The CISListQualifiersRequest and CISListQualifiersResponse messages allow clients to discover the asset metadata identifiers associated with a CIS implementation’s service data models, which may be queried with the basic query interface.

11.9.1. CISListQualifiersRequest Message

The CISListQualifiersRequest message allows a CIS consumer to inquire about the qualifier names used by a service data model available for query using the basic query interface.

Figure 6 illustrates the CISListQualifiersRequest message’s schema.

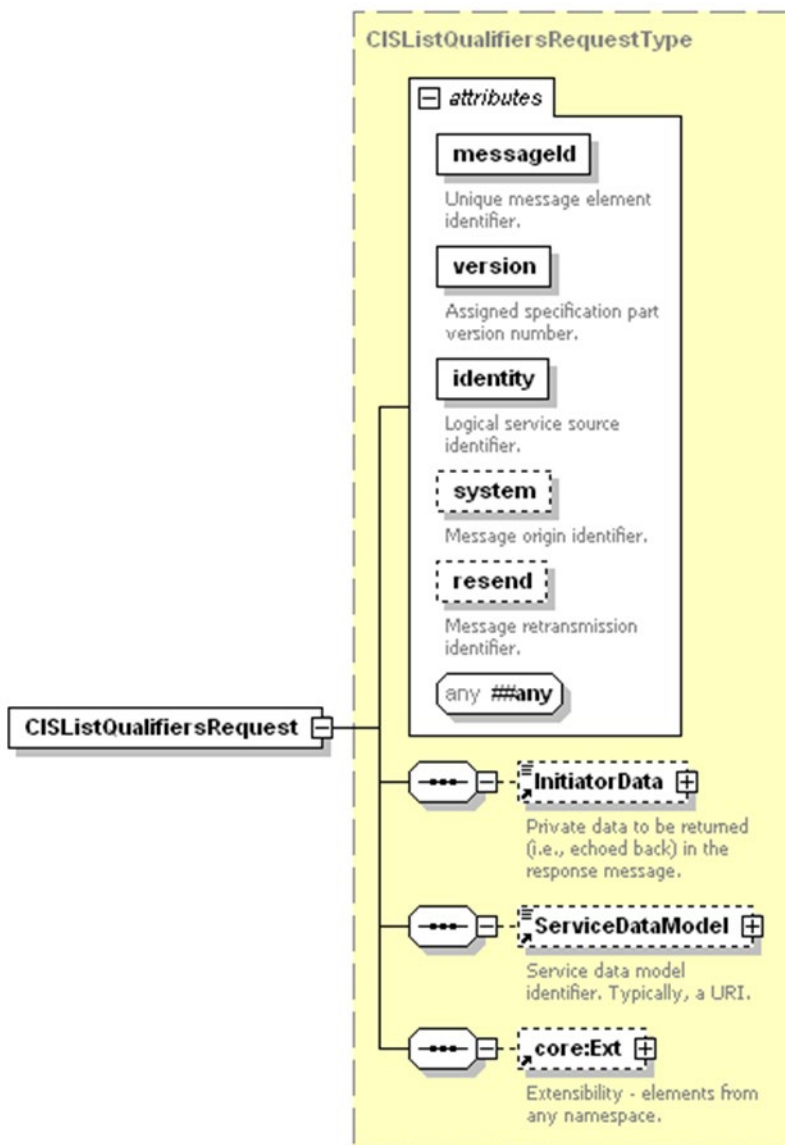

Figure 6 - CISListQualifiersRequest XML Schema

The CIS interface adds only a single core:Ext to the gis:ListQualifiersRequestType defined by [SCTE130-8]. See [SCTE130-8 for additional information.

11.9.2. CISListQualifiersResponse Message

If the CIS implementation supports the service data model specified in the CISListQualifiersRequest message's ServiceDataModel element, the CISListQualifiersResponse message shall contain, at a minimum, a single gis:BasicQueryDataModelDescription element. See [SCTE130-8] for additional information on the gis:BasicQueryDataModelDescription element.

If the CIS implementation does not support the service data model contained in the CISListQualifiersRequest/ServiceDataModel element, no gis:BasicQueryDataModelDescription element shall be returned and the StatusCode element's @detailCode shall be set to core:ResourceNotFound.

The XML schema definition for the CISListQualifiersResponse message is illustrated in Figure 7.

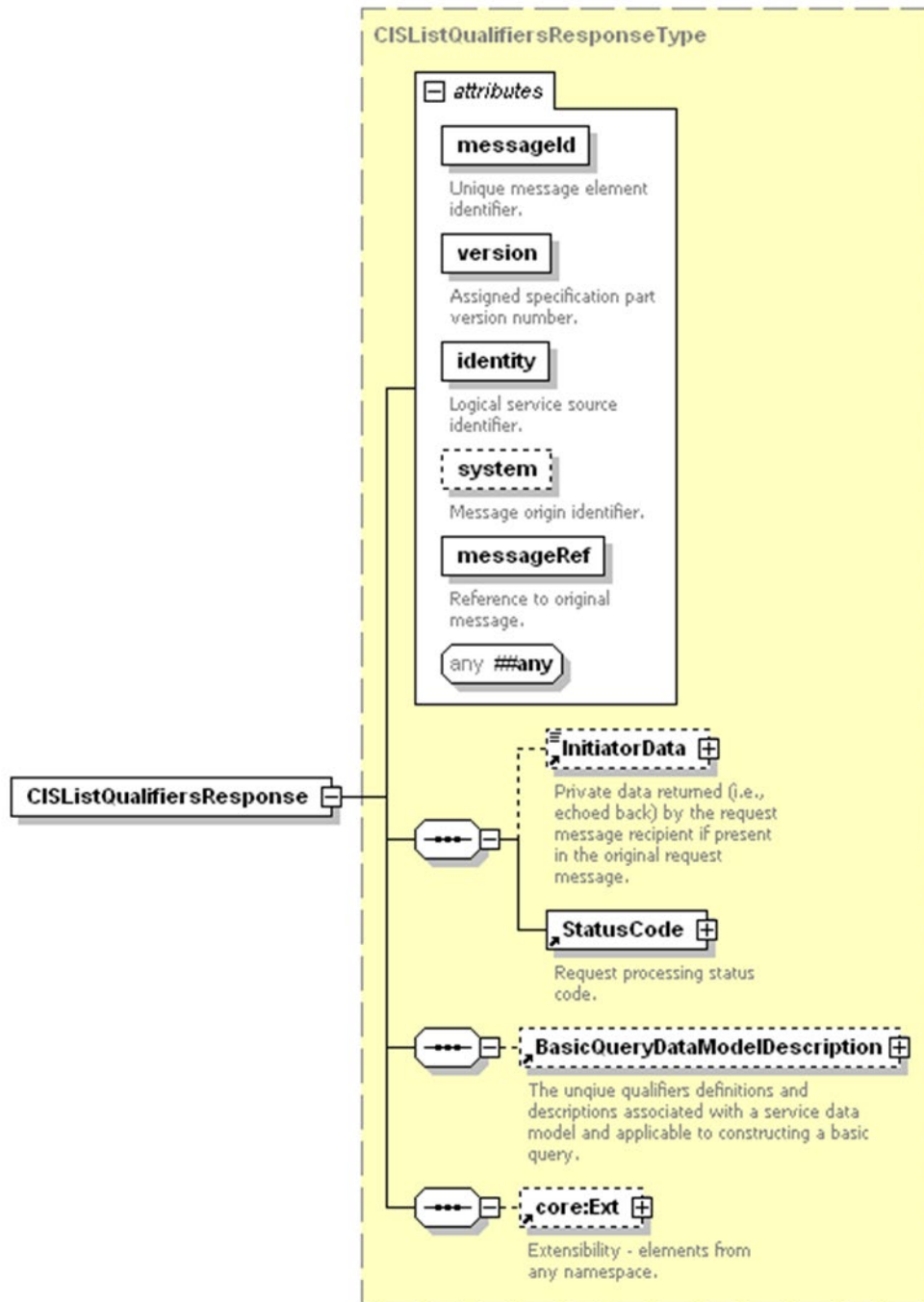

Figure 7 - CISListQualifiersResponse XML Schema

The CIS interface adds only a single core:Ext to the gis:ListQualifiersResponseType defined by [SCTE130-8]. See [SCTE130-8] for additional information.

11.10. CISListNotificationRegistrationRequest and Response

A CIS client may inquire about current registrations by using the CISListNotificationRegistrationRequest message. The CIS shall respond to the CISListNotificationRegistrationRequest message with a CISListNotificationRegistrationResponse message. This allows a CIS client to discover the active notification queries that were previously installed by one or more CISNotificationRegistrationRequest messages.

11.10.1. CISListNotificationRegistrationRequest Message

The CISListNotificationRegistrationRequest message may be issued to a CIS to retrieve information about active CISNotificationRegistrationRequest messages.

The XML schema definition for this message is illustrated in Figure 8.

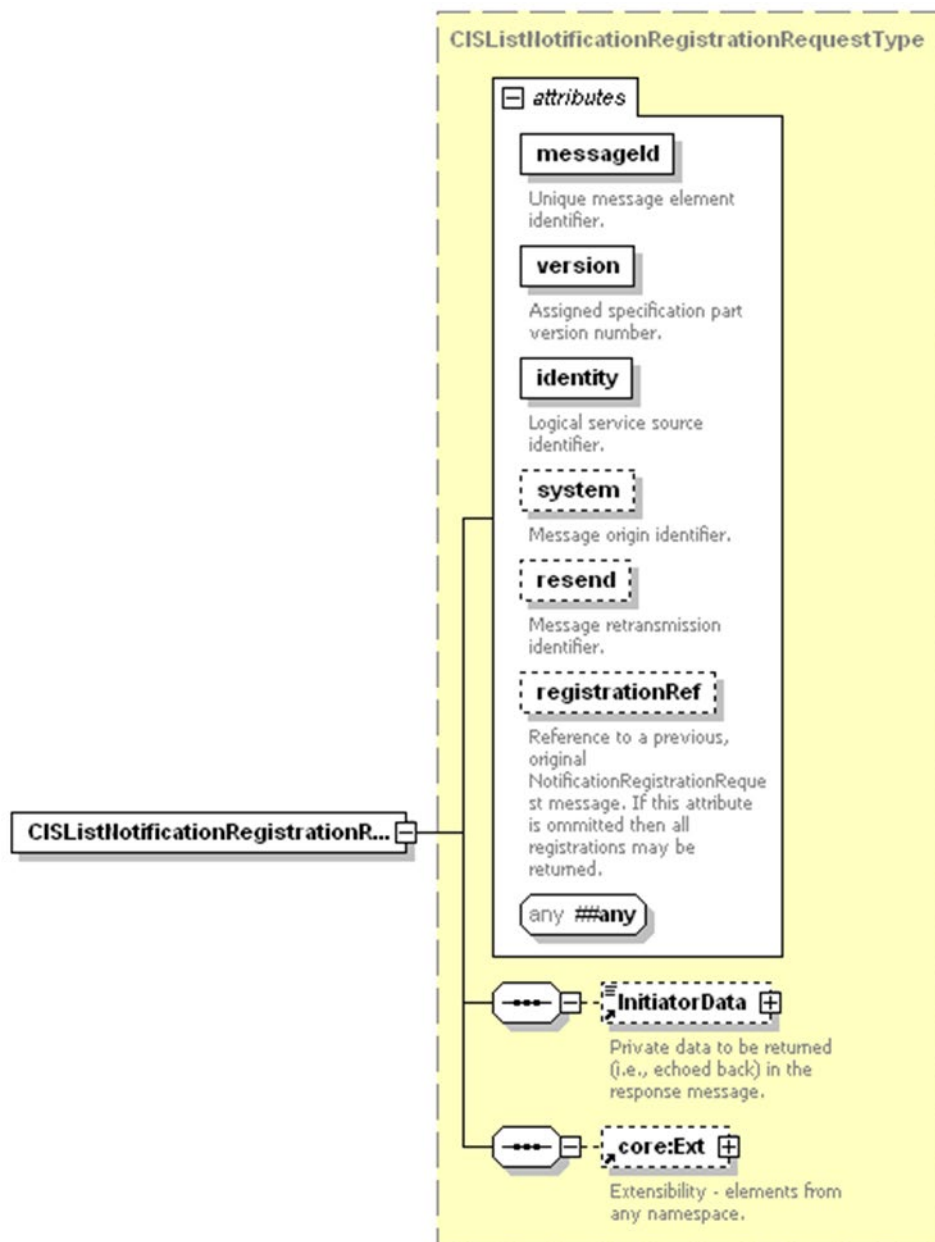

Figure 8 - CISListNotificationRegistrationRequest XML Schema

This CIS interface adds only a single core:Ext to the gis:ListNotificationRegistrationRequestType defined by [SCTE130-8]. See [SCTE130-8] for additional information.

11.10.2. CISListNotificationRegistrationResponse Message

The CISListNotificationRegistrationResponse message is the response pair to the previously defined CISListNotificationRegistrationRequest message. The response message contains the active CISNotificationRegistrationRequest message as appropriate for the inquiry.

The XML schema definition for this message is illustrated in Figure 9.

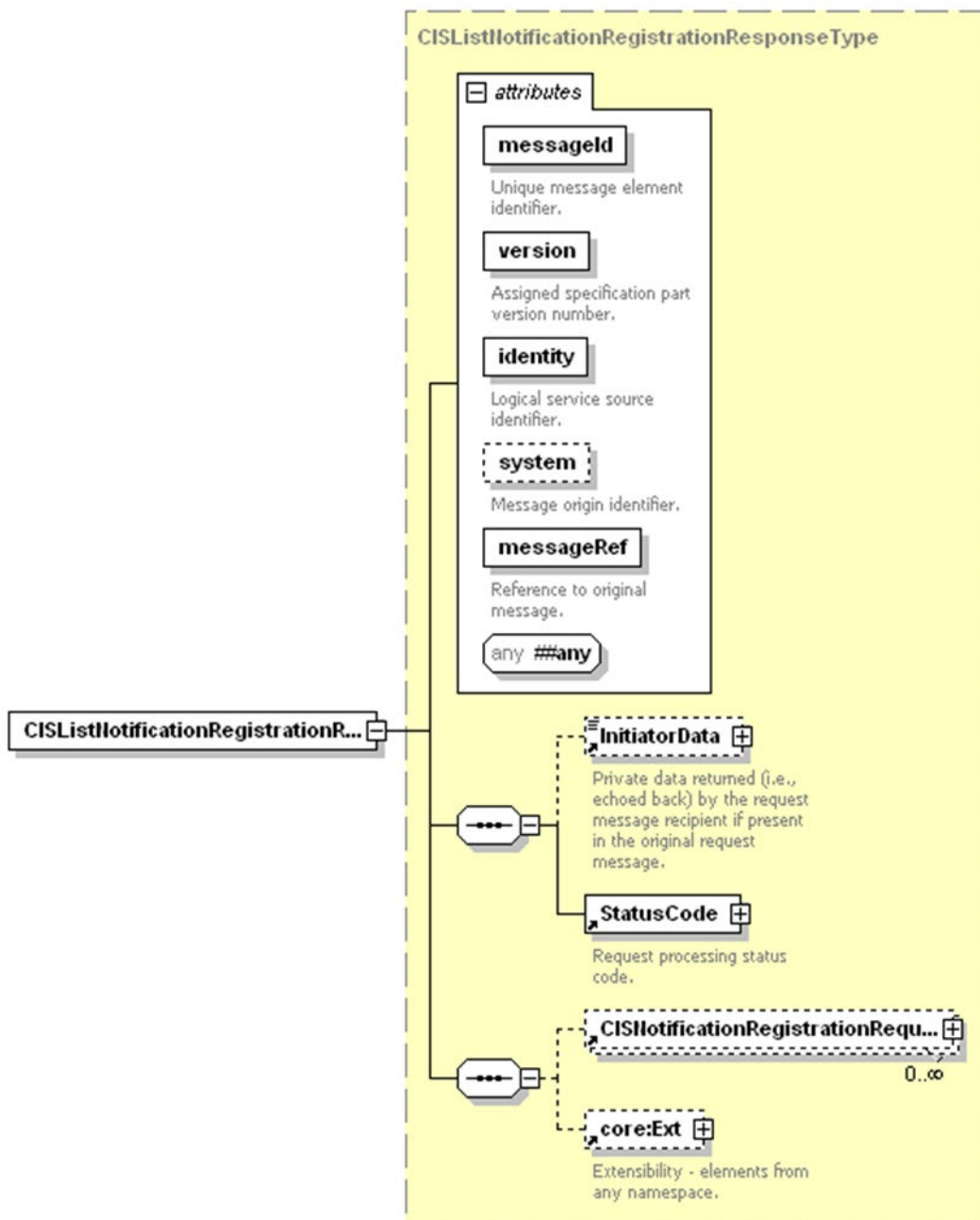

Figure 9 - CISListNotificationRegistrationResponse XML Schema

This CIS interface adds a core:Ext and a cis:CISNotificationRegistrationRequest to the gis:ListNotificationRegistrationResponseType defined by [SCTE130-8]. See [SCTE130-8] for additional information.

CISNotificationRegistrationRequest [Optional] – The CISNotificationRegistrationRequest element shall be a recoded copy of the accepted registration message. The message element order does not convey any information (e.g., element order does not reflect registration order). See Section 11.11.1 for additional information on the CISNotificationRegistrationRequest message.

core:Ext [Optional] –Any additional elements from other namespaces.

11.11. CISNotificationRegistrationRequest and Response

A CIS shall support registration for Notification message delivery as defined by [SCTE130-8]. The CISNotificationRegistrationRequest message enables a client to specify notification interests relative to a selectively defined asset set.

On receipt of an asset update, addition or deletion event from the underlying content store, the CIS shall send a CISNotification message to each matching registered client.

11.11.1. CISNotificationRegistrationRequest Message

The CISNotificationRegistrationRequest message allows a client to specify a set of asset related notification interests. These registered interests shall be examined by the CIS relative to content store changes. If a change to the content store results in a match, a notification containing the result of the matching query shall be sent to the client in the form of a CISNotification message.

The XML schema representation of the CISNotificationRegistrationRequest message is illustrated in Figure 10.

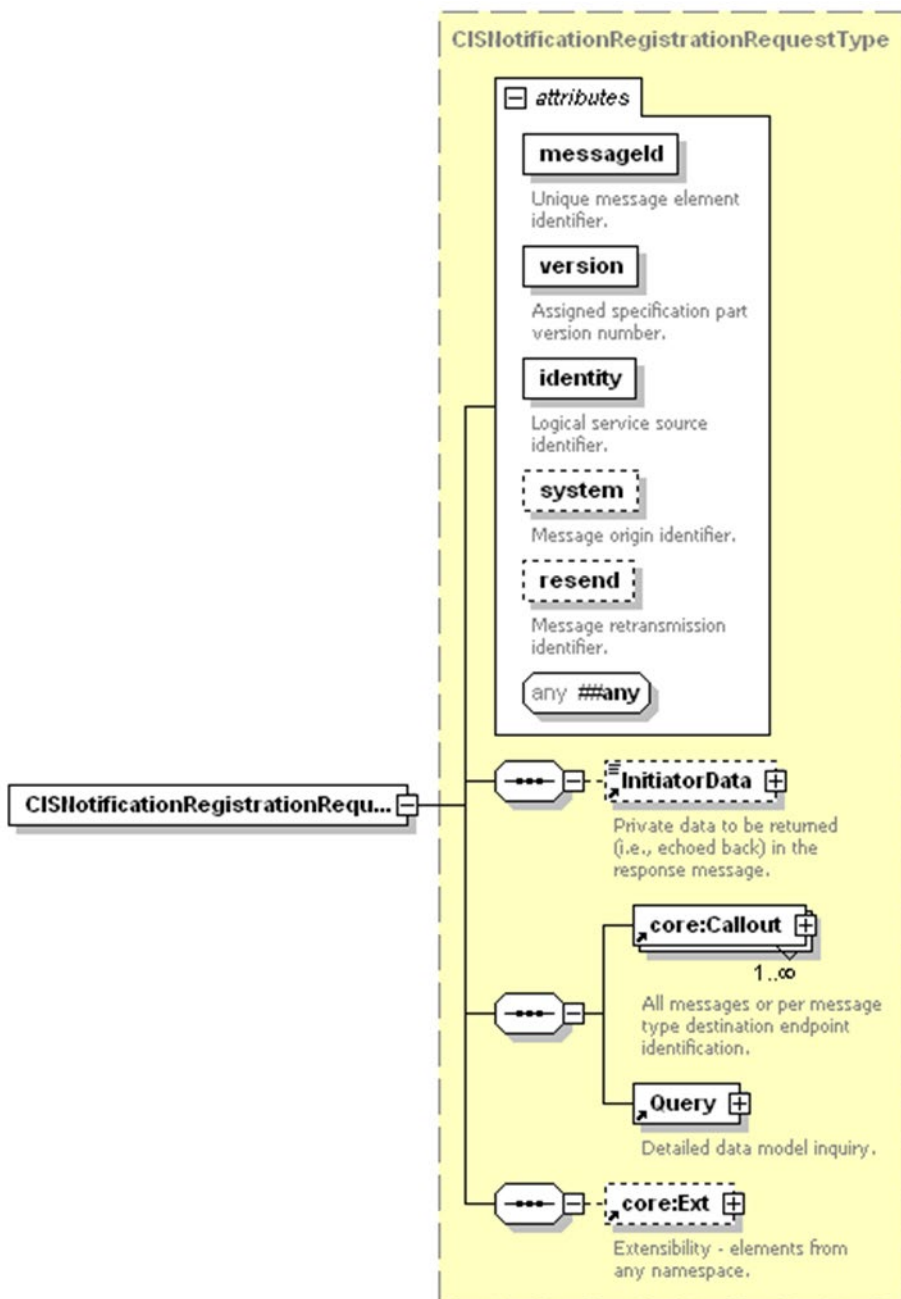

Figure 10 - CISNotificationRegistrationRequest XML Schema

This CIS interface adds a single `core:Ext` to the [SCTE130-8] `gis:NotificationRegistrationRequest`. See [SCTE130-8] for additional information.

Additionally, a CIS implementation shall recognize the values listed in Table 6 as values for the `core:Callout @message` attribute. Values for the `@message` attribute shall appear exactly as defined in this table.

Table 4 - CISNotificationRegistrationResponse core:Callout @message values

@message value	Description
CISNotification	Value associated with the address endpoint where CISNotification messages shall be sent.
ServiceStatusNotification	Value associated with the address endpoint where ServiceStatusNotification messages shall be sent.
CISDeregistrationNotification	Value associated with the address endpoint where CISDeregistrationNotification messages shall be sent.
...	User defined address endpoint outside of the scope of this specification. The string shall be prefixed with the text "private:".

All message values listed in Table 4 and not present in the CISNotificationRegistrationRequest message's core:Callout XML element sequence shall be available through the default endpoint if present. The default endpoint is identified by a core:Callout element not having the @message attribute. See [SCTE130-2] for additional information.

11.11.2. CISNotificationRegistrationResponse Message

Upon completion of processing a CISNotificationRegistrationRequest message, the CIS shall respond with a CISNotificationRegistrationResponse message.

The XML schema diagram for the CISNotificationRegistrationResponse message is as follows in Figure 11.

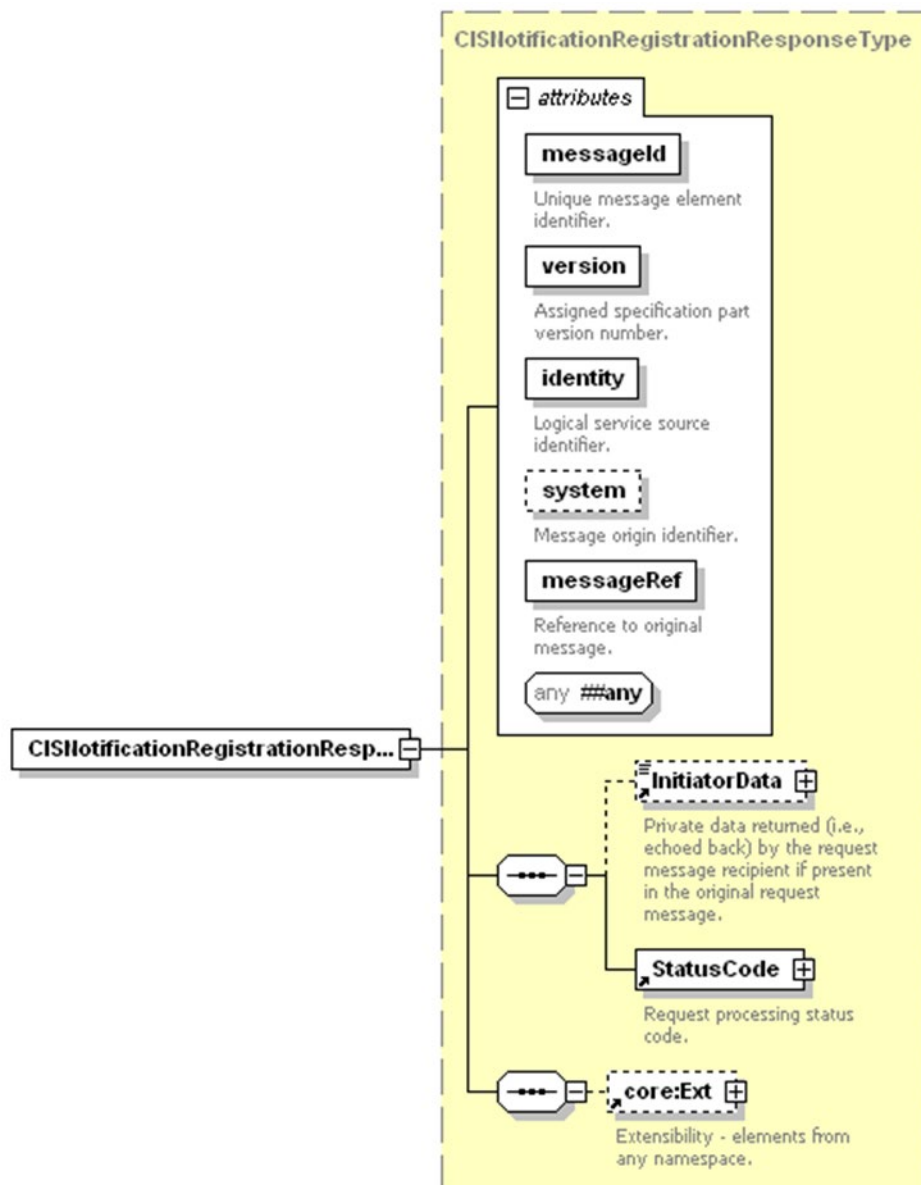

Figure 11 - CISNotificationRegistrationResponse XML Schema

This CIS interface adds only a single `core:Ext` to the `gis:NotificationRegistrationResponseType` defined by [SCTE130-8]. See [SCTE130-8] for additional information.

11.12. CISNotification and Acknowledgement

A CIS shall support the exchange of `CISNotification` and `CISNotificationAcknowledgement` messages with registered consumers for the purpose of notifying the consumer of changes in data relevant to the consumer's registered queries as defined by [SCTE130-8].

11.12.1. CISNotification Message

Upon detection of a change in the result set of one or more queries registered with a CIS implementation, the CIS shall send a `CISNotification` message to qualified, registered clients.

The XML schema for the CISNotification message is illustrated in Figure 12.

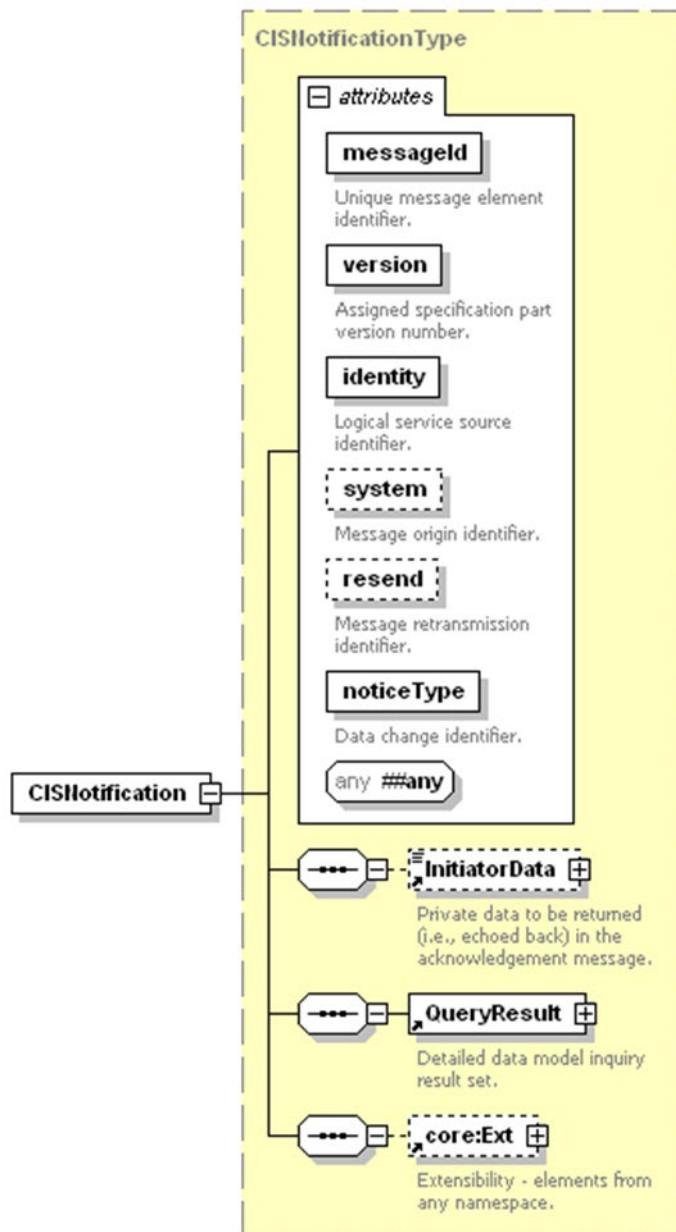

Figure 12 - CISNotification XML Schema

This CIS interface adds only a single core:Ext to the gis:NotificationType defined by [SCTE130-8]. See [SCTE130-8] for additional information.

Note: The gis:BasicQueryResultAbstract element located within the QueryResult element shall be substituted with a data model specific results element which extends from the gis:BasicQueryResultAbstract element. The element present is dependent upon the data model being queried and the query parameters.

11.12.2. CISNotificationAcknowledgement Message

Upon the receipt of a ContentNotification message, a CIS client shall respond with a CISNotificationAcknowledgement message.

The XML schema for the CISNotificationAcknowledgement element is illustrated in Figure 13 - CISNotificationAcknowledgement XML Schema.

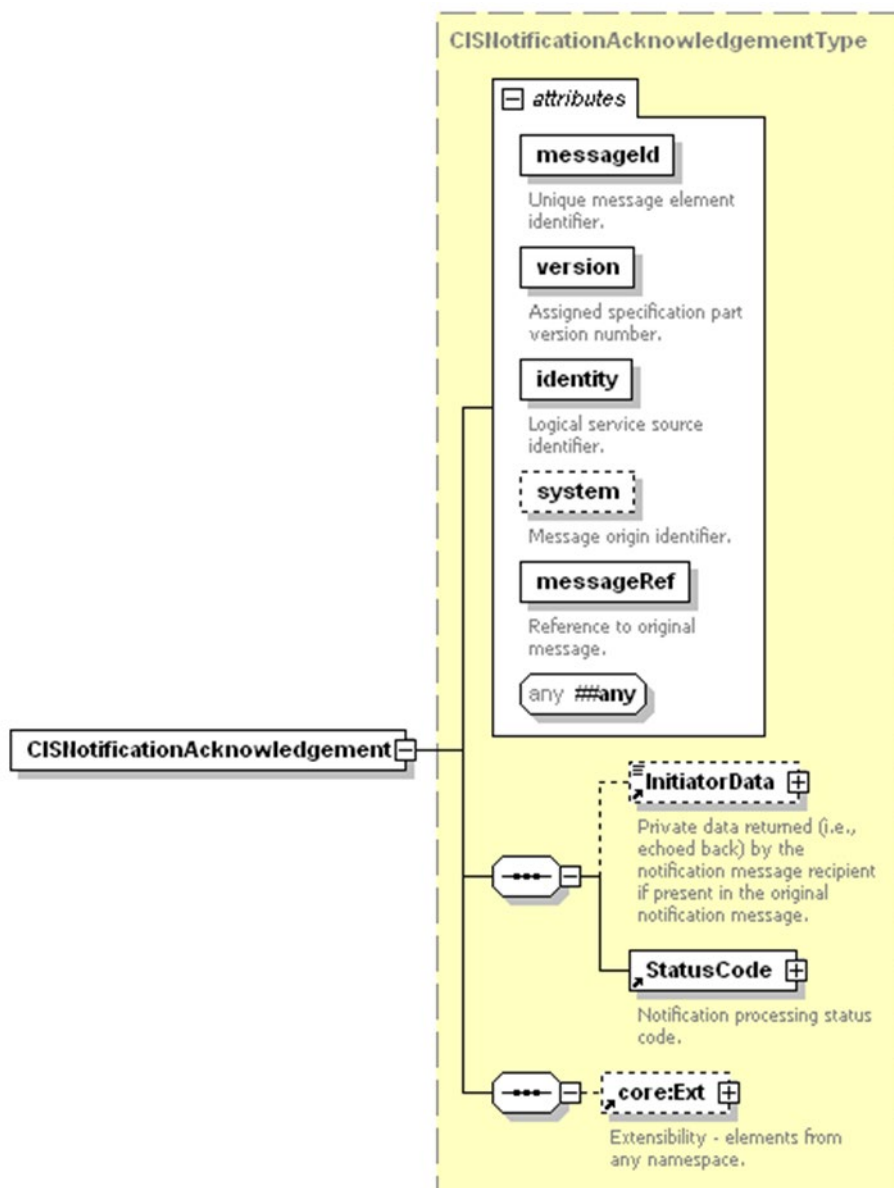

Figure 13 - CISNotificationAcknowledgement XML Schema

This CIS interface adds only a single core:Ext to the gis:NotificationAcknowledgementType defined by [SCTE130-8]. See [SCTE130-8] for additional information.

11.13. CISCreateCursorRequest and Response

A CIS shall support cursors of static asset information for both basic and advanced queries, which shall exist for a specified duration. Upon creation of a cursor on the CIS, the asset information in the cursor shall remain static relative to the referenced content store.

Cursors have a limited life span, which is first requested by the client, but may be overridden by a CIS. As part of the CISCreateCursorRequest message, the client shall specify a @cursorExpires date and time value attribute. This is a request to a CIS for a specific end date and value for the cursor identified by the @cursorId attribute. A CIS, in order to maintain overall system health, may choose to override a requested cursor expires end date and time value and substitute a different, implementation specific, cursor expires end date and time value.

11.13.1. CISCreateCursorRequest Message

The CreateCursorRequest message is used to create an instance of a static cursor on a CIS.

The XML schema for the CISCreateCursorRequest message is listed in Figure 14.

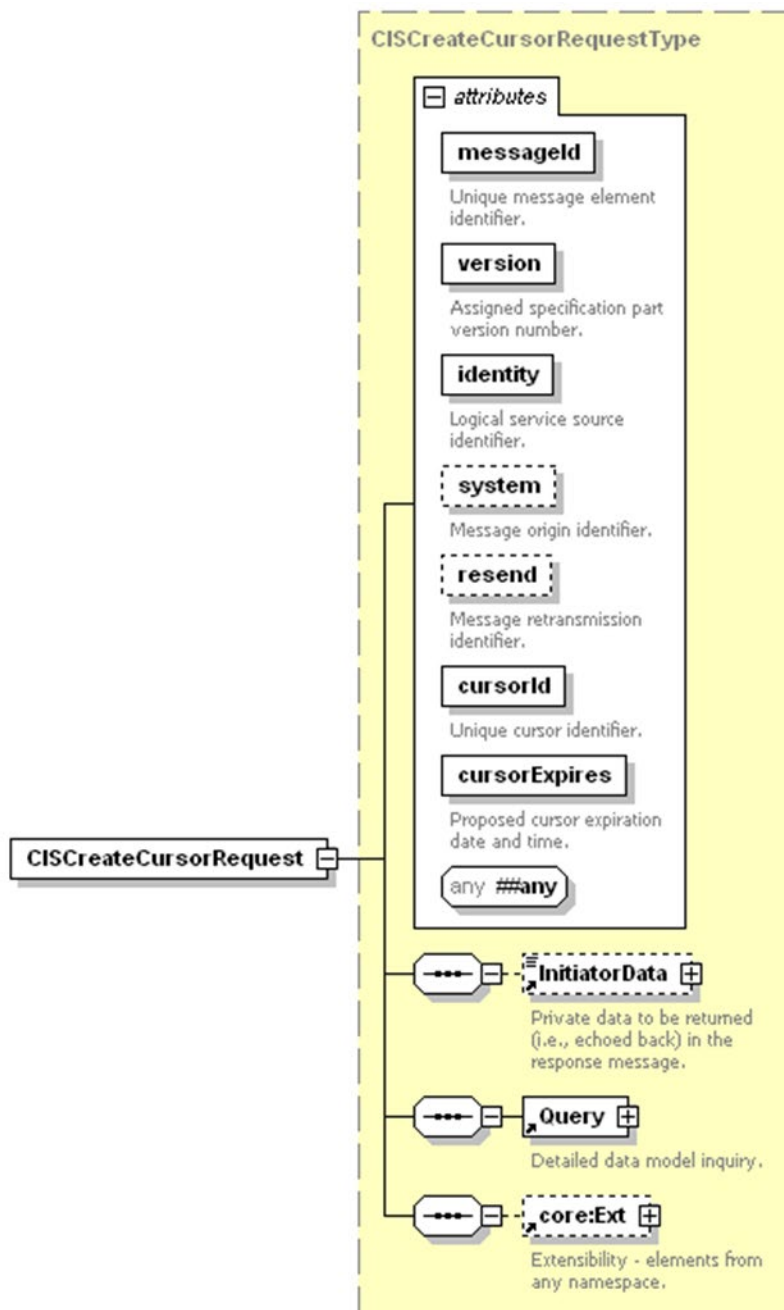

Figure 14 - CreateCursorRequest XML Schema

This CIS interface adds only a single core:Ext to the [SCTE130-8] gis:CreateCursorRequestType. See [SCTE130-8] for additional information.

11.13.2. CISCreateCursorResponse Message

Upon receipt of a CISCreateCursorRequest message, the CIS implementation shall attempt to create the required cursor and shall respond to the client with a CISCreateCursorResponse message. If the query is not successful (i.e., the core:StatusCode value does not equate to success) then the cursor shall not be established.

The XML schema for the CISCreateCursorResponse message is listed in Figure 15.

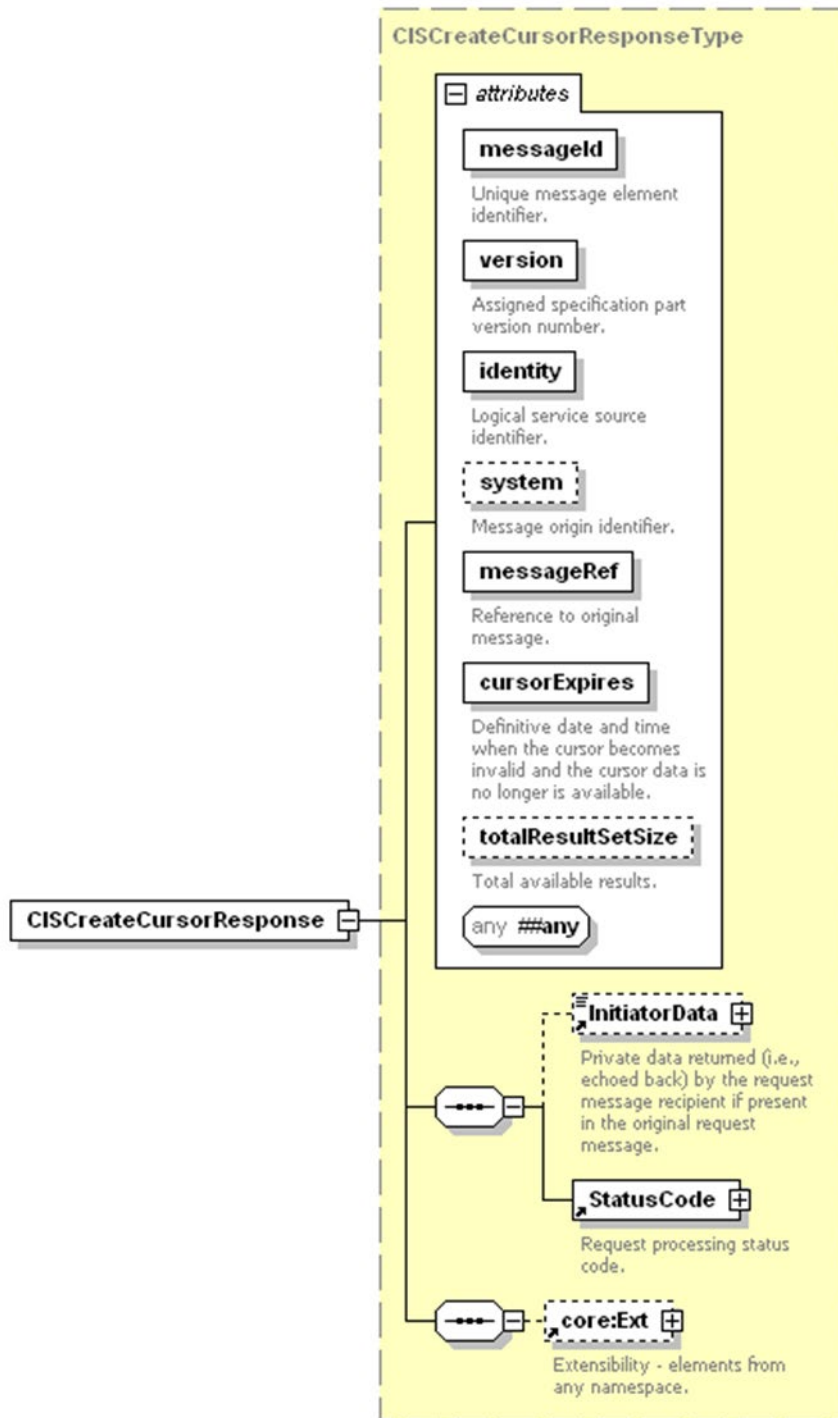

Figure 15 - CreateCursorResponse XML Schema

This CIS interface adds only a single core:Ext to the gis:CreateCursorResponseType defined by [SCTE130-8]. See [SCTE130-8] for additional information.

11.14. CISCancelCursorRequest and Response

A CIS shall allow a client to cancel an existing cursor before the expiration time has passed.

A CIS client may complete interacting with a CIS cursor before the cursor actually expires, and may choose to terminate the CIS cursor. Once a cursor has been terminated or has expired, a CIS may release resources associated with the cursor.

11.14.1. CISCancelCursorRequest Message

This message allows a CIS client to terminate a cursor before the expected cursor expiration time.

The XML schema for the CISCancelCursorRequest message is illustrated in Figure 16.

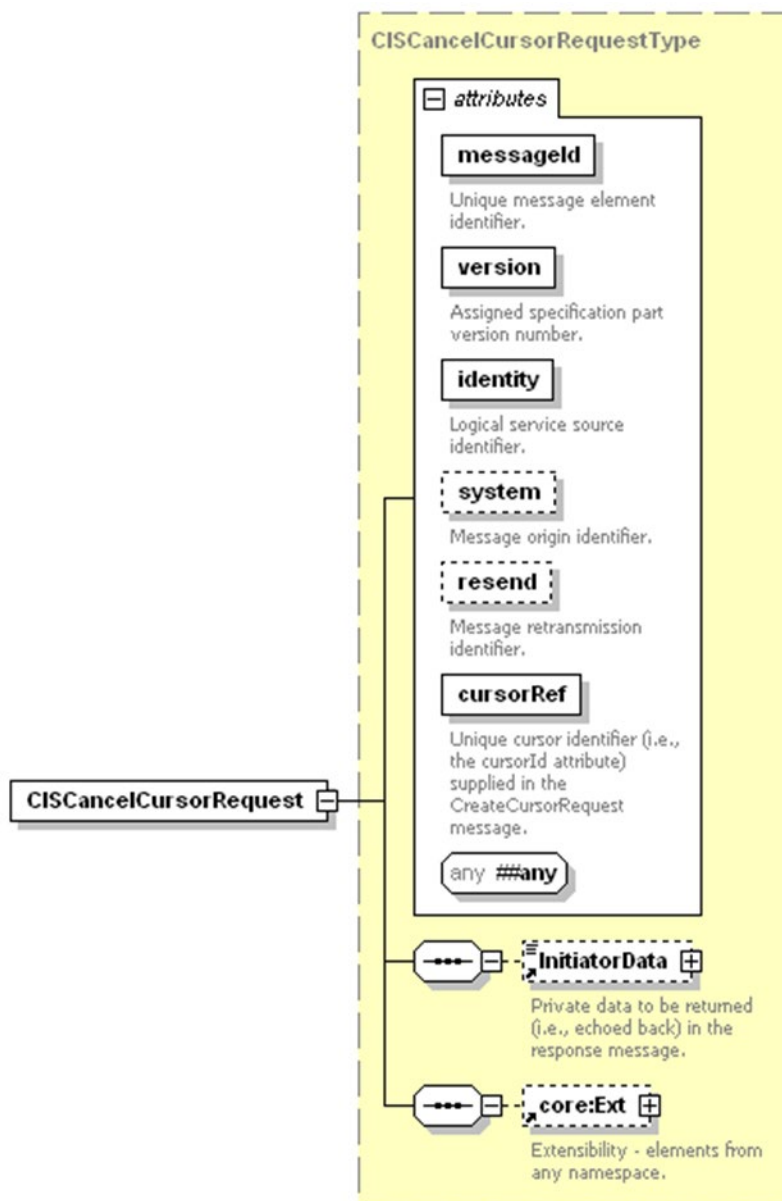

Figure 16 - CISCancelCursorRequest XML Schema

11.14.2. CISCancelCursorResponse Message

Upon receipt of a CISCancelCursorRequest message, the CIS shall terminate the cursor identified by the @cursorRef attribute, and shall return a CISCancelCursorResponse message.

The XML schema for the CancelCursorResponse message is illustrated in Figure 17.

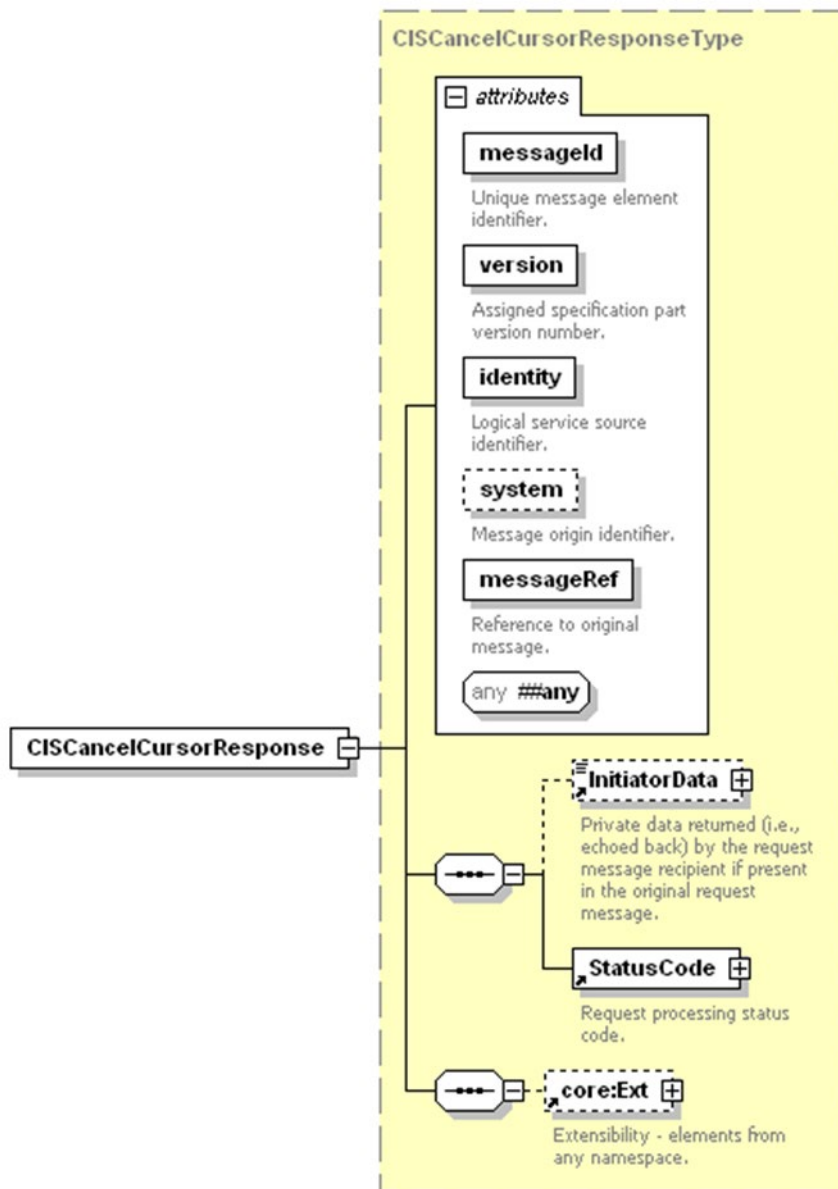

Figure 17 - CISCancelCursorResponse XML Schema

This CIS interface adds only a single core:Ext to the gis:CancelCursorResponseType defined by [SCTE130-8]. See [SCTE130-8] for additional information.

11.15. CISQueryRequest and Response

The CISQueryRequest and CISQueryResponse messages are used by clients to query and receive results against the queried data model. The CISQueryRequest message supports both basic and advanced query mechanisms and references to existing static cursor information.

Basic queries leverage a limited key/value regular expression grammar. Advanced query support should be supported by all CIS implementations. Advanced queries allow for customized queries, using specific query languages, to be executed directly against the CIS data model representation. Results from advanced queries shall be returned to the service consumer without intermediate formatting by a CIS.

11.15.1. CISQueryRequest Message

The CISQueryRequest message is the primary mechanism for a client to execute a query against a CIS implementation's data model. This message contains either a reference to a previously established CIS cursor or a Query element.

The ContentQueryRequest message XML schema definition is illustrated in Figure 18.

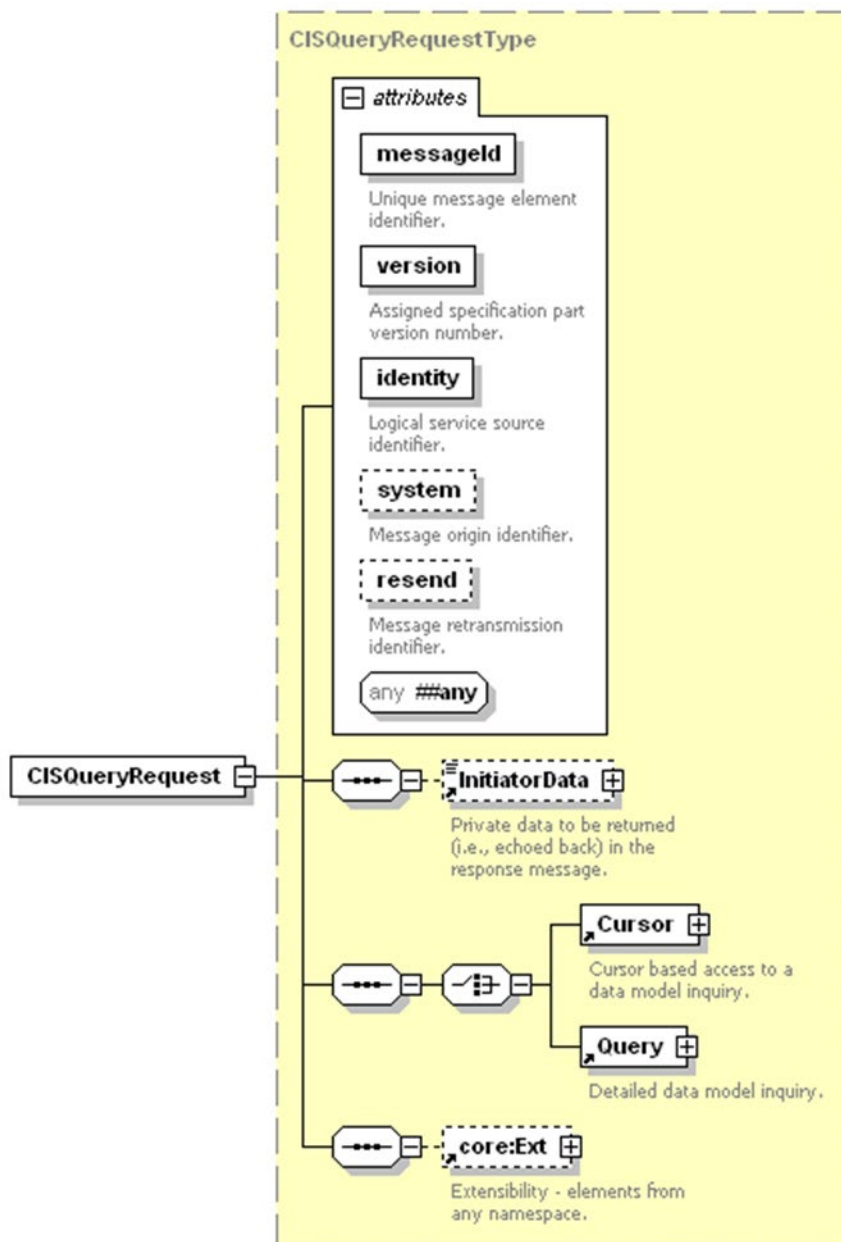

Figure 18 - CISQueryRequest XML Schema

This CIS interface adds only a single core:Ext to the [SCTE130-8] gis:QueryRequestType. See [SCTE130-8] for additional information.

11.15.2. CISQueryResponse Message

Upon receipt of a CISQueryRequest message, the CIS shall respond with a CISQueryResponse message. The response message contains the query results (advanced, basic or cursor) in the QueryResult element.

The XML schema definition for this message is illustrated in Figure 19.

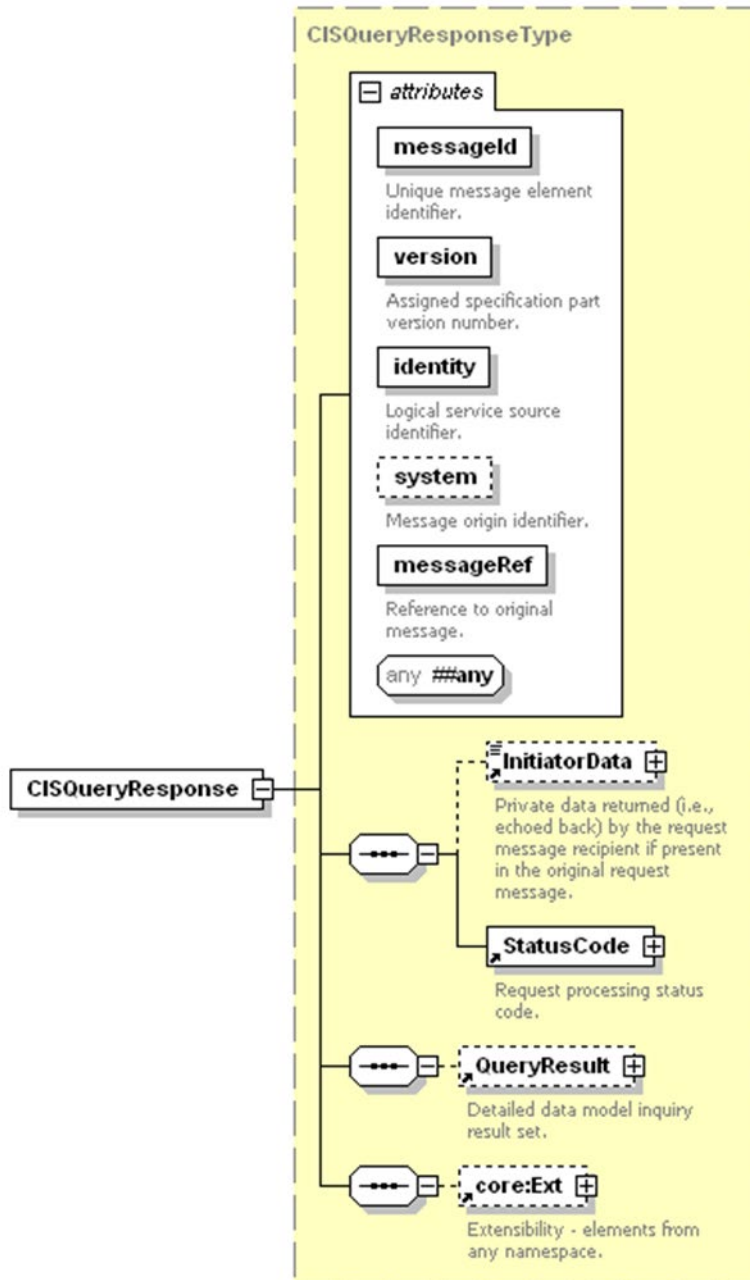

Figure 19 - CISQueryResponse XML Schema

This CIS interface adds only a single core:Ext to the [SCTE130-8] gis:QueryResponseType. See [SCTE130-8] for additional information.

Note: The gis:BasicQueryResultAbstract element located within the QueryResult element shall be substituted with a data model specific results element which extends from the gis:BasicQueryResultAbstract element. The element present is dependent upon the data model being queried and the query parameters.

11.16. CISNotificationDeregisterRequest and Response

A CIS shall allow a client to de-register a previously registered CISNotificationRegistrationRequest message. This message exchange allows a CIS client to dynamically modify registration notifications using individual register and deregister commands.

11.16.1. CISNotificationDeregisterRequest Message

The CISNotificationDeregisterRequest message removes an existing notification registration from the CIS.

The XML schema for the CISNotificationDeregisterRequest message is illustrated in Figure 20.

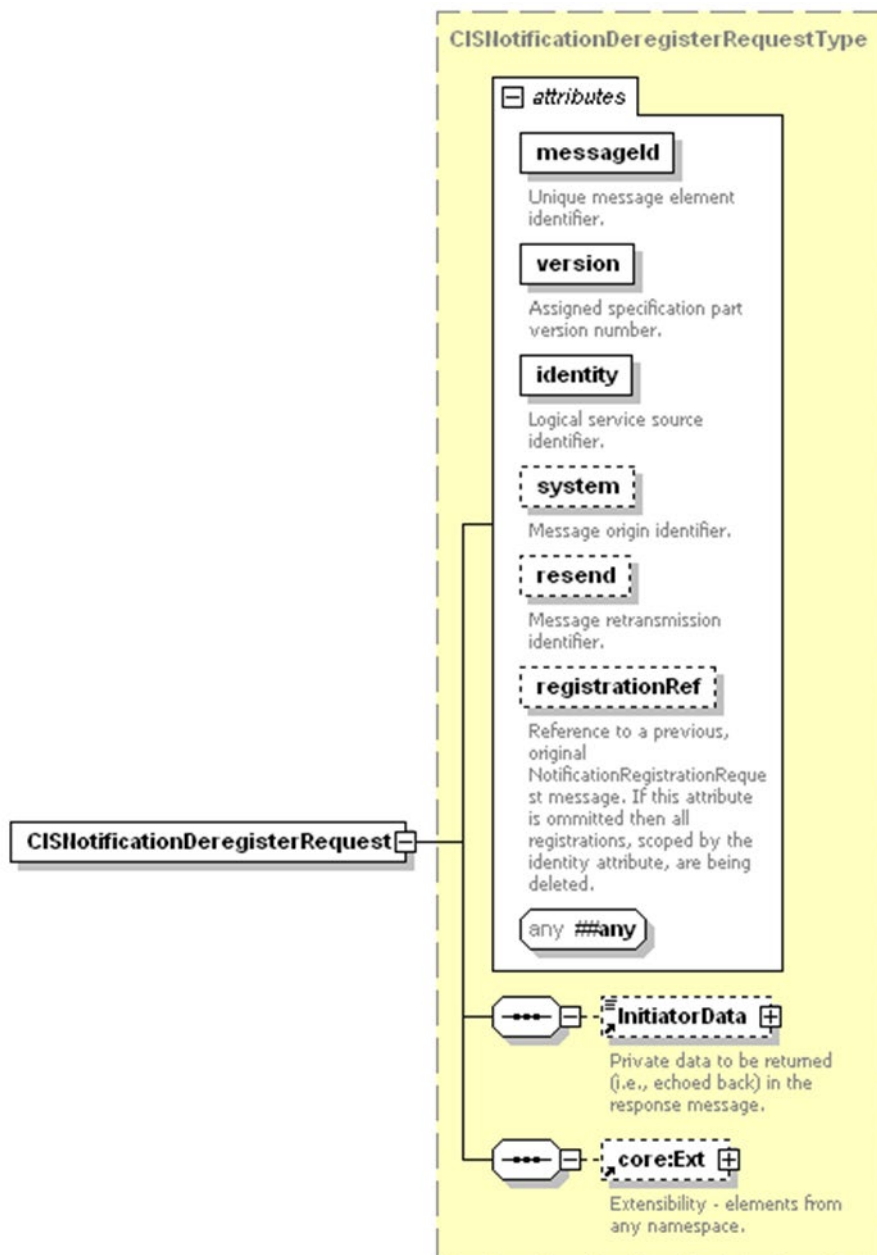

Figure 20 - CISNotificationDeregisterRequest XML Schema

This CIS interface adds only a single core:Ext to the gis:NotificationDeregisterRequestType defined by [SCTE130-8]. See [SCTE130-8] for additional information.

11.16.2. CISNotificationDeregisterResponse Message.

Upon receipt of a CISNotificationDeregisterRequest message from a client, the CIS implementation shall respond with a CISNotificationDeregisterResponse message.

The XML schema for the CISNotificationDeregisterResponse message is illustrated in Figure 21.

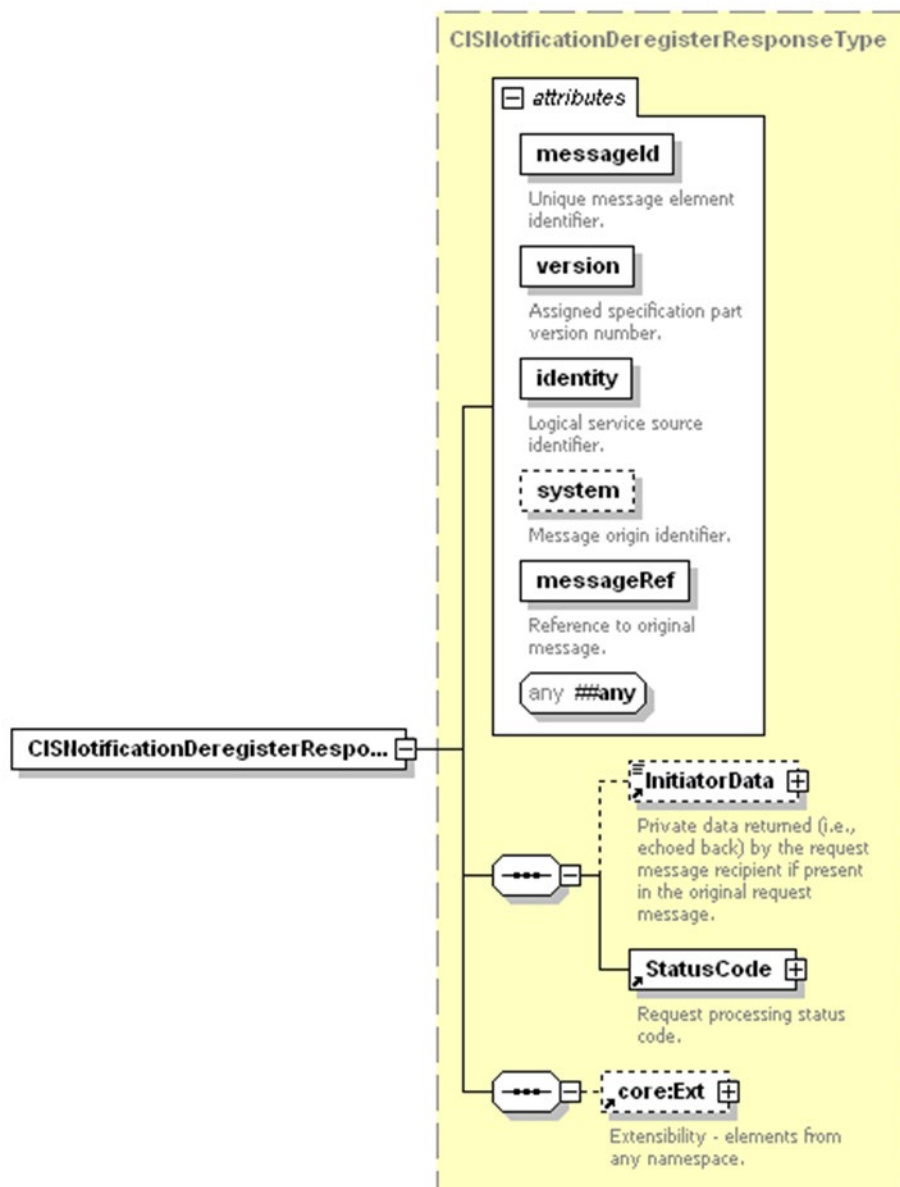

Figure 21 - CISNotificationDeregisterResponse XML Schema

This CIS interface adds only a single `core:Ext` to the `gis:NotificationDeregisterResponseType` defined by [SCTE130-8]. See [SCTE130-8] for additional information.

11.17. CISDeregistrationNotification and Acknowledgement

A CIS implementation shall have the ability to deregister clients. Deregistration removes client registrations from the system and stops any notification traffic from being sent to the deregistered client.

Upon receipt of a `CISDeregistrationNotification` message, a CIS client shall reply with a `CISDeregistrationAcknowledgement` message.

11.17.1. CISDeregistrationNotification Message

At any time, a CIS may issue one or more CISDeregistrationNotification messages to registered CIS clients. This informs the client that one or all of their active registrations (i.e., CISNotificationRegistrationRequest messages) have been terminated and no further notifications shall be expected related to those registrations.

The XML schema for the CISDeregistrationNotification element is illustrated in Figure 22.

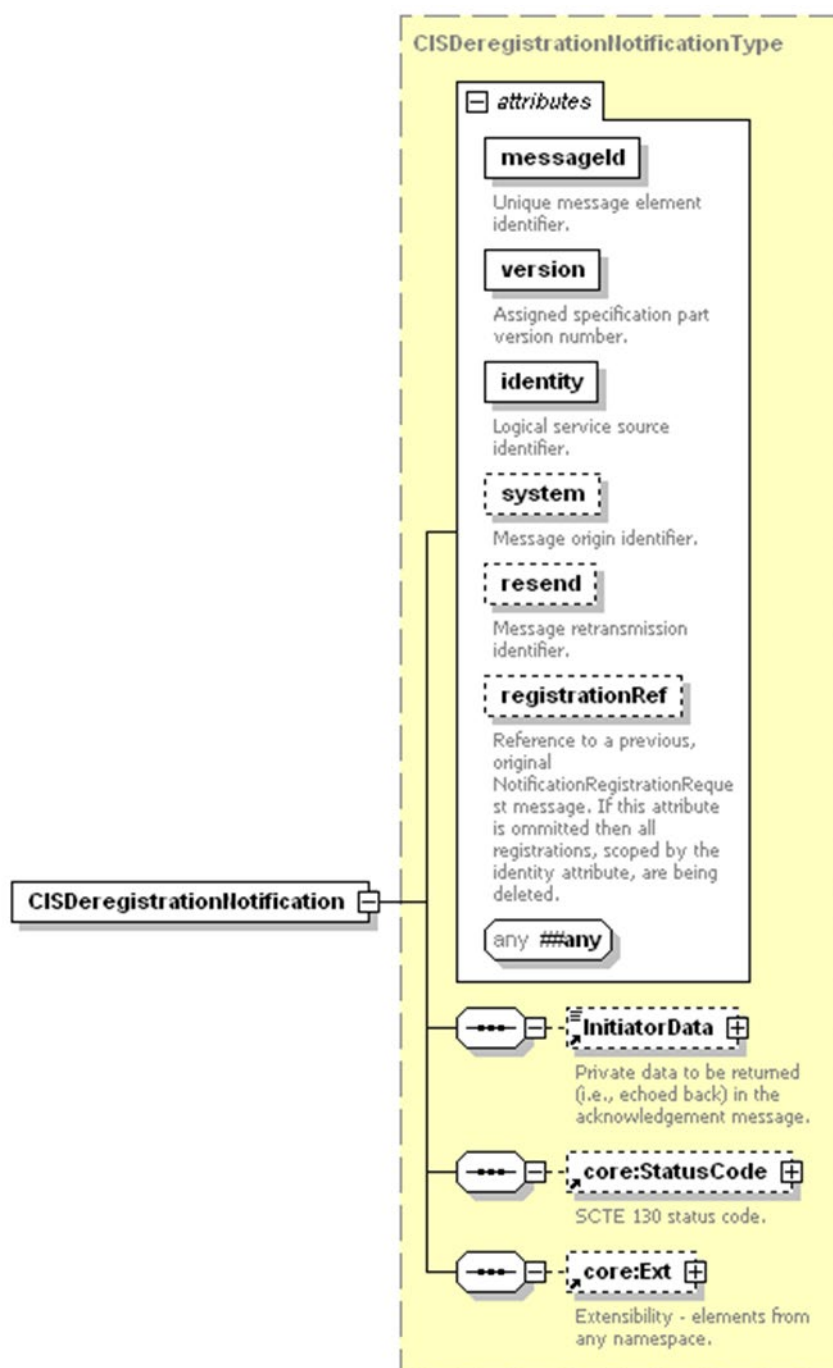

Figure 22 - CISDeregistrationNotification XML Schema

This CIS interface adds only a single core:Ext to the gis:DeregistrationNotification defined by [SCTE130-8]. See [SCTE130-8] for additional information.

11.17.2. CISDeregistrationAcknowledgement Message

Upon receipt of a CISDeregistrationNotification message, a CIS client shall respond with a CISDeregistrationAcknowledgement message. This message informs the CIS that the notification message was received by the intended client and processed.

The XML schema for the CISDeregistrationAcknowledgement element is illustrated in Figure 23.

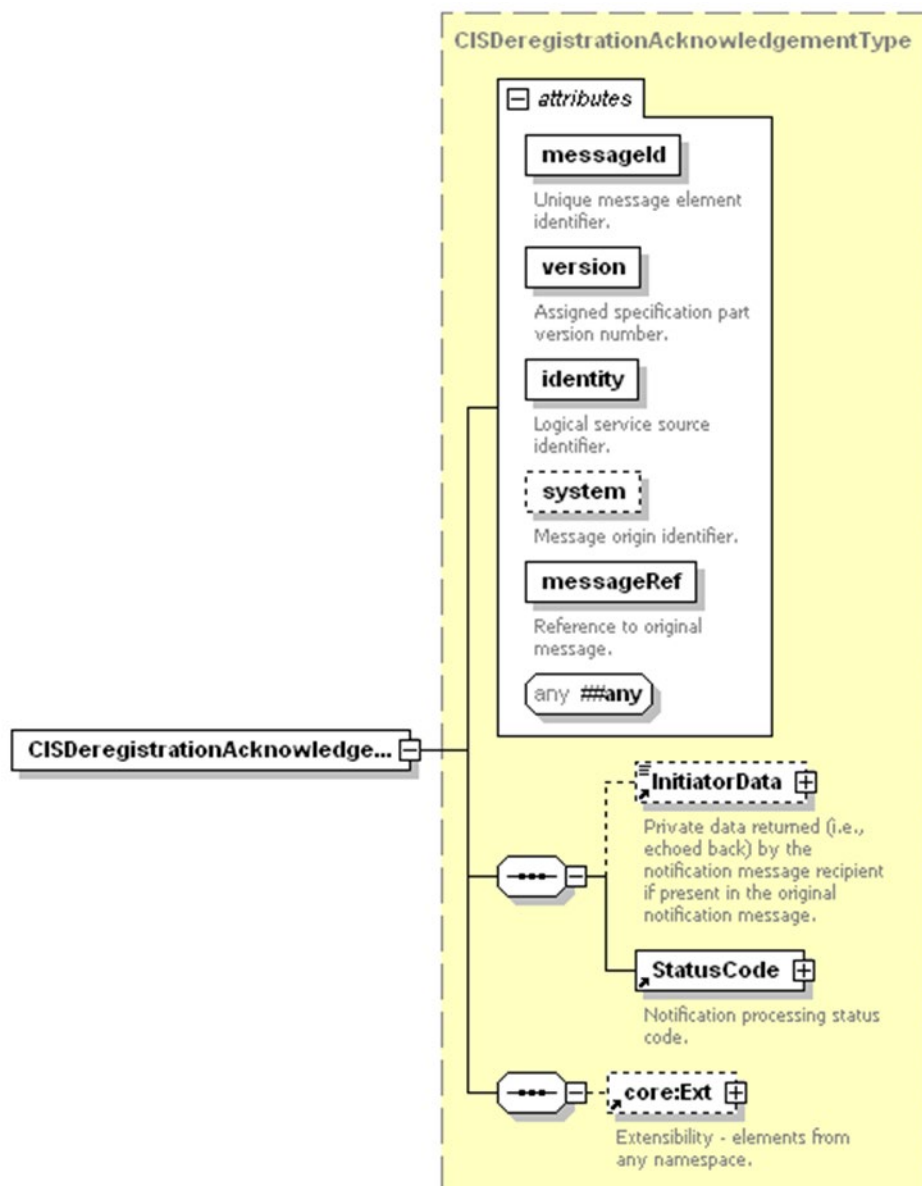

Figure 23 - CISDeregistrationAcknowledgement XML Schema

This CIS interface adds only a single core:Ext to the gis:DeregistrationAcknowledgement defined by [SCTE130-8]. See [SCTE130-8] for additional information.

11.18. Service Check Support

A CIS implementation shall support the ServiceCheck message exchange, which includes the core:ServiceCheckRequest and core:ServiceCheckResponse messages as defined by [SCTE130-2].

11.19. Service Status Support

A CIS implementation shall support the ServiceStatus message exchange, which includes the core:ServiceStatusNotification and core:ServiceStatusAcknowledgement messages as defined by [SCTE130-2].

11.20. CIS Attribute Types

A CIS implementation shall be built using the General Information Service (GIS) interface defined by [SCTE130-8]. The CIS defines no attributes in addition to those already defined by the General Information Service [SCTE130-8].

11.21. CIS Elements

A CIS implementation shall be built using the General Information Service (GIS) interface defined by [SCTE130-8]. The CIS defines no elements in addition to those already defined by the General Information Service [SCTE130-8].

Appendix A CableLabs VOD Metadata 1.1 Data Model Connector (Normative)

The following data model connector is optional. If a CIS implementation chooses to offer this specific data model implementation, this appendix shall be required and all contents shall be considered normative.

A.1 Normative References

[CLVOD-1.1]	CableLabs® VOD Content Specification Version 1.1 MD-SP-VOD-CONTENT1.1-I06-091229. December 29, 2009
-------------	---

Table 5 - VOD Metadata 1.1 Data Model Connector Normative References

A.2 ServiceDataModel URL

A CIS implementation offering this data model shall include the `gis:ServiceDataModel` URL, as defined in Table 6, within the `CISListSupportedFeaturesResponse` message previously defined in section 11.8.

Table 6 - `gis:ServiceDataModel` Definition for VOD Metadata 1.1 Data Model Connector

<code>gis:ServiceDataModel</code> URL	Description
CLVOD_1.1/SCTE/V1	The <code>gis:ServiceDataModel</code> URL value required when CIS output shall contain the VOD Metadata 1.1 Data Model Connector results (i.e., the <code>VOD11BasicQueryResult</code> element) substituted for the <code>gis:BasicQueryResultAbstract</code> element.

The `gis:ServiceDataModel` value shall also be used in the `gis:Query` element of the `CISQueryRequest` message, if the desired output should include the `VOD11BasicQueryResult` substitute element substituted for the `gis:BasicQueryResultAbstract`.

A.3 Unique Qualifiers

VOD Metadata 1.1 Data Model Connector implementations shall support a compound unique qualifier comprised of two qualifier declarations for [CLVOD-1.1] queries. The `@uniqueQualifierName` attribute of the `gis:UniqueQualifierDeclaration` element shall be the value "PAID" and the name attributes of the `gis:QualifierDeclarations` shall be "Asset_ID" and "Provider_ID". These values match the Metadata names for the `Asset_ID` and `Provider_ID` metadata items defined in [CLVOD-1.1].

Example 1 contains a unique qualifier declaration for the name "PAID" comprised of two qualifier declarations containing the names "Asset_ID" and "Provider_ID".

```
<gis:UniqueQualifierDeclaration uniqueQualifierName="PAID">
  <gis:QualifierDeclaration name="Asset_ID"/>
  <gis:QualifierDeclaration name="Provider_ID"/>
</gis:UniqueQualifierDeclaration>
```

```

<gis:QualifierDescription description="Asset ID" name="Asset_ID" valueType="string">
  <gis:MaxLength>20</gis:MaxLength>
</gis:QualifierDescription>

<gis:QualifierDescription description="Provider ID" name="Provider_ID" valueType="string">
  <gis:MaxLength>20</gis:MaxLength>
</gis:QualifierDescription>

```

Example 1: VOD Metadata 1.1 Data Model Unique Qualifiers

CISQueryRequest messages utilizing the gis:ServiceDataModel, defined in Table 6, to query for specific [CLVOD-1.1] metadata assets shall use the unique qualifier declaration defined herein.

A.4 Query and Response

Basic query CISQueryRequest messages utilizing the gis:ServiceDataModel URL defined in Table 6 shall result in CISQueryResult messages containing VOD11BasicQueryResult elements substituted for gis:BasicQueryResultAbstract elements.

Advanced queries are not supported by the VOD Metadata 1.1 Data model Connector. Consequently, the gis:Query element's gis:AdvancedQueryFilter element and the gis:QueryResult element's gis:AdvancedQueryResult element shall be omitted when the gis:Query element of the CISQueryRequest contains the gis:ServiceDataModel URL defined in Table 6.

A.5 Query Semantics

When the @expandOutput attribute of a Query element is set to false, the core:Content element of the resulting VOD11BasicQueryResult element shall contain a core:AssetRef element. When the @expandOutput attribute is set to true, the core:Content element shall contain a well formed [CLVOD-1.1] document within the core:Ext element in addition to a core:AssetRef element. Table 7 defines when specific elements of the core:Content element are to be used in the context of the VOD Metadata 1.1 Data Model Connector.

Table 7 - @expandOutput Options for the VOD Metadata 1.1 Data Model Connector

@expandOutput Value	core:Content Required Elements
true	core:AssetRef core:Ext containing a [CLVOD-1.1] instance document
false	core:AssetRef

The XML schema for the VOD11BasicQueryResult element is illustrated in Figure 24.

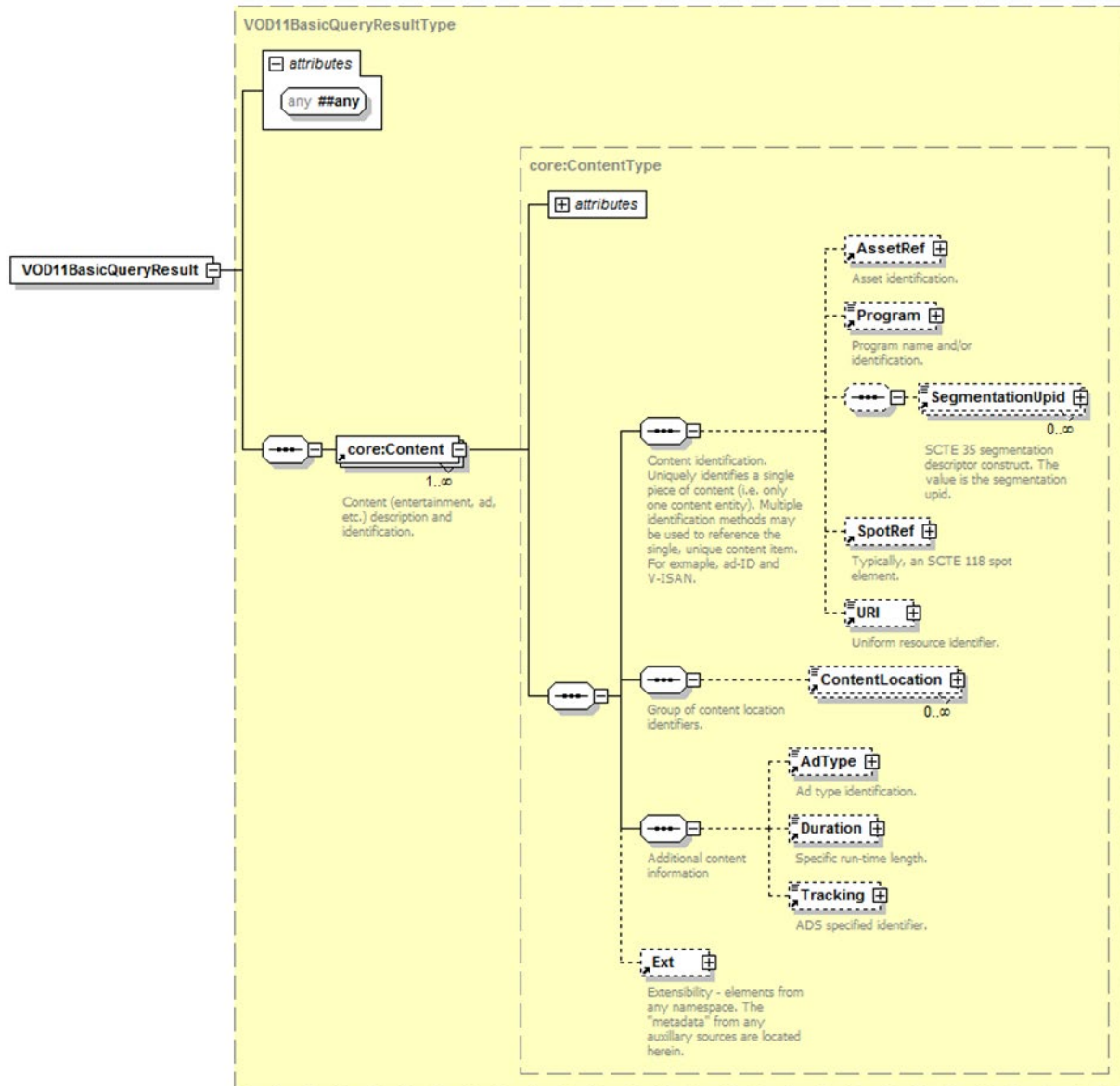

Figure 24 - VOD Metadata 1.1 Data Model Connector XML Schema

Appendix B SCTE 236 Metadata Data Model Connector (Normative)

The SCTE 236⁶ data model connector is optional. If a CIS implementation chooses to offer this specific data model implementation, this appendix shall be required and all contents shall be considered normative.

B.1 XML Namespaces

This data model connector contains elements that use the ‘adi3’ prefix for the interface associated with the specific XML namespace URI that shall be used by all implementations of this connector. Table 8 lists the prefix, the corresponding namespace, and a description of the defining specification used herein.

Prefix	Namespace	Description
adi3	http://www.scte.org/schemas/236/2017/core	See [SCTE236]

Table 8 – SCTE 236 Metadata Data Model Connector Namespaces

B.2 Normative References

[SCTE236]	SCTE 236 Content Metadata
-----------	---------------------------

Table 9 – SCTE 236 Metadata Data Model Connector Normative References

B.3 ServiceDataModel URL

A CIS implementation offering this data model shall include the `gis:ServiceDataModel` URL, as defined in Table 10, within the `CISListSupportedFeaturesResponse` message previously defined in section 11.8.

Table 10 - `gisServiceDataModel` Definition for SCTE 236 Data Model Connector

<code>gis:ServiceDataModel</code> URL	Description
SCTE236/V1	The <code>gis:ServiceDataModel</code> URL value required when CIS output shall contain the SCTE 236 Data Model Connector results (i.e., the <code>SCTE236BasicQueryResult</code> element) substituted for the <code>gis:BasicQueryResultAbstract</code> element.

The `gis:ServiceDataModel` value shall also be used in the `CISQueryRequest` message’s `gis:Query` element if the desired output includes the `SCTE236BasicQueryResult` substitute element substituted for the `gis:BasicQueryResultAbstract`.

B.4 Unique Qualifiers

SCTE 236 Data Model Connector implementations shall support a unique qualifier comprised of a `gis:UniqueQualifierDeclaration` element with a single `gis:QualifierDescription` element.

⁶ In the 2020 SCTE 130-4 revision, the CableLabs ADI 3.0 connector was replaced with the SCTE 236 connector. The new connector is in the same namespace and given a different element name avoiding any potential name collision issues.

The `@uniqueQualifierName` attribute of the `gis:UniqueQualifierDeclaration` element shall be the value “URIID” and the `@name` attribute of the `gis:QualifierDeclaration` shall be “uriID”. This value matches the metadata name for the `@uriId` attribute defined in [SCTE236].

Example 2 contains a unique qualifier declaration for the name “URIID” comprised of one qualifier declaration containing the name “uriId”.

```
<gis:UniqueQualifierDeclaration uniqueQualifierName="URIID">
  <gis:QualifierDeclaration name="Asset_URIID"/>
</gis:UniqueQualifierDeclaration>

<gis:QualifierDescription description="Core uriID" name="uriId" valueType="string">
  <gis:MaxLength>1024</gis:MaxLength>
</gis:QualifierDescription>
```

Example 2: SCTE 236 Metadata Data Model Unique Qualifier

CISQueryRequest messages utilizing the `gis:ServiceDataModel`, defined in Table 12, to query for specific [SCTE236] metadata assets shall use the unique qualifier declaration defined herein.

B.5 Query and Response

Basic query CISQueryRequest messages utilizing the `gis:ServiceDataModel` URL defined in Table 10 shall result in CISQueryResult messages containing SCTE236BasicQueryResult elements substituted for `gis:BasicQueryResultAbstract` elements.

Advanced queries are not supported by the SCTE 236 Metadata Data model Connector. Consequently, the Query element’s `gis:AdvancedQueryFilter` element and the `gis:QueryResults` element’s `gis:AdvancedQueryResult` element shall be omitted when the `gis:Query` element of the CISQueryRequest contains the `gis:ServiceDataModel` URL defined in Table 10.

B.6 Query Semantics

When the `@expandOutput` attribute of a Query message is set to false, the `adi3:ADI3` element shall contain a valid SCTE 236 `core:AssetType` containing a `@uriId` attribute only. When the `@expandOutput` attribute is set to true, the `adi3:ADI3` element shall contain a well formed SCTE 236 Metadata `core:AssetType` element. Table 11 defines when specific elements of the SCTE 236 Metadata `core:AssetType` element are to be used in the context of SCTE 236 Metadata Data Model Connector.

Table 11 - @expandOutput choices for SCTE 236 Data Model Connector

<code>@expandOutput</code> Value	Required Elements
true	<code>core:AssetType@uriId</code> <code>core:AssetType</code> (fully populated)
false	<code>core:AssetType@uriId</code>

The XML schema for the SCTE236BasicQueryResult element is illustrated in Figure 25.

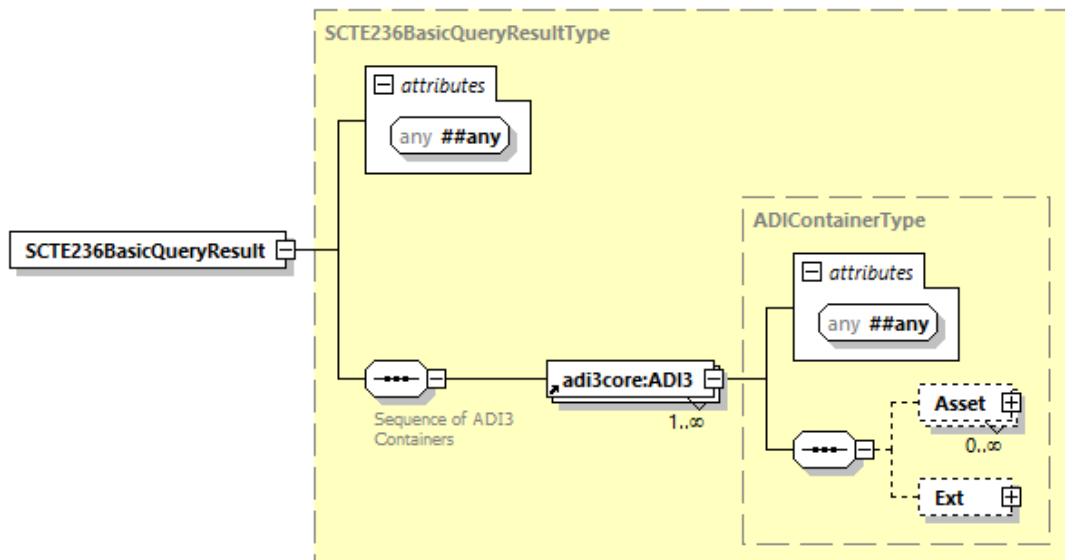

Figure 25 – SCTE 236 Metadata Data Model Connector XML Schema

`adi3:ADI3` [Required] – The `adi3:ADI3` element contains information on referenced assets. A full description of the `adi3:ADI3` element is outside of the scope of this document. See [SCTE236] for additional information.

Appendix C Content Forecasting Data Model Connector (Normative)

The following data model connector is optional and shall be used for accessing forecasting metadata. If a Content Forecasting Data Model implementation chooses to offer this specific data model implementation, this appendix shall be required, and all contents shall be considered normative.

Content Forecasting Data Model Connector implementations shall implement the complete set of Content Information Service interface defined herein.

C.1 ServiceDataModel URL

A CFS implementation offering this data model shall include the `gis:ServiceDataModel` URL, as defined in Table 12.

Table 12 - `gis:ServiceDataModel` Definition for Content Forecasting Data Model Connector

<code>gis:ServiceDataModel</code> URL	Description
ContentForecasting	The <code>gis:ServiceDataModel</code> value required when CFS output contains the Forecasting Data Model Connector results (i.e., the <code>ContentBasicQueryResult</code> element) substituted for the <code>gis:BasicQueryResultAbstract</code> element.

C.2 Unique Qualifiers

The Content Forecasting Data Model Connector does not define unique qualifier declarations for use in identifying assets. Instead, the Connector shares `gis:UniqueQualifiers` declarations with the underlying data model of the host CIS implementation. Discovery of unique qualifiers supported by the host implementation is done through the exchange of `CISListQualifiersRequest` and `CISListQualifiersResponse` messages as defined in section 11.9.

C.3 Qualifiers

Content Forecasting Data Model Connector implementations shall support the qualifiers defined in Table 13.

Table 13 - Content Forecasting Data Model Connector Qualifier Descriptions

Qualifier Name	Description	Type	Constraints
StartTime	Start date and time	<code>core:dateTimeTimezoneType</code>	
EndTime	End date and time	<code>core:dateTimeTimezoneType</code>	> StartTime
Region	Region name	string	length > 0
Owner	Owner name	string	length > 0

The type associated with the `StartTime` and `EndTime` qualifiers defined in Table 13 is a reference to the `gis:QualifierDescription` element `@valueType` defined in [SCTE130-8]. The actual type associated with the “`private:DateTime`” value shall be `core:DateTimeTimezoneType`.

Example 3 illustrates the definition of the qualifiers defined in Table 13.

```

<gis:QualifierDescription description="Start Time" name="StartTime"
valueType="private:DateTime"/>

<gis:QualifierDescription description="End Time" name="EndTime"
valueType="private:DateTime"/>

<gis:QualifierDescription description="Region" name="Region" valueType="string">
  <gis:MaxLength>1024</gis:MaxLength>
</gis:QualifierDescription>

<gis:QualifierDescription description="Owner" name="Owner" valueType="string">
  <gis:MaxLength>1024</gis:MaxLength>
</gis:QualifierDescription>

```

Example 3: Content Forecasting Qualifier Declarations

C.4 Query and Response

Basic query CISQueryRequest messages utilizing the gis:ServiceDataModel URL defined in Table 13 shall result in CISQueryResult messages containing ContentBasicQueryResult elements substituted for gis:BasicQueryResultAbstract elements.

Advanced queries are not supported by the Content Forecasting Data model Connector. Consequently, the gis:Query element's gis:AdvancedQueryFilter element and the gis:QueryResult element's gis:AdvancedQueryResult element shall be omitted when the gis:Query element of the CISQueryRequest contains the gis:ServiceDataModel URL defined in Table 12.

C.5 Query Semantics

When using the Content Forecasting Data Model Connector, the @expandOutput attribute of a gis:Query message shall be set to false and the ContentBasicQueryResult shall be structured as specified below in Figure 26.

C.6 ContentBasicQueryResult XML Schema

The XML schema for the ContentBasicQueryResult element is illustrated in Figure 26.

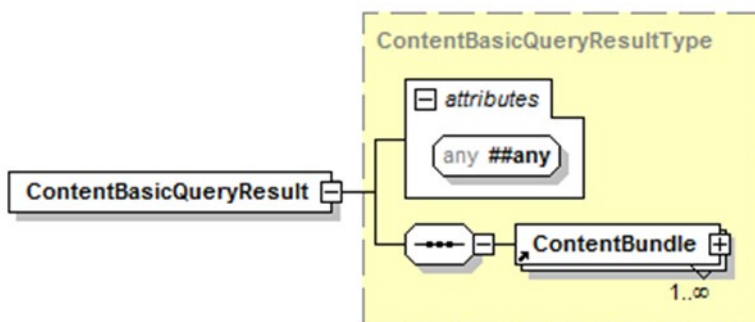

Figure 26 - Content Forecasting Data Model Connector XML Schema

@##any [Optional] – Any additional attributes from any namespace.

ContentBundle [Required] – A container for query results containing content information constrained by the dates and other information provided in the query. See section ContentBundle.

C.7 ContentBasicQueryResult Element Details

C.7.1 ContentBundle

The XML schema for the ContentBundle element is illustrated in Figure 27.

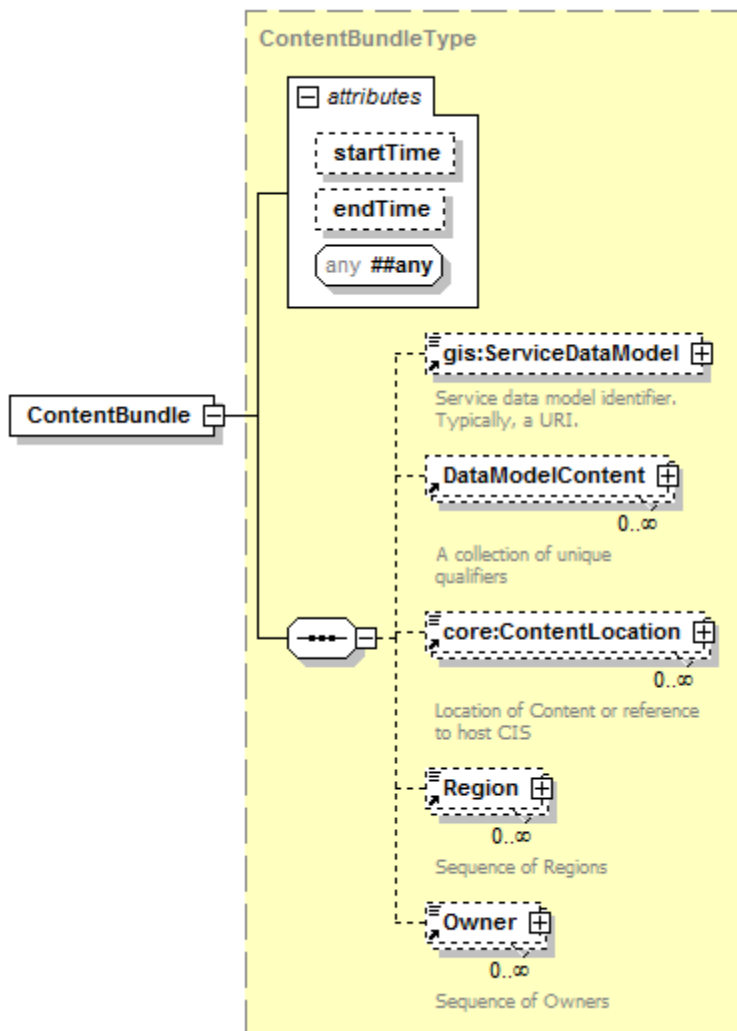

Figure 27 - ContentBundle XML Schema

@startTime [Optional, core:dateTimeTimezoneType]—No content referenced in the bundle shall be required before this Datetime.

@endTime [Optional, core:dateTimeTimezoneType]—No content referenced in the bundle shall be required after this Datetime.

@##any [Optional] – Any additional attributes from any namespace.

`gis:ServiceDataModel` [Optional]—An optional reference to a `ServiceDataModel` allowing the CIS client to format subsequent queries to CISs. See [SCTE130-8] for additional details.

`DataModelContent` [Optional]—A `DataModelContent` element containing an optional `gis:UniqueQualifier` element and an optional `core:ContentLocation` element. See section `DataModelContent` for additional details.

`core:ContentLocation` [Optional, `core:nonEmptyStringType`]—Specifies a location URL where the referenced Content should be located. This element, when supplied, shall provide a default value for the `core:ContentLocation` elements omitted from `DataModelContent` elements.

`Region` [Optional, `core:nonEmptyStringType`]—Specifies a sequence of areas for which this reference content shall be used. The definition or characteristics of Regions are not specified further in this standard. See section `Region` for additional information.

`Owner` [Optional, `core:nonEmptyStringType`]—Specifies a sequence of content rights holders associated with the referenced content. The definition or characteristics of owners are not specified further in this standard. See section `Owner` for additional information.

C.7.2 DataModelContent

The `DataModelContent` element contains asset qualifier and location information. The XML schema for the Content element is illustrated in Figure 28.

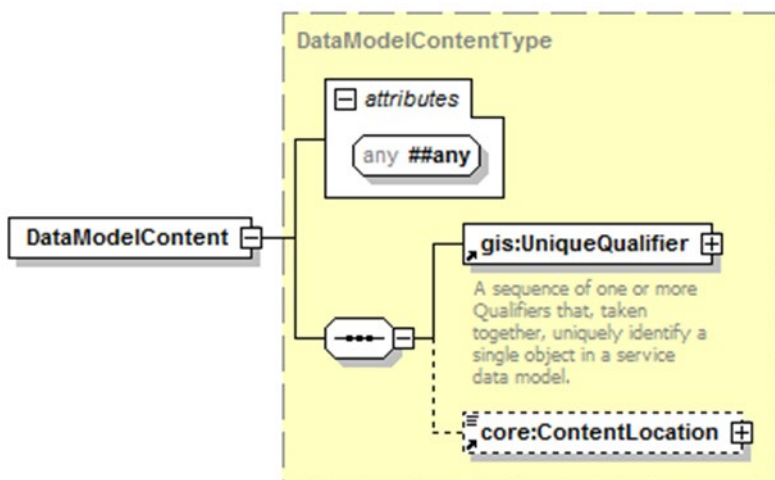

Figure 28 - DataModelContent XML Schema

`gis:UniqueQualifier` [Required]—A `gis:UniqueQualifier` element identifying an asset returned in the query. See [SCTE130-8] for additional information.

`core:ContentLocation` [Optional]—A `core:ContentLocation` element containing URL information for the asset. See [SCTE130-2] for additional information. This element overrides the value of the `core:ContentLocation` element provided in the `ContentBundle` element.

C.7.3 Region

The XML schema for the `Region` element is illustrated in Figure 29.

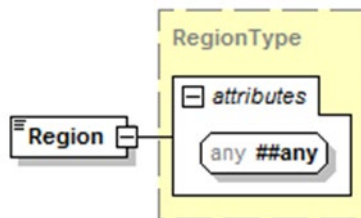

Figure 29 - Region XML Schema

@##any [Optional] – Any additional attributes from any namespace.

The Region element body contains a string identifier that includes the name of the region where the identified assets are required.

C.7.4 Owner

The XML schema for the Owner element is illustrated in Figure 30.

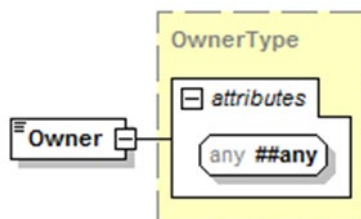

Figure 30 - Owner XML Schema

@##any [Optional] – Any additional attributes from any namespace.

The Owner element body contains a string identifier that includes ownership information for the identified assets.

Appendix D WSDL (Normative)

SCTE 130 Part 4 includes a separate WSDL document for the CIS and CIS client interfaces. See the WSDL document for details regarding the wsdl:portType definitions for the service endpoints along with the service definitions, binding types, and input/output parameter mappings. Table 1 specifies the normative WSDL XML namespace using the prefix ‘wsdl’. SCTE 130 Part 7 provides additional WSDL specification details. See [SCTE130-7] for more information. See the normative Part 4 WSDL document for all other details.

Appendix E Generic Data Model Connector (Informative)

A data connector schema is used to make a connection between the SCTE130 part 4 schema (defined herein) with external data models. The data connector defines a query result element that is connected to the `gis:BasicQueryResultAbstract` element through the use of XML substitution groups. A complete description of XML substitution group operations is outside the scope of this document.

In the following generic data connector schema, elements required to bridge to an external data model are in italics.

Note the inclusion of one or more namespaces is accomplished by declaring the namespace with a corresponding import statement. The element defined as a substitution group for a `gis:BasicQueryResultAbstract` element may contain any valid XML structure.

```
<?xml version="1.0" encoding="UTF-8"?>
<xsd:schema xmlns:xsd="http://www.w3.org/2001/XMLSchema"
  xmlns="http://www.scte.org/schemas/130-4/2011/cis/query"
  xmlns:gis="http://www.scte.org/schemas/130-8/2011/gis"
  xmlns:zzz="http://www.example.org/schema/zzz"
  targetNamespace="http://www.scte.org/schemas/130-4/2011/cis/query"
  elementFormDefault="qualified" attributeFormDefault="unqualified">

  <!-- Imports -->
  <xsd:import namespace="http://www.scte.org/schemas/130-8/2011/gis"
    schemaLocation="SCTE_130-8_2011.xsd"/>

  <xsd:import namespace="http://www.example.org/schema/zzz"
    schemaLocation="generic_ex_r1.xsd"/>

  <!-- Elements -->
  <xsd:element name="ZZZBasicQueryResult" type="ZZZBasicQueryResultType"
    substitutionGroup="gis:BasicQueryResultAbstract"/>

  <!-- Types -->
  <xsd:complexType name="ZZZBasicQueryResultType">
    <xsd:complexContent>
      <xsd:extension base="gis:BasicQueryResultAbstractType">

        <xsd:choice>
        <xsd:element ref="gis:UniqueQualifier" maxOccurs="unbounded"/>
        <xsd:element ref="zzz:ZZZ" maxOccurs="unbounded"/>
        </xsd:choice>

      </xsd:extension>
    </xsd:complexContent>
  </xsd:complexType>

  <!--additional supporting elements can go here →

</xsd:schema>
```

Appendix F List Qualifiers Request and Response Example (Informative)

Example 4 and Example 5 illustrate the use of the CISListQualifiersRequest and CISListQualifiersResponse messages. A CIS client may use these commands to discover the qualifiers supported by a CIS instance.

```
<CISListQualifiersRequest
  messageId="ABC123" identity="Identity" system="System" version="2.0"
  xmlns="http://www.scte.org/schemas/130-4/2011/cis"
  xmlns:core="http://www.scte.org/schemas/130-2/2008a/core"
  xmlns:gis="http://www.scte.org/schemas/130-8/2011/gis">
  <core:InitiatorData>Super special vendor sauce</core:InitiatorData>
  <gis:ServiceDataModel>CLVOD_1.1/SCTE/V1</gis:ServiceDataModel>
</CISListQualifiersRequest>
```

Example 4: CISListQualifiersRequest

Example 4 is a CISListQualifiersRequest message that contains a reference to a specific gis:ServiceDataModel type. Depending on the service model type, a CIS implementation may respond with a completely different set of standard and unique qualifiers for the model referenced in the CISListQualifiersRequest.

```
<CISListQualifiersResponse
  messageRef="ABC123" messageId="123ABC" identity="Identity" system="System" version="2.0"
  xmlns="http://www.scte.org/schemas/130-4/2011/cis"
  xmlns:core="http://www.scte.org/schemas/130-2/2008a/core"
  xmlns:gis="http://www.scte.org/schemas/130-8/2011/gis">
  <core:InitiatorData>Super special vendor sauce</core:InitiatorData>
  <core:StatusCode class="0">
    <core:Note>Qualifier list generation successful.</core:Note>
  </core:StatusCode>

  <gis:BasicQueryDataModelDescription>
    <gis:ServiceDataModel>CLVOD_1.1/SCTE/V1</gis:ServiceDataModel>

    <!-- Unique qualifiers declaration -->
    <gis:UniqueQualifierDeclaration uniqueQualifierName="PAID">
      <gis:QualifierDeclaration name="Asset_ID"/>
      <gis:QualifierDeclaration name="Provider_ID"/>
    </gis:UniqueQualifierDeclaration>

    <!-- Unique qualifier description -->
    <gis:QualifierDescription description="Asset ID" name="Asset_ID" valueType="string">
      <gis:MaxLength>20</gis:MaxLength>
    </gis:QualifierDescription>

    <!-- Unique qualifier description -->
    <gis:QualifierDescription description="Provider ID" name="Provider_ID" valueType="string">
```

```

        <gis:MaxLength>20</gis:MaxLength>
    </gis:QualifierDescription>

    <!-- Non-unique qualifier descriptions -->
    <gis:QualifierDescription description="Provider" name="Provider" valueType="string"/>
    <gis:QualifierDescription description="Product" name="Product" valueType="string"/>
    <gis:QualifierDescription description="Asset Name" name="AssetName" valueType="string"/>
    <gis:QualifierDescription description="Asset Class" name="AssetClass" valueType="string"/>
</gis:BasicQueryDataModelDescription>
</CISListQualifiersResponse>

```

Example 5: CISListQualifiersResponse

Example 5 includes a compound unique qualifier (Asset_ID, Provider_ID) as a unique qualifier for each qualified asset. This example also contains additional qualifiers that can be used by a CIS client as input into CISQueryRequest. For instance, a CIS may issue a query for all assets that belong to product type “MTOD”.

Appendix G Query Request and Response (Informative)

The following examples illustrate the use of the CISQueryRequest and response messages. Example 6 contains a simple CISQueryRequest that uses the basic query mechanism to query for all assets with a Asset_ID value of “ABCD0000000000000001”. Note that the name of the gis:BasicQueryElement is “Asset_ID”, indicating that the gis:QualifierDescription with the name “Asset_ID” should be used to affect the search.

```

<CISQueryRequest
  messageId="MessageId" identity="Identity" system="System" version="2.0"
  xmlns="http://www.scte.org/schemas/130-4/2011/cis"
  xmlns:core="http://www.scte.org/schemas/130-2/2008a/core"
  xmlns:gis="http://www.scte.org/schemas/130-8/2011/gis" >
  <core:InitiatorData>Save this String</core:InitiatorData>
  <gis:Query queryId="1234" expandOutput="false" resultSetSizeOnly="false">
    <gis:ServiceDataModel> http://SuperDemographics.com </gis:ServiceDataModel>
    <gis:BasicQueryFilter op="include">
      <gis:BasicFilterElement value="ABCD0000000000000001" name="Asset_ID"
        valueIsRegex="false"/>
    </gis:BasicQueryFilter>
  </gis:Query>
</CISQueryRequest>

```

Example 6: CISQueryRequest

Example 7 contains the response message for the query from Example 6.

```

<CISQueryResponse messageId="123ABC" identity="Identity" system="System"
  version="2.0"
  xmlns="http://www.scte.org/schemas/130-4/2011/cis"
  xmlns:core="http://www.scte.org/schemas/130-2/2008a/core"

```

```

xmlns:gis="http://www.scte.org/schemas/130-8/2011/gis">
  <core:InitiatorData>Special vendor sauce</core:InitiatorData>
  <core:StatusCode class="0">
    <core:Note>Successful query</core:Note>
  </core:StatusCode>
  <gis:QueryResult resultSetSize="1" queryRef="1" totalResultSetSize="1">
    <gis:BasicQueryResult>
      <gis:UniqueQualifier uniqueQualifierNameRef="PAID">
        <gis:Qualifier value="ABCD0000000000000001" name="Asset_ID"/>
        <gis:Qualifier value="provider.com" name="Provider_ID"/>
      </gis:UniqueQualifier>
    </gis:BasicQueryResult>
  </gis:QueryResult>
</CISQueryResponse>

```

Example 7: CISQueryResponse

Example 8 illustrates a CISQueryRequest that specifies expanded output results as well as the use of the VOD Metadata 1.1 Data Model Connector by adding the proper URL to the gis:ServiceDataModel element.

```

<CISQueryRequest
  messageId="MessageId" identity="Identity" system="System" version="2.0"
  xmlns="http://www.scte.org/schemas/130-4/2011/cis"
  xmlns:core="http://www.scte.org/schemas/130-2/2008a/core"
  xmlns:gis="http://www.scte.org/schemas/130-8/2011/gis">
  <core:InitiatorData>Save this String</core:InitiatorData>
  <gis:Query queryId="1234" expandOutput="true" resultSetSizeOnly="false">
    <gis:ServiceDataModel> CLVOD1.1/SCTE/V1 </gis:ServiceDataModel>
    <gis:BasicQueryFilter op="include">
      <gis:BasicFilterElement value="ABCD0000000000000001" name="Asset_ID"
        valueIsRegex="false"/>
    </gis:BasicQueryFilter>
  </gis:Query>
</CISQueryRequest>

```

Example 8: CISQueryRequest for expanded output

Example 9 contains the output that would be returned had the @expandOutput attribute been set to “true”.

```

<CISQueryResponse messageRef="messageRef"
  messageId="messageId"
  identity="identity"
  system="system"
  version="2.0"
  xmlns="http://www.scte.org/schemas/130-4/2011/cis"
  xmlns:core="http://www.scte.org/schemas/130-2/2008a/core"
  xmlns:gis="http://www.scte.org/schemas/130-8/2011/gis"
  xmlns:query="http://www.scte.org/schemas/130-4/2011/cis/query">
  <core:InitiatorData>Special vendor sauce</core:InitiatorData>
  <core:StatusCode class="0">

```

```

    <core:Note>Query successful</core:Note>
  </core:StatusCode>
  <gis:QueryResult resultSetSize="1" queryRef="1234" totalResultSetSize="1">
    <query:VOD11BasicQueryResult>
      <core:Content>
        <core:Ext>
          <ADI>
            <Metadata>
              <AMS Version_Major="1"
                Provider="NBCU"
                Product="MOD"
                Provider_ID="Provider.com"
                Version_Minor="1"
                Description="A Package"
                Creation_Date="2004-06-08"
                Asset_Class="package"
                Asset_ID="ABCD0000000000000001"
                Asset_Name="Guide To Life Package"/>
              <App_Data App="MOD" Name="Metadata_Spec_Version"
                Value="CableLabsVOD1.1"/>
            </Metadata>
            <Asset>
              <Metadata>
                <AMS Version_Major="1"
                  Provider="Provider"
                  Product="MOD"
                  Provider_ID="Provider.com"
                  Version_Minor="0"
                  Description="A Title"
                  Creation_Date="2004-06-08"
                  Asset_Class="title"
                  Asset_ID="ABCD0000000000000002"
                  Asset_Name="Guide to Life Title"/>
                <App_Data App="MOD" Name="Type" Value="title"/>
                <App_Data App="MOD" Name="Title" Value="Guide To Life"/>
              </Metadata>
            </Asset>
            <Metadata>
              <AMS Version_Major="1"
                Provider="Provider"
                Product="MOD"
                Provider_ID="Provider.com"
                Version_Minor="0"
                Description="A Movie"
                Creation_Date="2004-06-08"
                Asset_Class="movie"
                Asset_ID="ABCD0000000000000003"
                Asset_Name="Guide to Life Movie"/>
              <App_Data App="MOD" Name="Type" Value="Movie"/>
            </Metadata>
          </Asset>
        </ADI>
      </core:Ext>
    </core:Content>
  </query:VOD11BasicQueryResult>

```

```
</gis:QueryResult>
</CISQueryResponse>
```

Example 9: CISQueryResponse

Example 9 contains the complete metadata listing for the asset requested in the Example 6 query. In this case, the @expandOutput attribute of the CISQueryRequest have been set to “true” and the gis:ServiceDataModel URL has been set to CLVOD_1.1/SCTE/V1, indicating that the VOD Metadata 1.1 Data Model Connector should be utilized and the entire metadata listing for the asset should be provided in the output.

Example 10 contains a complete CISQueryRequest utilizing the Content Forecasting ServiceDataModel URL. This is an example of a request for information on linear spots within particular regions and for a specific start time.

```
<CISQueryRequest messageId="messageId" identity="identity" system="system" version="2.0"
  xmlns="http://www.scte.org/schemas/130-4/2011/cis"
  xmlns:gis="http://www.scte.org/schemas/130-8/2011/gis"
  xmlns:query="http://www.scte.org/schemas/130-4/2011/cis/query"
  xmlns:core="http://www.scte.org/schemas/130-2/2008a/core">
  <gis:Query queryId="1234">
    <gis:ServiceDataModel>ContentForecasting</gis:ServiceDataModel>
    <gis:BasicQueryFilter>
      <gis:BasicFilterElement name="StartTime" value="2011-04-01T00:00:00.0-04:00"/>
      <gis:BasicFilterElement name="Region" value="DSW"/>
    </gis:BasicQueryFilter>
    <gis:BasicQueryFilter>
      <gis:BasicFilterElement name="StartTime" value="2011-04-01T00:00:00.0-04:00"/>
      <gis:BasicFilterElement name="Region" value="DHL"/>
    </gis:BasicQueryFilter>
  </gis:Query>
</CISQueryRequest>
```

Example 10: Content Forecasting Data Model CISQueryRequest

Example 11 contains the complete response to the query illustrated in Example 10.

```
<CISQueryResponse messageRef="messageRef" messageId="messageId" identity="identity"
  system="system" version="2.0"
  xmlns="http://www.scte.org/schemas/130-4/2011/cis"
  xmlns:gis="http://www.scte.org/schemas/130-8/2011/gis"
  xmlns:query="http://www.scte.org/schemas/130-4/2011/cis/query"
  xmlns:core="http://www.scte.org/schemas/130-2/2008a/core" >
  <core:InitiatorData>Save This String</core:InitiatorData>
  <core:StatusCode class="0">
    <core:Note>Query successful</core:Note>
  </core:StatusCode>
  <gis:QueryResult resultSetSize="1" queryRef="1234" totalResultSetSize="1">
    <query:ContentBasicQueryResult>
      <query:ContentBundle startTime="2011-04-10T00:00:00.0-04:00">
        <query:DataModelContent>
```

```

        <gis:UniqueQualifier>
            <gis:Qualifier name="SpotId" value="N24782340001"/>
        </gis:UniqueQualifier>
    </query:DataModelContent>
    <query:DataModelContent>
        <gis:UniqueQualifier>
            <gis:Qualifier name="SpotId" value="N24782340009"/>
        </gis:UniqueQualifier>
    </query:DataModelContent>

    <core:ContentLocation>http://www.myprovider.com/server/DSW</core:ContentLocation>
    <query:Region>DSW</query:Region>
    <query:Owner>National</query:Owner>

</query:ContentBundle>

<query:ContentBundle startTime="2011-04-10T00:00:00.0-04:00">
    <query:DataModelContent>
        <gis:UniqueQualifier>
            <gis:Qualifier name="SpotId" value="N24782340010"/>
        </gis:UniqueQualifier>
    </query:DataModelContent>
    <query:DataModelContent>
        <gis:UniqueQualifier>
            <gis:Qualifier name="SpotId" value="N24782340012"/>
        </gis:UniqueQualifier>
    </query:DataModelContent>

    <core:ContentLocation>http://www.myprovider.com/server/WDL</core:ContentLocation>
    <query:Region>WDL</query:Region>
    <query:Owner>National</query:Owner>
</query:ContentBundle>

</query:ContentBasicQueryResult>
</gis:QueryResult>
</CISQueryResponse>

```

Example 11: Content Forecasting Data Model CISQueryResponse